



Modbus Gateway

ICDM-RX/MOD-ST/RJ45-DIN

- Web-based configuration
- DIN-rail mounting and screw terminal connections
- RS-232/422/485 software selectable interfaces
- NEMA TS2 Certified
- Pure Modbus, multiple Modbus master and slave types , remote, local, and private devices

Modbus Gateway 1-port DIN Rail Screw Terminal



Function

The ICDM-RX/MOD product family provides an innovative network-wide Modbus connectivity from a wide variety of Modbus masters to a wide variety of local and remote Modbus slaves. Advanced features include master-to-master communication, private serial bus connectivity, write protection, and device ID aliasing. With simplified configuration pages and advanced routing, it provides unmatched Modbus connectivity. The integrated webserver enables complete configuration of all module parameters like serial interface, baud rate, data bits, stop bits, or flow control. Products are available in different versions for DB9 or screw terminal connection.

Dimensions

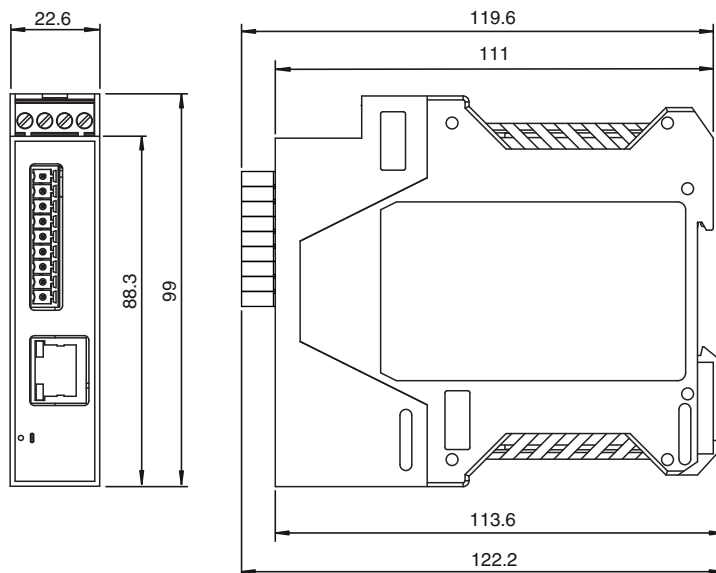

Technical Data

General specifications

UL File Number E360395

Functional safety related parameters

Release date: 2021-03-31 Date of issue: 2021-03-31 Filename: 70104883_eng.pdf

Refer to "General Notes Relating to Pepperl+Fuchs Product Information".

Pepperl+Fuchs Group
www.pepperl-fuchs.com

USA: +1 330 486 0001
fa-info@us.pepperl-fuchs.com

Germany: +49 621 776 1111
fa-info@de.pepperl-fuchs.com

Singapore: +65 6779 9091
fa-info@sg.pepperl-fuchs.com

PF PEPPERL+FUCHS

Technical Data

MTBF	61.4 a
Indicators/operating means	
LED indication	see manual
Electrical specifications	
Rated operating voltage	U_e 5 ... 30 V DC
General information	Redundant power
Nominal voltage	24 V DC
Interface	
Interface type	Software selectable interfaces: RS-232 , RS-422 , RS-485 (2 and 4-wire)
Physical	1 x screw terminal
Protocol	MODBUS
Supported baud rates	300 bps to 230Kbps
Interface 1	
Interface type	Industrial Ethernet
Physical	1 x RJ45
Protocol	MODBUS TCP/IP
Additional protocols	ARP, BOOTP, DHCP/RARP, HTTP, HTTPS, SSH, SSL/TLS, ICMP, RFC 1006 (ISO over TCP), SNMP (MIB-II), TCP/IP & UDP socket services, Telnet, and TFTP, and supports IP multicast data transmission
Transfer rate	10/100 Mbps
Directive conformity	
Electromagnetic compatibility	
Directive 2014/30/EU	EN 61000-6-2 , EN 55024 , EN 61000-6-4 , EN 55032
Standard conformity	
Degree of protection	NEMA TS2
Electrical safety	CSA C22.2 No. 61010-1-12 / CSA C22.2 No. 61010-1-201 UL 61010-1 / UL 61010-1-201
Emitted interference	EN 61000-6-4, EN 55032, FCC Part 15 Subpart B, ICES-003, AS/NZS CISPR 32
Noise immunity	EN 61000-6-2 , EN 55024
Ambient conditions	
Ambient temperature	-40 ... 75 °C (-40 ... 167 °F)
Storage temperature	-40 ... 85 °C (-40 ... 185 °F)
Relative humidity	max. 95 %
Altitude	0 ... 3048 m
Mechanical specifications	
Housing length	119.3 mm
Housing width	22.9 mm
Housing height	99.1 mm
Degree of protection	IP20
Connection	Power Supply: screw terminals Fieldbus: 1 x RJ45 Inputs/outputs: 9-pin screw terminal block
Material	
Housing	Polyamide, UL94V-0
Mass	113.4g
Construction type	Cabinet module
Mounting	DIN mounting rail

Release date: 2021-03-31 Date of issue: 2021-03-31 Filename: 70104883_eng.pdf

Connection

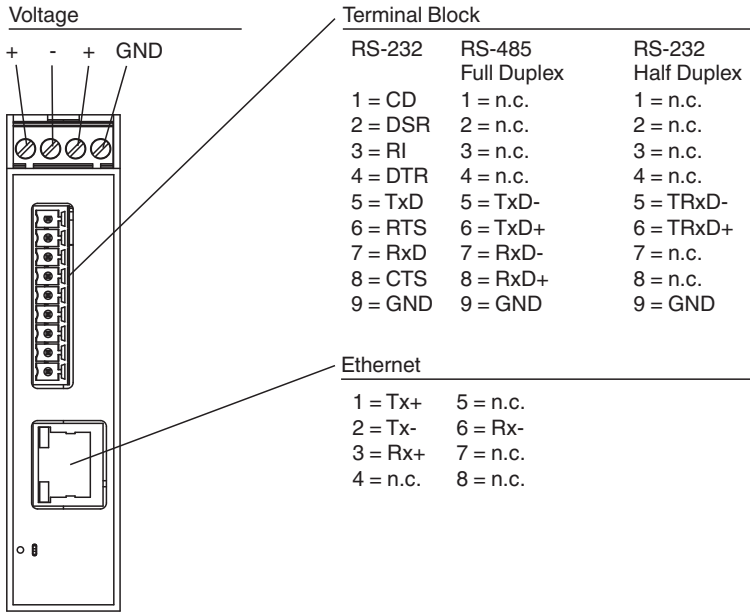

Assembly

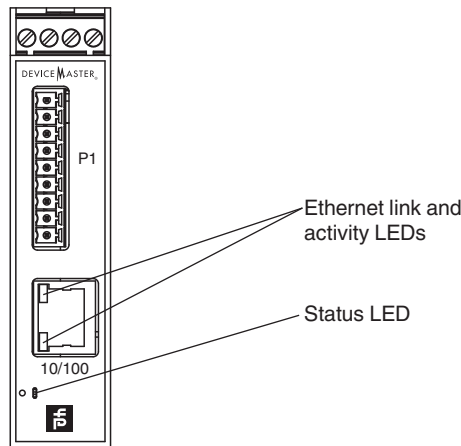

Accessories

	V45-G-C5-GN1M-PUR-E1S	Ethernet bus cable male cordset single-ended RJ45, 4-pin, PUR cable green, Cat5e, shielded, UL approved, drag chain suitable
	V45-G-C5-GN3M-PUR-E1S	Ethernet bus cable male cordset single-ended RJ45, 4-pin, PUR cable green, Cat5e, shielded, UL approved, drag chain suitable
	V45-G-C5-GN10M-PUR-E1S	Ethernet bus cable male cordset single-ended RJ45, 4-pin, PUR cable green, Cat5e, shielded, UL approved, drag chain suitable
	V45-G-C5-GN1M-PUR-E1S-V45-G	Ethernet bus cable RJ45 to RJ45 PROFINET-coded, 4-pin, PUR cable green, Cat5e, shielded, UL approved, drag chain suitable
	V45-G-C5-GN3M-PUR-E1S-V45-G	Ethernet bus cable RJ45 to RJ45 PROFINET-coded, 4-pin, PUR cable green, Cat5e, shielded, UL approved, drag chain suitable
	V45-G-C5-GN10M-PUR-E1S-V45-G	Ethernet bus cable RJ45 to RJ45 PROFINET-coded, 4-pin, PUR cable green, Cat5e, shielded, UL approved, drag chain suitable

Release date: 2021-03-31 Date of issue: 2021-03-31 Filename: 70104883_eng.pdf

Accessories**V45-G-C5-GN20M-PUR-
E1S-V45-G**

Ethernet bus cable RJ45 to RJ45 PROFINET-coded, 4-pin, PUR cable green, Cat5e, shielded, UL approved, drag chain suitable