

# Serial Device Server

## ICDM-RX/TCP-16RJ45/RJ45-RM



- Web-based configuration
- RS-232/422/485 software selectable interfaces
- NEMA TS2 Certified
- TCP/IP & UDP Socket Services
- Device drivers (Windows and Linux)
- Rack mount with RJ45 serial connectors

Device Server 16-port rack mount RJ45



### Function

The ICDM-RX/TCP product family enables the connection of serial devices (RS-232 / RS-422 / RS-485) using a device driver (Windows or Linux) or Ethernet TCP/IP devices using socket services to an industrial Ethernet network. The integrated webserver enables complete configuration of all module parameters like serial interface, baud rate, parity, data bits, stop bits, or flow control. Products are available in different versions for DB9 or screw terminal connection.

### Dimensions

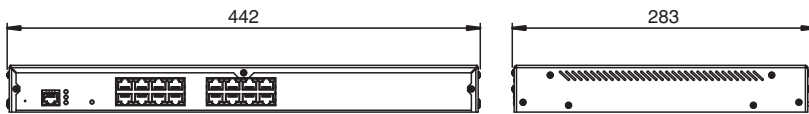

UNIT HEIGHT = 43.7

### Technical Data

#### General specifications

UL File Number E185802

#### Functional safety related parameters

MTBF 15.5 a

#### Indicators/operating means

LED indication see manual

#### Electrical specifications

Rated operating voltage  $U_e$  90 ... 260 V AC

#### Interface

Interface type Software selectable interfaces: RS-232 , RS-422 , RS-485 (2 and 4-wire)

Physical 16 x RJ45

Protocol Raw serial

Supported baud rates 300 bps to 230Kbps

#### Interface 1

Interface type Industrial Ethernet

Physical 1 x RJ45

Protocol TCP/IP

Additional protocols ARP, BOOTP, DHCP/RARP, HTTP, HTTPS, SSH, SSL/TLS, ICMP, RFC 1006 (ISO over TCP), SNMP (MIB-II), TCP/IP & UDP socket services, Telnet, and TFTP, and supports IP multicast data transmission

Transfer rate 10/100 Mbps

#### Directive conformity

Release date: 2021-06-16 Date of issue: 2021-06-16 Filename: 70114048\_eng.pdf

Refer to "General Notes Relating to Pepperl+Fuchs Product Information".

Pepperl+Fuchs Group  
www.pepperl-fuchs.com

USA: +1 330 486 0001  
fa-info@us.pepperl-fuchs.com

Germany: +49 621 776 1111  
fa-info@de.pepperl-fuchs.com

Singapore: +65 6779 9091  
fa-info@sg.pepperl-fuchs.com

**PEPPERL+FUCHS**

**Technical Data**

Electromagnetic compatibility	
Directive 2014/30/EU	EN 55024 , EN 55032
<b>Standard conformity</b>	
Electrical safety	EN 62368-1:2014-08
Emitted interference	EN 55032, FCC Part 15 Subpart B, ICES-003, AS/NZS CISPR 32
Noise immunity	EN 55024
<b>Ambient conditions</b>	
Ambient temperature	-40 ... 75 °C (-40 ... 167 °F)
Storage temperature	-40 ... 85 °C (-40 ... 185 °F)
Relative humidity	max. 95 %
Altitude	0 ... 3048 m
<b>Mechanical specifications</b>	
Housing length	438.2 mm
Housing width	273.4 mm
Housing height	44.2 mm
Degree of protection	IP20
Connection	Internal power supply: US and EURO cords Fieldbus: 1 x RJ45 Inputs/outputs: 16 x RJ45
<b>Material</b>	
Housing	steel, black coated
Mass	2.83kg
Construction type	Cabinet module
Mounting	Rack mount

**Wiring Diagram**

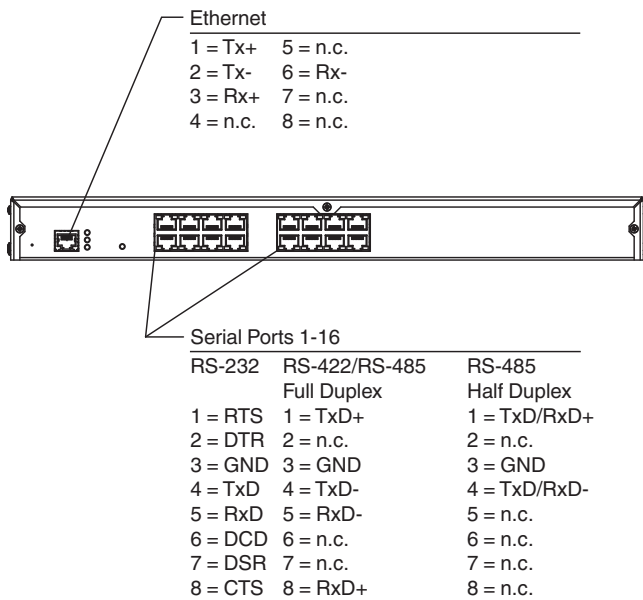



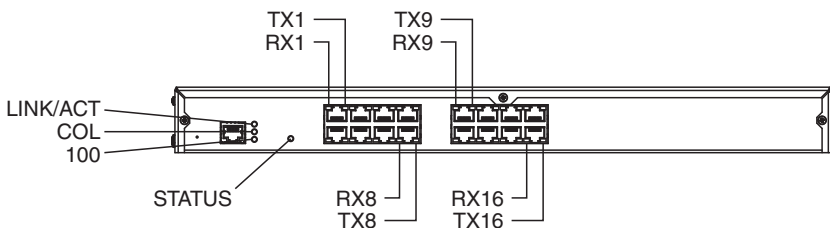



**Assembly**



Release date: 2021-06-16 Date of issue: 2021-06-16 Filename: 70114048\_eng.pdf

Refer to "General Notes Relating to Pepperl+Fuchs Product Information".

## Accessories

	<b>V45-G-C5-GN1M-PUR-E1S</b>	Ethernet bus cable male cordset single-ended RJ45, 4-pin, PUR cable green, Cat5e, shielded, UL approved, drag chain suitable
	<b>V45-G-C5-GN3M-PUR-E1S</b>	Ethernet bus cable male cordset single-ended RJ45, 4-pin, PUR cable green, Cat5e, shielded, UL approved, drag chain suitable
	<b>V45-G-C5-GN10M-PUR-E1S</b>	Ethernet bus cable male cordset single-ended RJ45, 4-pin, PUR cable green, Cat5e, shielded, UL approved, drag chain suitable
	<b>V45-G-C5-GN1M-PUR-E1S-V45-G</b>	Ethernet bus cable RJ45 to RJ45 PROFINET-coded, 4-pin, PUR cable green, Cat5e, shielded, UL approved, drag chain suitable
	<b>V45-G-C5-GN3M-PUR-E1S-V45-G</b>	Ethernet bus cable RJ45 to RJ45 PROFINET-coded, 4-pin, PUR cable green, Cat5e, shielded, UL approved, drag chain suitable
	<b>V45-G-C5-GN10M-PUR-E1S-V45-G</b>	Ethernet bus cable RJ45 to RJ45 PROFINET-coded, 4-pin, PUR cable green, Cat5e, shielded, UL approved, drag chain suitable
	<b>V45-G-C5-GN20M-PUR-E1S-V45-G</b>	Ethernet bus cable RJ45 to RJ45 PROFINET-coded, 4-pin, PUR cable green, Cat5e, shielded, UL approved, drag chain suitable