



Ethernet switch unmanaged gigabit ICRL-U-4RJ45/SFP-G-DIN

- Four - Gigabit RJ45 ports and one Gigabit SFP slot
- Rugged housing for use in harsh environments
- 9K bytes jumbo frame for large file transfers
- Power event alarm
- Wide power input 10-60V DC
- Suitable for PROFINET IO and EtherNet/IP

Ethernet unmanaged switch with 4 RJ45 gigabit ports, one gigabit SFP slot and fault alarm



Function

The ICRL-U-4RJ45/SFP-G-DIN is a compact unmanaged industrial switch with four 10/100/1000BASE-T(X) and one 1000BASE-F(X) ports, which ensures high switching performance and easy installation. Along with its high switching performance, it supports multiple internal performance features, such as 9K bytes Jumbo Frame, Flow Control, it ensures quality traffic transmission. The switch is designed for operating reliably under harsh environments, it supports one alarm relay to indicate fault conditions when a power failure occurs, users can quickly handle the emergency and shorten the failover time. It has an IP31 rugged mental housing that provides great injection protection and heat dispersion capability that supports a wide operating temperature range, and it complies to EN50121-4 Track Side Standard so that can ensure the EMC protection capability.

Dimensions

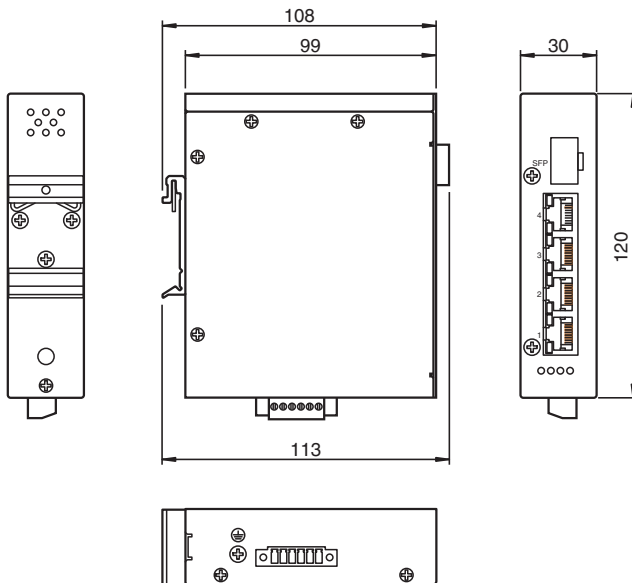

Technical Data

General specifications

UL File Number E185778

Functional safety related parameters

Release date: 2021-03-15 Date of issue: 2021-03-15 Filename: 70114055_eng.pdf

Refer to "General Notes Relating to Pepperl+Fuchs Product Information".

Pepperl+Fuchs Group
www.pepperl-fuchs.com

USA: +1 330 486 0001
fa-info@us.pepperl-fuchs.com

Germany: +49 621 776 1111
fa-info@de.pepperl-fuchs.com

Singapore: +65 6779 9091
fa-info@sg.pepperl-fuchs.com

PF PEPPERL+FUCHS

Technical Data

MTBF		45.3 years
Ethernet Interface		
Auto-MDI(-X)		yes
Autonegotiation		yes
Ethernet Interface		Industrial Ethernet
Transfer rate		10BASE-T, 100BASE-TX, 1000BASE-T
Cable type		Category 5e or better
Standards		
IEEE 802.3 10BASE-T		yes
IEEE 802.3u 100BASE-TX		yes
IEEE 802.3x Flow Control and Back-pressure		yes
IEEE 802.3ab 1000BASE-T		yes
Indicators/operating means		
LED indication		see manual
Electrical specifications		
Rated operating voltage	U _e	10 ... 60 V DC
Power consumption		3.6 W
General information		Redundant power, power fault alarm, relay output rating 1A Max. @ 24V DC
Nominal voltage		24 V DC
Interface 1		
Physical		RJ45
Transfer rate		10/100/1000 Mbps
Inputs/Outputs		
Number/Type		4 x RJ45 , 1 x SFP
Directive conformity		
Electromagnetic compatibility		
Directive 2014/30/EU		EN61000-6-2, EN55024 , EN61000-6-4, EN55032
Standard conformity		
Emitted interference		EN 55032, FCC Part 15 Subpart B, ICES-003, AS/NZS CISPR 32
Noise immunity		EN 55024, EN61000-6-2
Ambient conditions		
Ambient temperature		-25 ... 70 °C (-13 ... 158 °F)
Storage temperature		-40 ... 85 °C (-40 ... 185 °F)
Relative humidity		max. 95 %
Altitude		0 ... 3048 m
Mechanical specifications		
Degree of protection		IP30
Connection		Power Supply Terminal Block Ethernet 5 x RJ45
Material		
Housing		aluminium, black
Mass		650 g
Construction type		Cabinet module
Mounting		DIN rail or direct panel mounting

Release date: 2021-03-15 Date of issue: 2021-03-15 Filename: 70114055_eng.pdf

Refer to "General Notes Relating to Pepperl+Fuchs Product Information".

Pepperl+Fuchs Group
www.pepperl-fuchs.comUSA: +1 330 486 0001
fa-info@us.pepperl-fuchs.comGermany: +49 621 776 1111
fa-info@de.pepperl-fuchs.comSingapore: +65 6779 9091
fa-info@sg.pepperl-fuchs.com

PEPPERL+FUCHS

Wiring Diagram

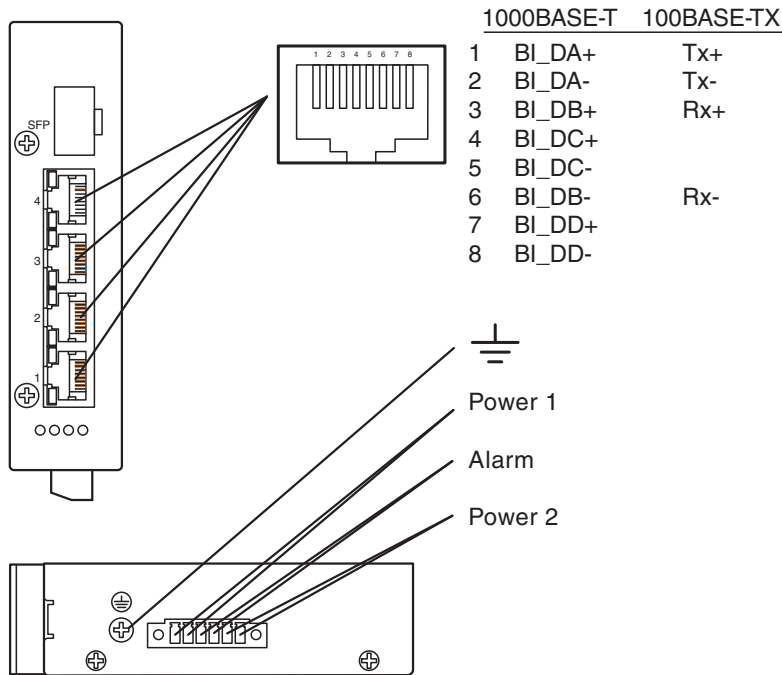

Indication

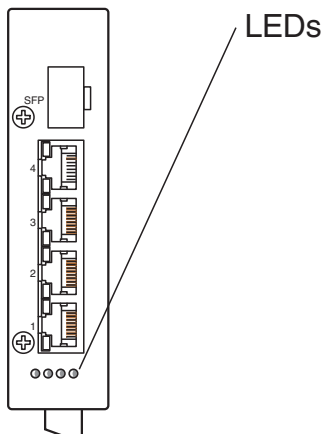





















Accessories

	V45-G-C5-GN1M-PUR-E1S	Ethernet bus cable male cordset single-ended RJ45, 4-pin, PUR cable green, Cat5e, shielded, UL approved, drag chain suitable
	V45-G-C5-GN3M-PUR-E1S	Ethernet bus cable male cordset single-ended RJ45, 4-pin, PUR cable green, Cat5e, shielded, UL approved, drag chain suitable
	V45-G-C5-GN10M-PUR-E1S	Ethernet bus cable male cordset single-ended RJ45, 4-pin, PUR cable green, Cat5e, shielded, UL approved, drag chain suitable
	V45-G-C5-GN1M-PUR-E1S-V45-G	Ethernet bus cable RJ45 to RJ45 PROFINET-coded, 4-pin, PUR cable green, Cat5e, shielded, UL approved, drag chain suitable
	V45-G-C5-GN3M-PUR-E1S-V45-G	Ethernet bus cable RJ45 to RJ45 PROFINET-coded, 4-pin, PUR cable green, Cat5e, shielded, UL approved, drag chain suitable

Release date: 2021-03-15 Date of issue: 2021-03-15 Filename: 70114055_eng.pdf

Refer to "General Notes Relating to Pepperl+Fuchs Product Information".

Accessories









	V45-G-C5-GN10M-PUR-E1S-V45-G	Ethernet bus cable RJ45 to RJ45 PROFINET-coded, 4-pin, PUR cable green, Cat5e, shielded, UL approved, drag chain suitable
	V45-G-C5-GN20M-PUR-E1S-V45-G	Ethernet bus cable RJ45 to RJ45 PROFINET-coded, 4-pin, PUR cable green, Cat5e, shielded, UL approved, drag chain suitable
	SFP-M-2KM-F-N	Multi-mode 2KM 100BASE-FX Fast Ethernet Fiber SFP
	SFP-M-2KM-F-W	Multi-mode 2KM 100BASE-FX Fast Ethernet Fiber SFP
	SFP-M-2KM-G-W	Multi-mode 2KM 100BASE-LX Gigabit Ethernet Fiber SFP
	SFP-M-550M-G-N	Multi-mode 550m 1000BASE-SX Gigabit Ethernet Fiber SFP
	SFP-M-550M-G-W	Multi-mode 550m 1000BASE-SX Gigabit Ethernet Fiber SFP
	SFP-S-100KM-F-W	Single-mode 100KM 100BASE-ZX Fast Ethernet Fiber SFP
	SFP-S-10KM-G-N	Single-mode 10KM 1000BASE-LX Gigabit Ethernet Fiber SFP
	SFP-S-10KM-G-W	Single-mode 10KM 1000BASE-LX Gigabit Ethernet Fiber SFP
	SFP-S-10KM-G-W-BIDI-A	Single-mode BiDi-A 10KM 1000BASE-LX Gigabit Ethernet Fiber SFP
	SFP-S-10KM-G-W-BIDI-B	Single-mode BiDi-B 10KM 1000BASE-LX Gigabit Ethernet Fiber SFP
	SFP-S-110KM-G-W	Single-mode 110KM 1000BASE-UZX Gigabit Ethernet Fiber SFP
	SFP-S-120KM-F-W	Single-mode 120KM 100BASE-FX Fast Ethernet Fiber SFP
	SFP-S-20KM-F-W	Single-mode 20KM 100BASE-FX Fast Ethernet Fiber SFP
	SFP-S-20KM-F-W-BIDI-A	Single-mode BiDi-A 20KM 100BASE-BX Fast Ethernet Fiber SFP
	SFP-S-20KM-F-W-BIDI-B	Single-mode BiDi-B 20KM 100BASE-BX Fast Ethernet Fiber SFP
	SFP-S-20KM-G-W	Single-mode 20KM 1000BASE-LX Gigabit Ethernet Fiber SFP
	SFP-S-20KM-G-W-BIDI-A	Single-mode BiDi-A 20KM 1000BASE-LX Gigabit Ethernet Fiber SFP
	SFP-S-20KM-G-W-BIDI-B	Single-mode BiDi-B 20KM 1000BASE-LX Gigabit Ethernet Fiber SFP

Release date: 2021-03-15 Date of issue: 2021-03-15 Filename: 70114055_eng.pdf

Refer to "General Notes Relating to Pepperl+Fuchs Product Information".

Pepperl+Fuchs Group
www.pepperl-fuchs.comUSA: +1 330 486 0001
fa-info@us.pepperl-fuchs.comGermany: +49 621 776 1111
fa-info@de.pepperl-fuchs.comSingapore: +65 6779 9091
fa-info@sg.pepperl-fuchs.com PEPPERL+FUCHS

Accessories

	SFP-S-30KM-F-N	Single-mode 30KM 100BASE-LX Fast Ethernet Fiber SFP
	SFP-S-30KM-F-W	Single-mode 30KM 100BASE-LX Fast Ethernet Fiber SFP
	SFP-S-30KM-G-W	Single-mode 30KM 1000BASE-LX Gigabit Ethernet Fiber SFP
	SFP-S-40KM-G-W	Single-mode 40KM 1000BASE-EX Gigabit Ethernet Fiber SFP
	SFP-S-50KM-G-W	Single-mode 50KM 1000BASE-XD Gigabit Ethernet Fiber SFP
	SFP-S-60KM-F-W	Single-mode 60KM 100BASE-ZX Fast Ethernet Fiber SFP
	SFP-S-70KM-G-W	Single-mode 70KM 1000BASE-LX Gigabit Ethernet Fiber SFP
	SFP-S-90KM-G-W	Single-mode 90KM 1000BASE-ZX Gigabit Ethernet Fiber SFP