

BB-2J7B83BC-150

4× 5GNR MIMOScrew Mount

Key Features

Cable 1 - 4: 5GNR

- 617-960 MHz
- 1427-2690 MHz
- 3300-5000 MHz
- 5150-5925 MHz

Screw Mount

Heavy Duty antenna

High Performance

Ground Plane Independent

Anti-Rotation Mounting

Dimensions: Ø 96 x H 130 mm

Certificates: IP67, IP69, IK09



1. Antenna and electrical specifications

Cable 1	
Parameters	5GNR Antenna
Technologies	5G, 4G, 3G and 2G
Standards	5GNR/4GLTE/FirstNet/CBRS/LPWA/CAT-X/CAT-Mx/CAT-NBx/NB-IoT/3G/2G
Frequency (MHz)	617-960 1427-2690 3300-5000 5150-5925
Band (MHz)	600, 700, 850, 900 1500, 1600, 1700, 1800, 1900, 2000, 2100, 2300, 2500, 2600 3300, 3500, 3600, 3700, 4500 5200, 5500, 5800
5GNR Bands	n5, n8, n12, n20, n28, n71, n81, n82, n83, n1, n2, n3, n7, n25, n34, n38, n39, n40, n41, n50, n51, n66, n70, n74, n75, n76, n80, n84, n86 n77, n78, n79
4GLTE Bands	B5, B6, B8, B12, B13, B14, B17, B18, B19, B20, B26, B27, B28, B29, B44, B67, B68, B71, B85 B1, B2, B3, B4, B7, B9, B10, B11, B21, B23, B24, B25, B30, B32, B33, B34, B35, B36, B37, B38, B39, B40, B41, B45, B50, B51, B65, B66, B69, B70, B74, B75, B76 B22, B42, B43, B48, B49, B52 B46, B47, B252, B255
3GCELL Bands	B5, B6, B8, B12, B13, B14, B19, B20, B26 B1, B2, B3, B4, B7, B9, B10, B11, B21, B25, B32, B33, B34, B35, B36, B37, B38, B39, B40 B22
2GCELL Bands	710, 750, 810T, 850, 900P, 900E, 900R 1800DCS, 1900PCS
CDMACELL Bands	BC0, BC2, BC3, BC7, BC9, BC10, BC12, BC18, BC19 BC1, BC4, BC6, BC8, BC13, BC14, BC15, BC16, BC20, BC21
Return Loss (dB)	~-5.6 ~-11.7 ~-15.2 ~-14.2
VSWR	~3.5:1 ~1.9:1 ~1.5:1 ~1.6:1
Efficiency (%)	~32.0 ~41.4 ~41.7 ~36.9
Peak Gain (dBi)	~1.3 ~3.4 ~4.8 ~4.0
Average Gain (dB)	~-5.0 ~-3.9 ~-3.8 ~-4.4
Impedance (Ohm)	50
Polarisation	Linear
Radiation Pattern	Omni-Directional
Max. Input Power (W)	35
Connector Type	SMA-Male
Cable Length	150 cm
Cable Type	LL195

Cable 2

Parameters	5G NR Antenna			
	5G, 4G, 3G and 2G			
	5G NR/4GLTE/FirstNet/CBRS/LPWA/CAT-X/CAT-Mx/CAT-NBx/NB-IoT/3G/2G			
Technologies				
Standards				
Frequency (MHz)	617-960	1427-2690	3300-5000	5150-5925
Band (MHz)	600, 700, 850, 900	1500, 1600, 1700, 1800, 1900, 2000, 2100, 2300, 2500, 2600	3300, 3500, 3600, 3700, 4500	5200, 5500, 5800
5G NR Bands	n5, n8, n12, n20, n28, n71, n81, n82, n83,	n1, n2, n3, n7, n25, n34, n38, n39, n40, n41, n50, n51, n66, n70, n74, n75, n76, n80, n84, n86	n77, n78, n79	
4GLTE Bands	B5, B6, B8, B12, B13, B14, B17, B18, B19, B20, B26, B27, B28, B29, B44, B67, B68, B71, B85	B1, B2, B3, B4, B7, B9, B10, B11, B21, B23, B24, B25, B30, B32, B33, B34, B35, B36, B37, B38, B39, B40, B41, B45, B50, B51, B65, B66, B69, B70, B74, B75, B76	B22, B42, B43, B48, B49, B52	B46, B47, B252, B255
3GCELL Bands	B5, B6, B8, B12, B13, B14, B19, B20, B26	B1, B2, B3, B4, B7, B9, B10, B11, B21, B25, B32, B33, B34, B35, B36, B37, B38, B39, B40	B22	
2GCELL Bands	710, 750, 810T, 850, 900P, 900E, 900R	1800DCS, 1900PCS		
CDMACELL Bands	BC0, BC2, BC3, BC7, BC9, BC10, BC12, BC18, BC19	BC1, BC4, BC6, BC8, BC13, BC14, BC15, BC16, BC20, BC21		
Return Loss (dB)	~-6.2	~-12.5	~-15.1	~-16.0
VSWR	~3.2:1	~1.9:1	~1.5:1	~1.5:1
Efficiency (%)	~31.8	~41.1	~42.8	~33.1
Peak Gain (dBi)	~1.2	~3.5	~4.6	~3.2
Average Gain (dB)	~-5.0	~-3.9	~-3.7	~-4.8
Impedance (Ohm)	50			
Polarisation	Linear			
Radiation Pattern	Omni-Directional			
Max. Input Power (W)	35			
Connector Type	SMA-Male			
Cable Length	150 cm			
Cable Type	LL195			

Cable 3

Parameters	5G NR Antenna			
	5G, 4G, 3G and 2G			
	5G NR/4GLTE/FirstNet/CBRS/LPWA/CAT-X/CAT-Mx/CAT-NBx/NB-IoT/3G/2G			
Technologies				
Standards				
Frequency (MHz)	617-960	1427-2690	3300-5000	5150-5925
Band (MHz)	600, 700, 850, 900	1500, 1600, 1700, 1800, 1900, 2000, 2100, 2300, 2500, 2600	3300, 3500, 3600, 3700, 4500	5200, 5500, 5800
5G NR Bands	n5, n8, n12, n20, n28, n71, n81, n82, n83,	n1, n2, n3, n7, n25, n34, n38, n39, n40, n41, n50, n51, n66, n70, n74, n75, n76, n80, n84, n86	n77, n78, n79	
4GLTE Bands	B5, B6, B8, B12, B13, B14, B17, B18, B19, B20, B26, B27, B28, B29, B44, B67, B68, B71, B85	B1, B2, B3, B4, B7, B9, B10, B11, B21, B23, B24, B25, B30, B32, B33, B34, B35, B36, B37, B38, B39, B40, B41, B45, B50, B51, B65, B66, B69, B70, B74, B75, B76	B22, B42, B43, B48, B49, B52	B46, B47, B252, B255
3GCELL Bands	B5, B6, B8, B12, B13, B14, B19, B20, B26	B1, B2, B3, B4, B7, B9, B10, B11, B21, B25, B32, B33, B34, B35, B36, B37, B38, B39, B40	B22	
2GCELL Bands	710, 750, 810T, 850, 900P, 900E, 900R	1800DCS, 1900PCS		
CDMACELL Bands	BC0, BC2, BC3, BC7, BC9, BC10, BC12, BC18, BC19	BC1, BC4, BC6, BC8, BC13, BC14, BC15, BC16, BC20, BC21		
Return Loss (dB)	~-5.6	~-12.8	~-16.7	~-12.4
VSWR	~3.7:1	~1.8:1	~1.4:1	~1.8:1
Efficiency (%)	~31.7	~41.7	~40.3	~38.5
Peak Gain (dBi)	~1.3	~3.8	~4.5	~4.6
Average Gain (dB)	~-5.0	~-3.8	~-4.0	~-4.2
Impedance (Ohm)	50			
Polarisation	Linear			
Radiation Pattern	Omni-Directional			
Max. Input Power (W)	35			
Connector Type	SMA-Male			
Cable Length	150 cm			
Cable Type	LL195			

Cable 4

Parameters	5GNR Antenna			
Technologies	5G, 4G, 3G and 2G			
Standards	5GNR/4GLTE/FirstNet/CBRS/LPWA/CAT-X/CAT-Mx/CAT-NBx/NB-IoT/3G/2G			
Frequency (MHz)	617-960	1427-2690	3300-5000	5150-5925
Band (MHz)	600, 700, 850, 900	1500, 1600, 1700, 1800, 1900, 2000, 2100, 2300, 2500, 2600	3300, 3500, 3600, 3700, 4500	5200, 5500, 5800
5GNR Bands	n5, n8 ,12, n20, n28, n71, n81, n82, n83,	n1, n2, n3, n7, n25, n34, n38, n39, n40, n41, n50, n51, n66, n70, n74, n75, n76, n80, n84, n86	n77, n78, n79	
4GLTE Bands	B5, B6, B8, B12, B13, B14, B17, B18, B19, B20, B26, B27, B28, B29, B44, B67, B68, B71, B85	B1, B2, B3, B4, B7, B9, B10, B11, B21, B23, B24, B25, B30, B32, B33, B34, B35, B36, B37, B38, B39, B40, B41, B45, B50, B51, B65, B66, B69, B70, B74, B75, B76	B22, B42, B43, B48, B49, B52	B46, B47, B252, B255
3GCELL Bands	B5, B6, B8, B12, B13, B14, B19, B20, B26	B1, B2, B3, B4, B7, B9, B10, B11, B21, B25, B32, B33, B34, B35, B36, B37, B38, B39, B40	B22	
2GCELL Bands	710, 750, 810T, 850, 900P, 900E, 900R	1800DCS, 1900PCS		
CDMACELL Bands	BC0, BC2, BC3, BC7, BC9, BC10, BC12, BC18, BC19	BC1, BC4, BC6, BC8, BC13, BC14, BC15, BC16, BC20, BC21		
Return Loss (dB)	~-5.9	~-12.7	~-16.8	~-15.4
VSWR	~3.3:1	~1.8:1	~1.5:1	~1.5:1
Efficiency (%)	~31.4	~41.8	~42.7	~35.0
Peak Gain (dBi)	~1.7	~3.4	~4.6	~3.9
Average Gain (dB)	~-5.1	~-3.8	~-3.7	~-4.6
Impedance (Ohm)	50			
Polarisation	Linear			
Radiation Pattern	Omni-Directional			
Max. Input Power (W)	35			
Connector Type	SMA-Male			
Cable Length	150 cm			
Cable Type	LL195			

Antenna Measurement Conditions:

Mounted on Metal Plate of 30 x 30 cm

200 cm of Cable LL195

Measured in Certified CTIA 3D Anechoic Chamber

2. Mechanical and environmental specifications

Specifications	2J7B83Bc
Mounting Type	Screw Mount
Dimensions (mm)	Ø 96 x H 130
Max. Tighten Torque (Nm)	6 Nm
Radome	ASA
Radome color	White, Black
Antenna Base	ASA
Operating Temperature (C)	-40 to +85
Storage Temperature (C)	-40 to +85
Substance Compliance	RoHS
Certificates	IP67, IP69, IK09

3. Antenna parameters

Cable 1: 5GNR

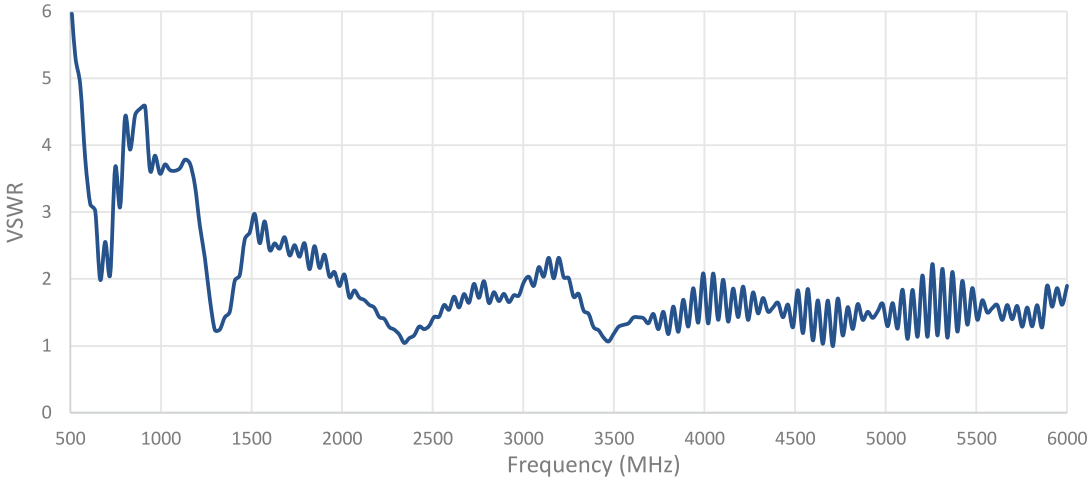
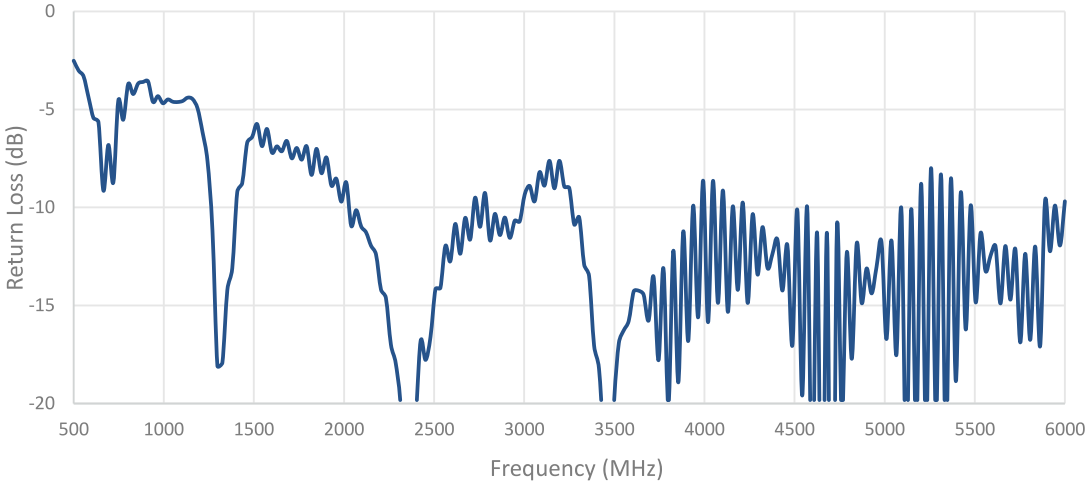

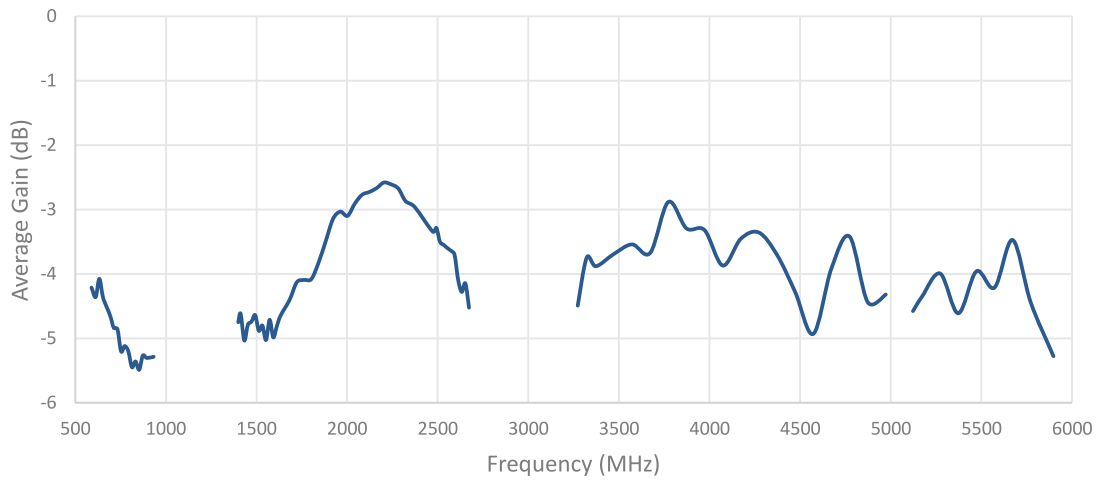
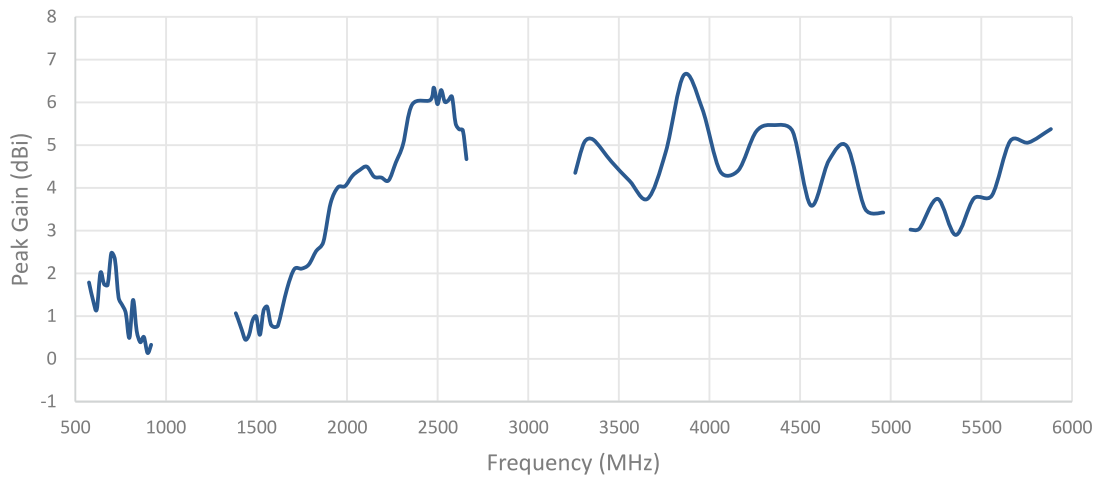
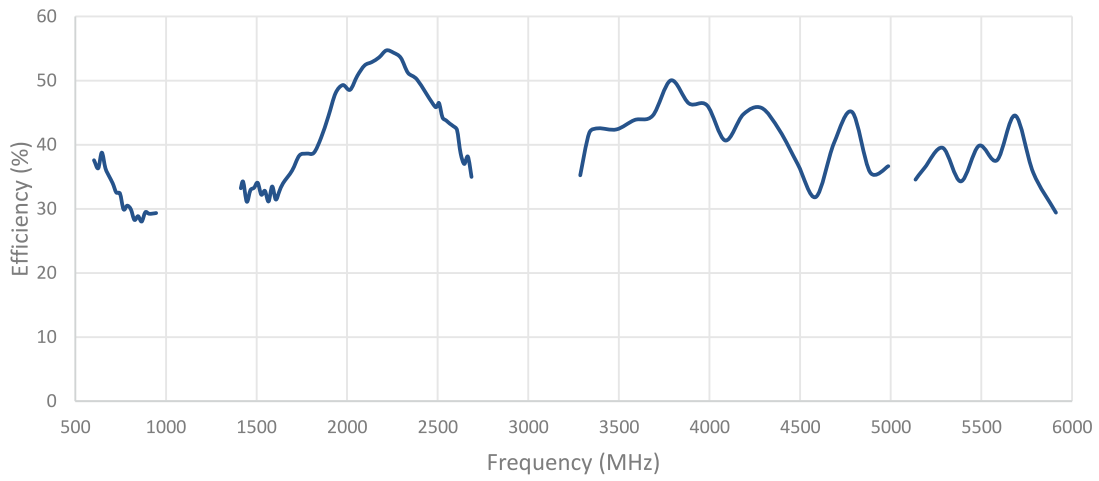

Cable 2: 5GNR

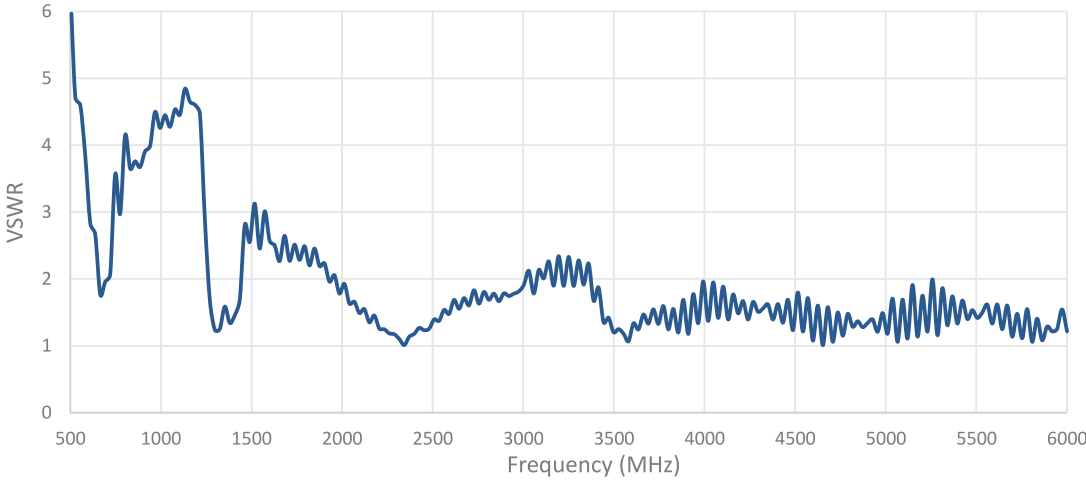
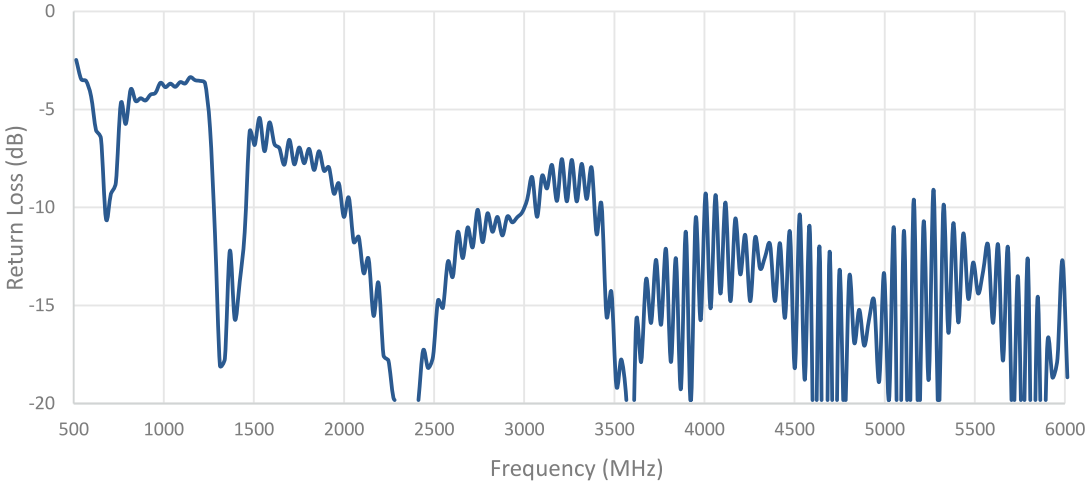

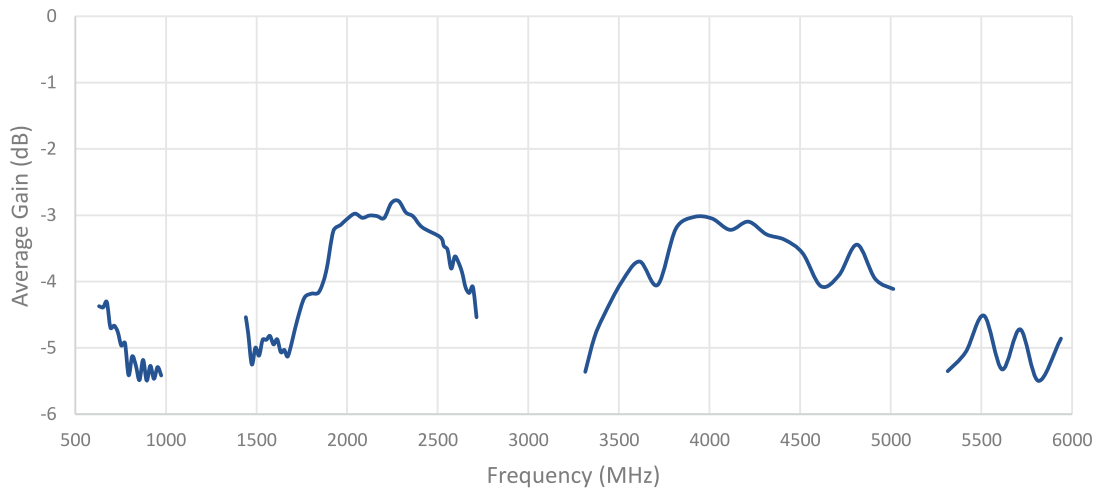
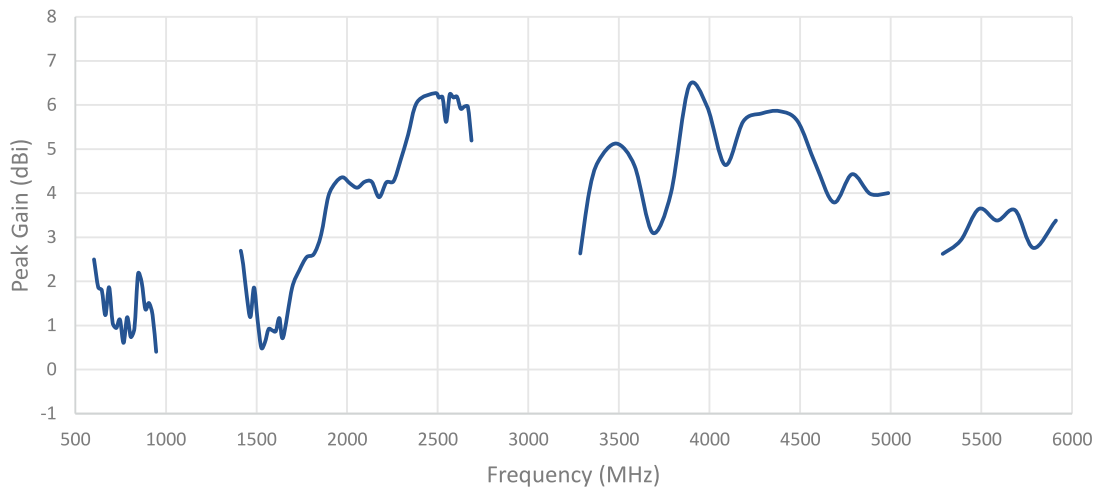
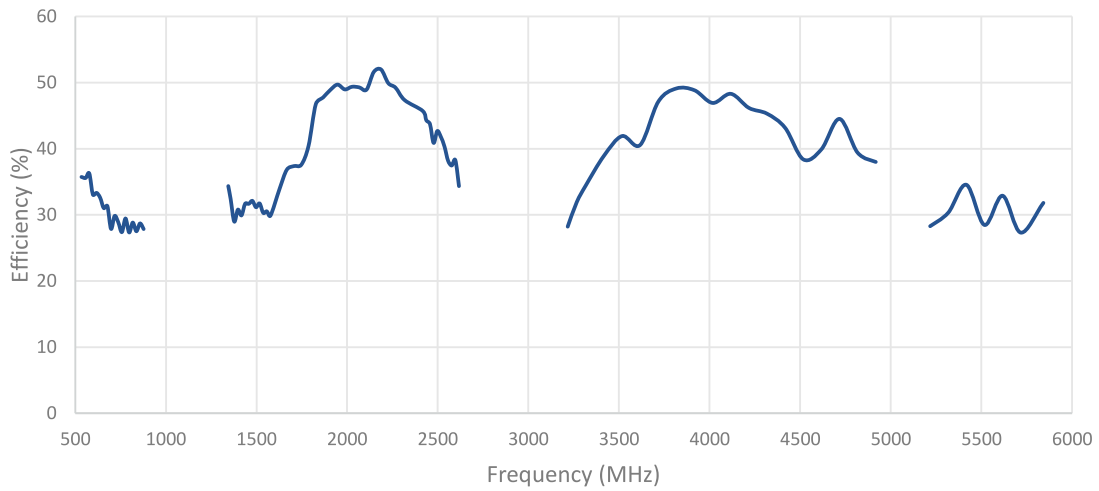

Cable 3: 5GNR

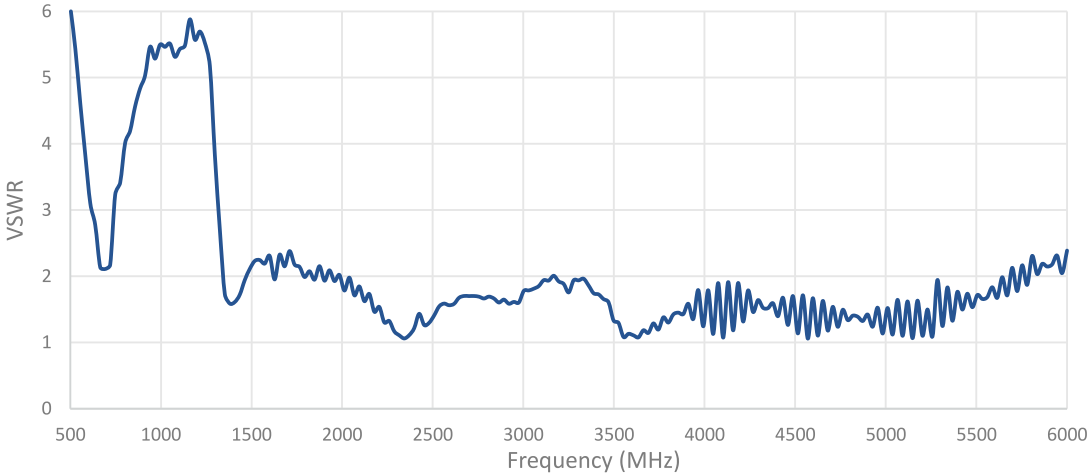
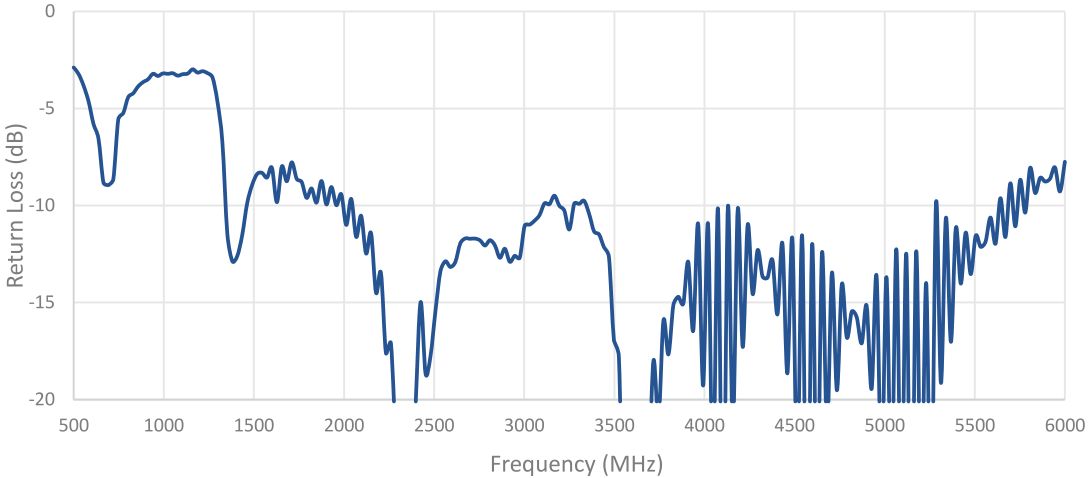

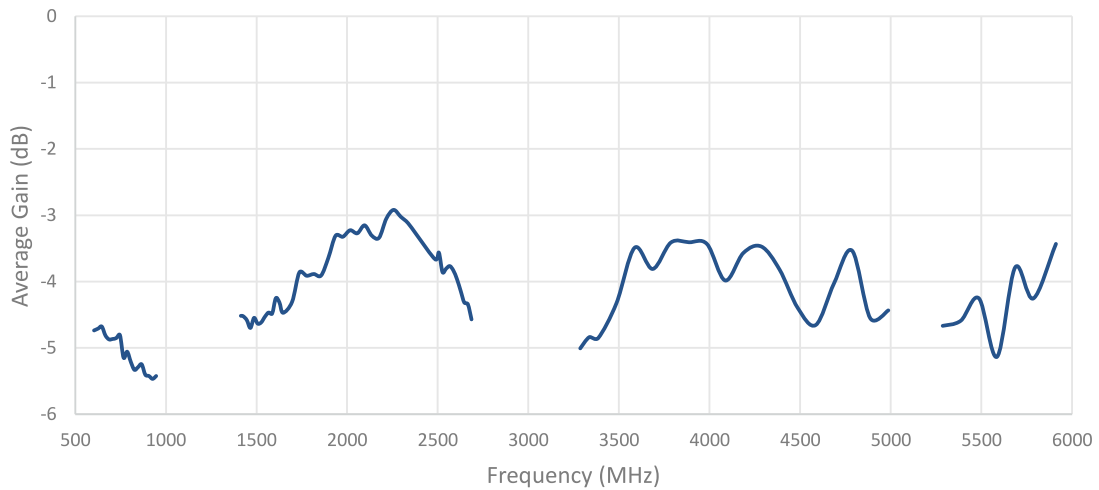
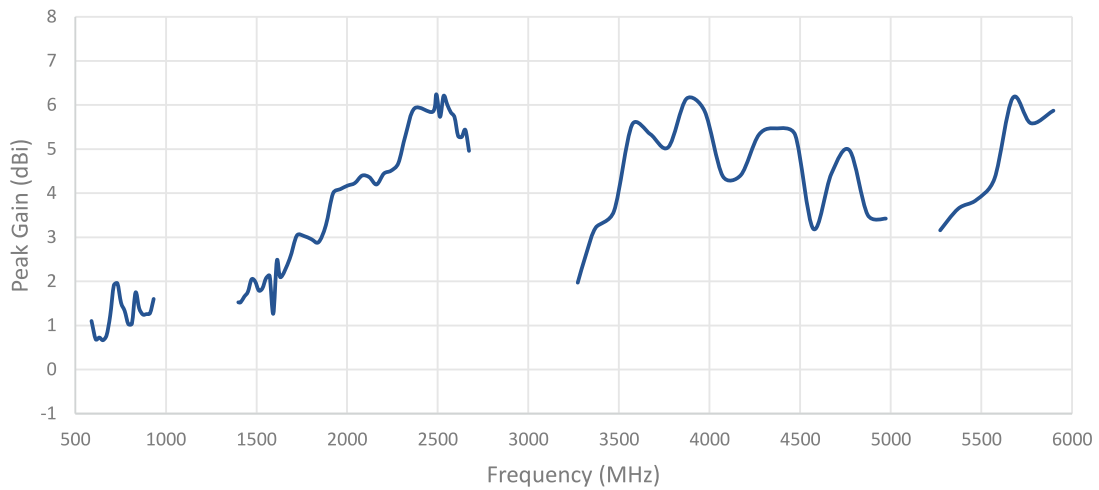
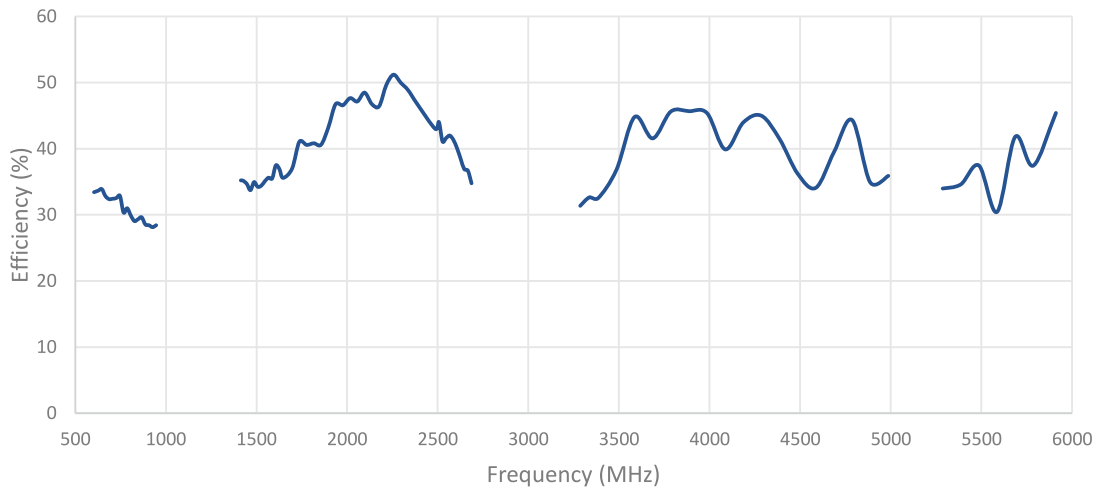

Cable 4: 5GNR

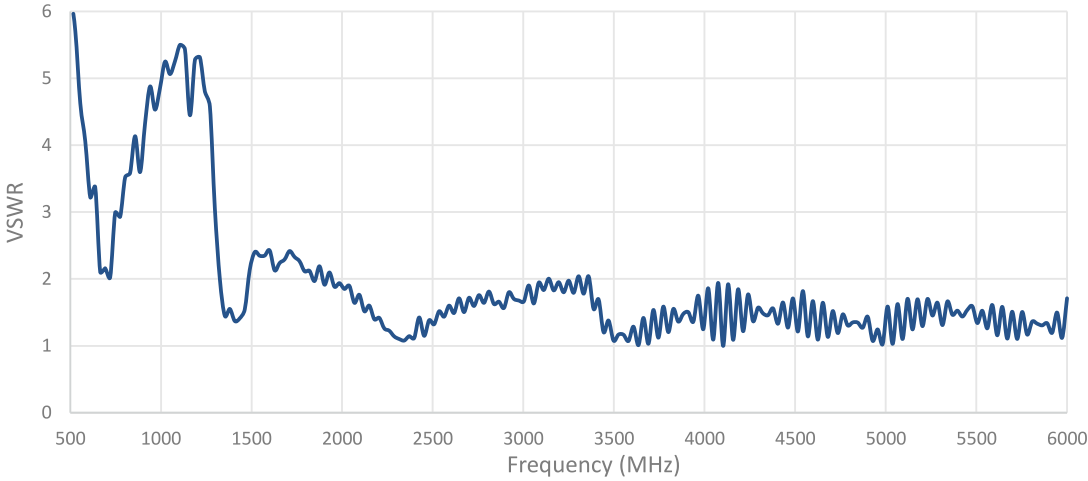
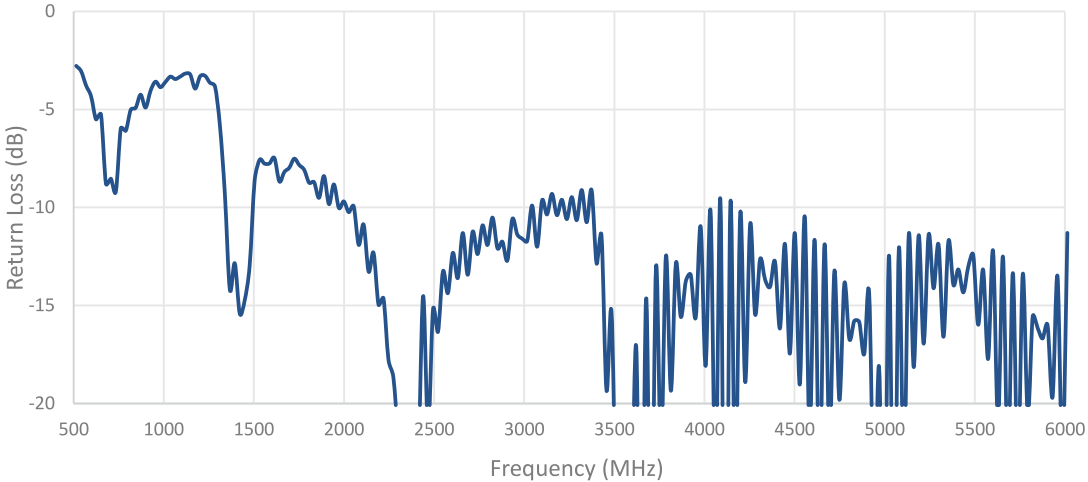

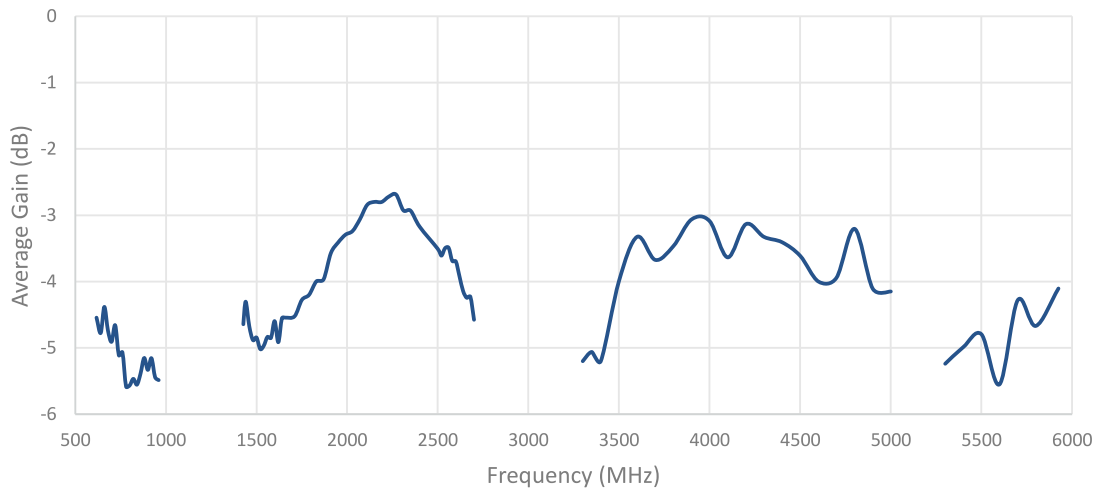
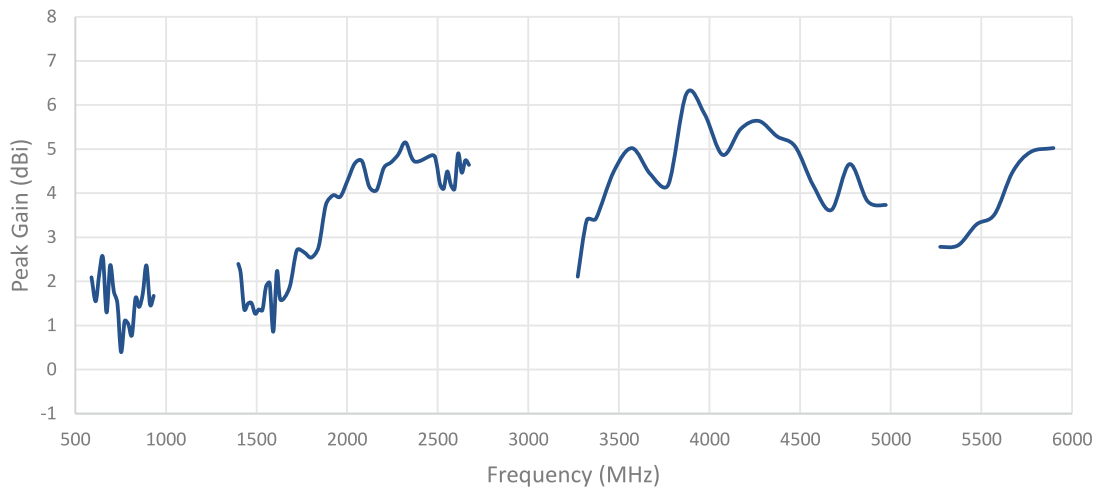
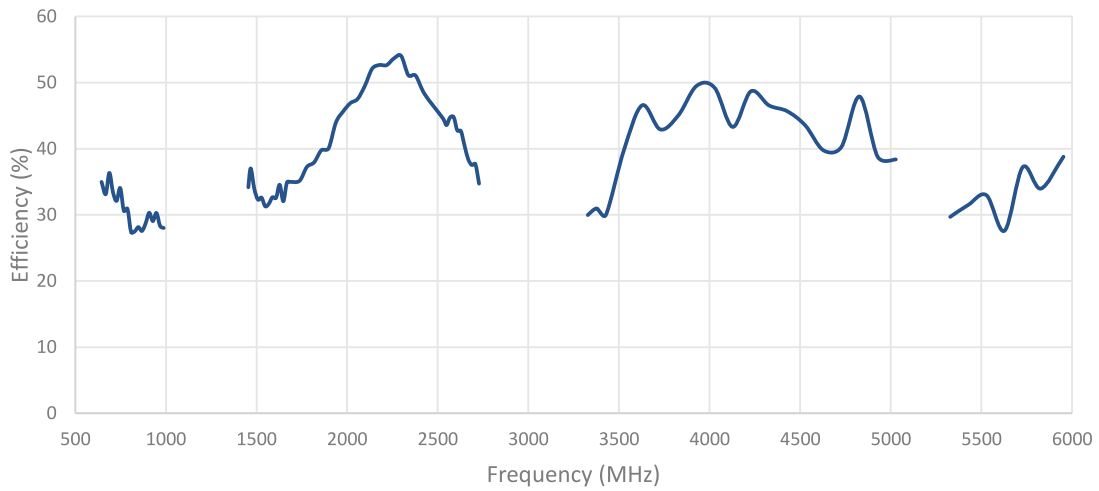

ISOLATION FOR CABLES 1 AND 2

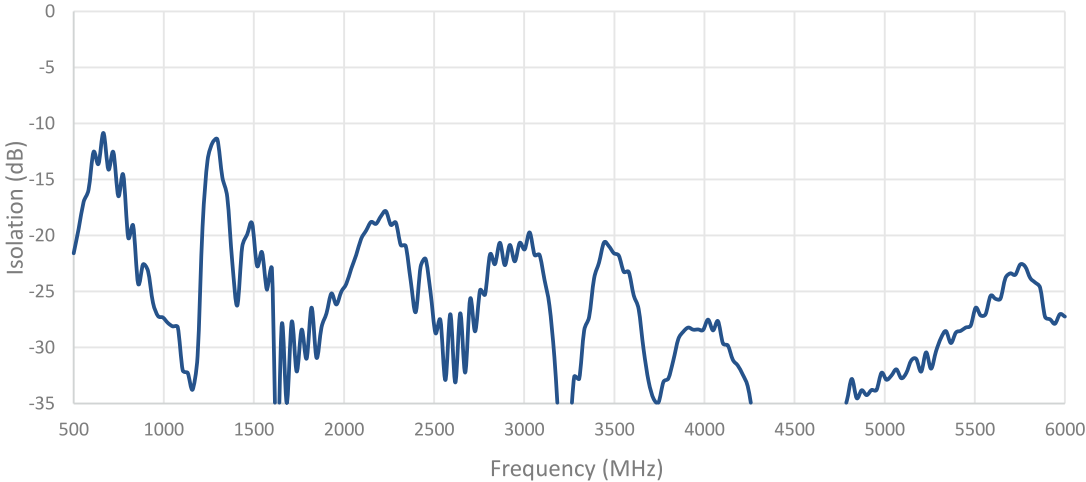

ISOLATION FOR CABLES 1 AND 3

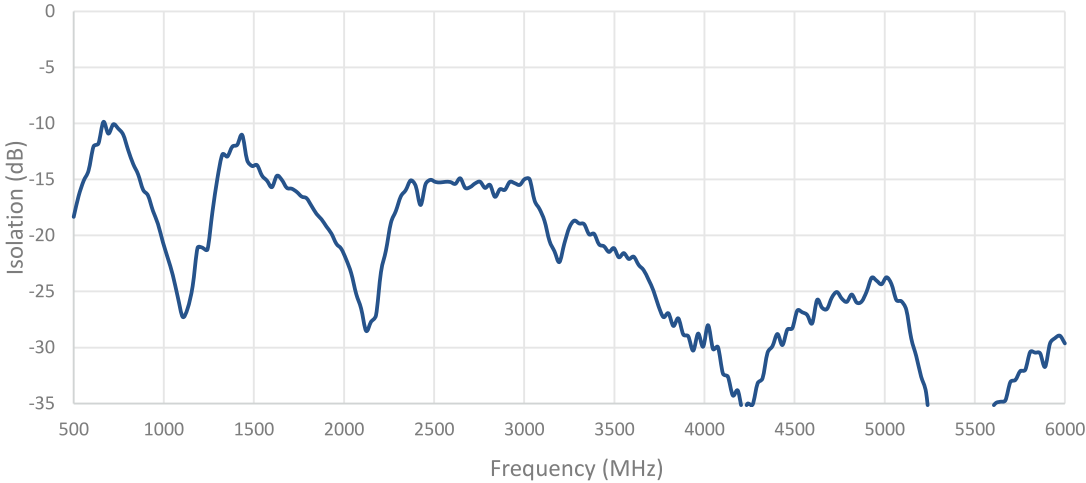

ISOLATION FOR CABLES 1 AND 4

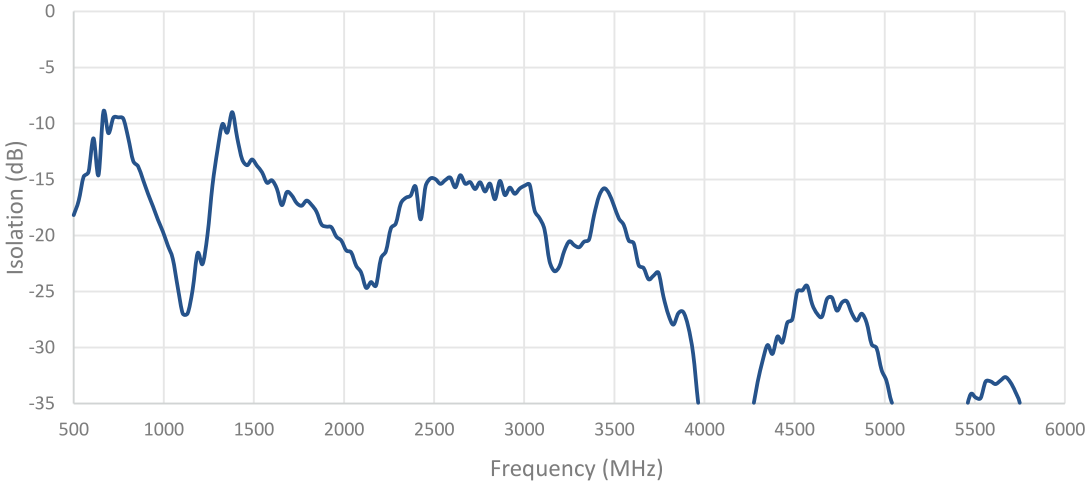

ISOLATION FOR CABLES 2 AND 3

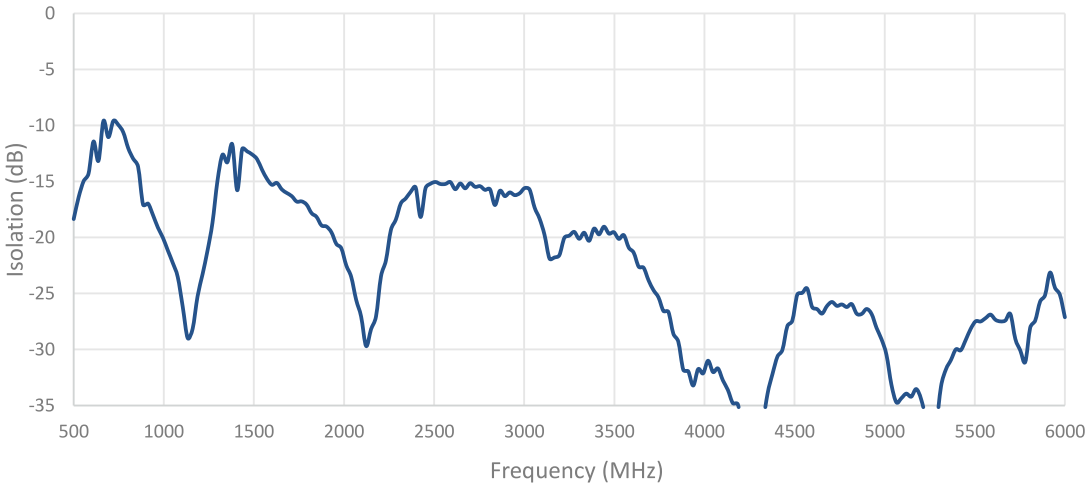

ISOLATION FOR CABLES 2 AND 4

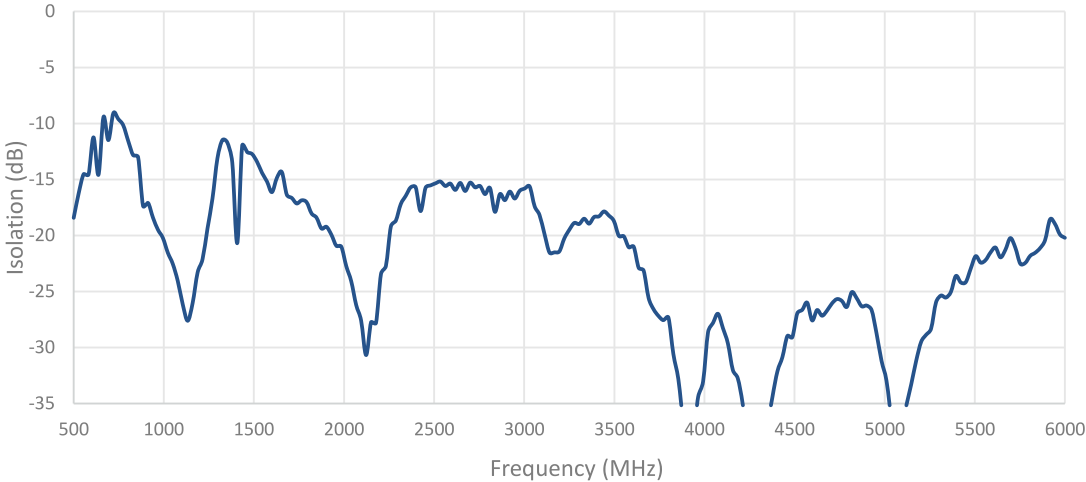

ISOLATION FOR CABLES 3 AND 4

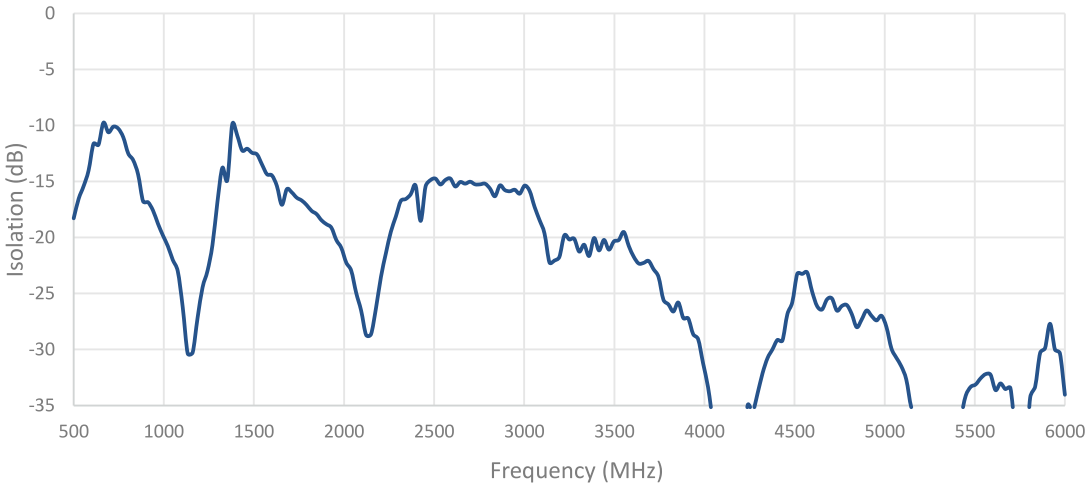

ENVELOPE CORRELATION COEFFICIENT FOR CABLES 1 AND 2

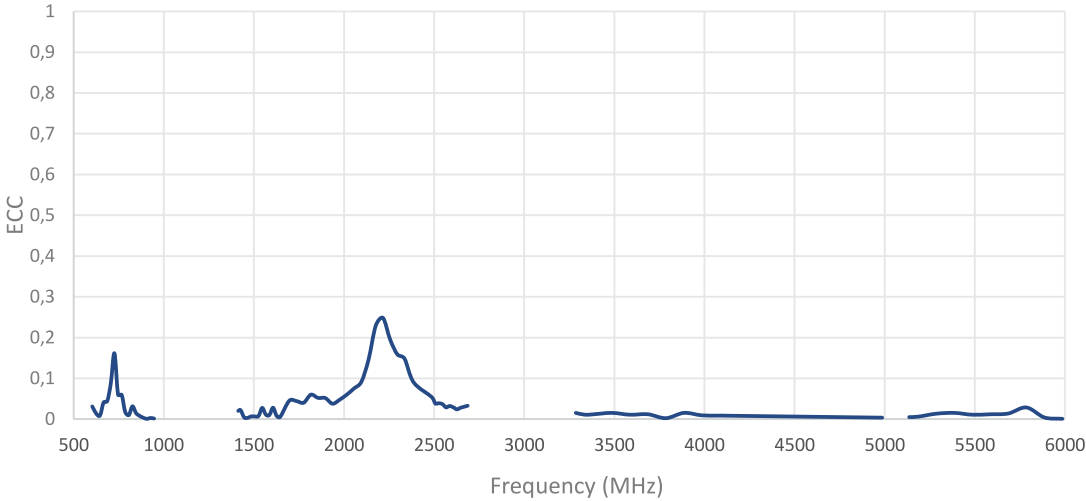

ENVELOPE CORRELATION COEFFICIENT FOR CABLES 1 AND 3

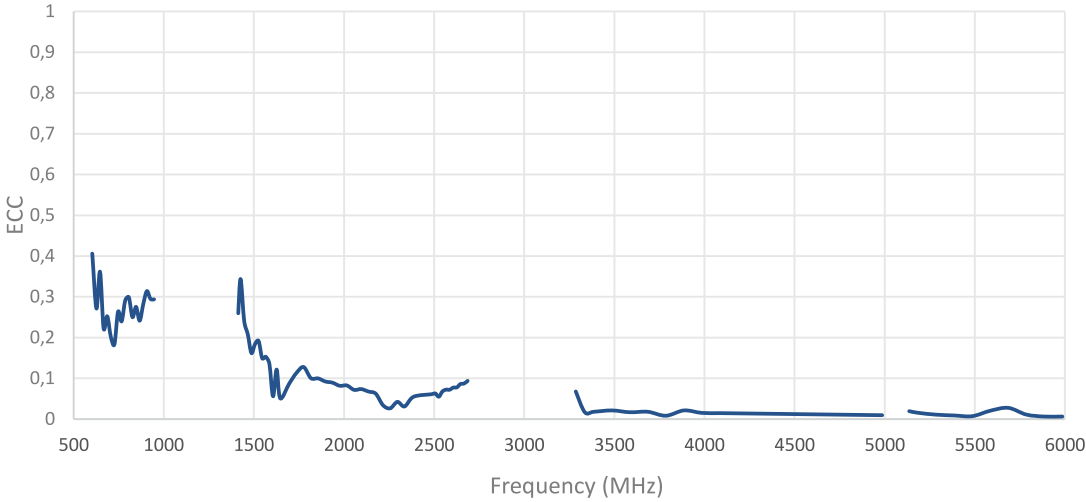

ENVELOPE CORRELATION COEFFICIENT FOR CABLES 1 AND 4

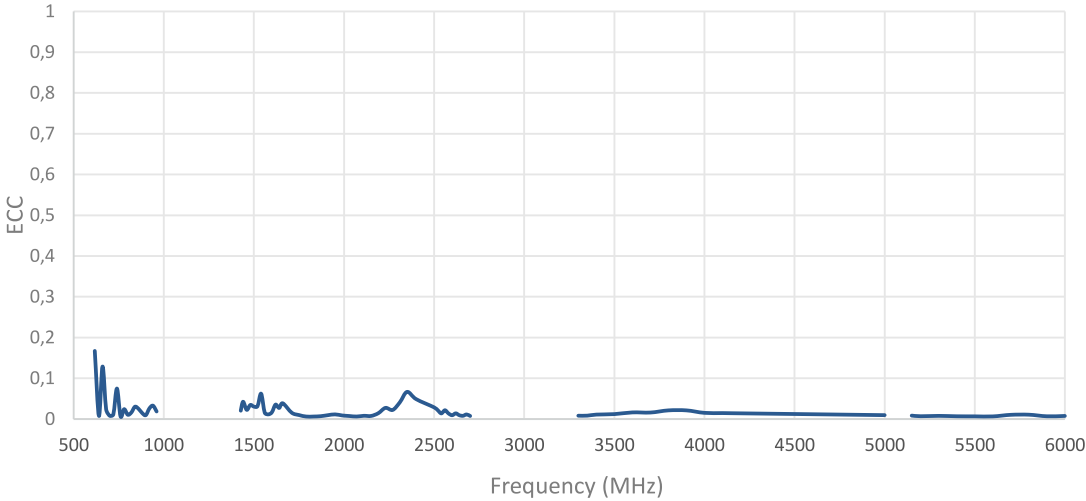

ENVELOPE CORRELATION COEFFICIENT FOR CABLES 2 AND 3

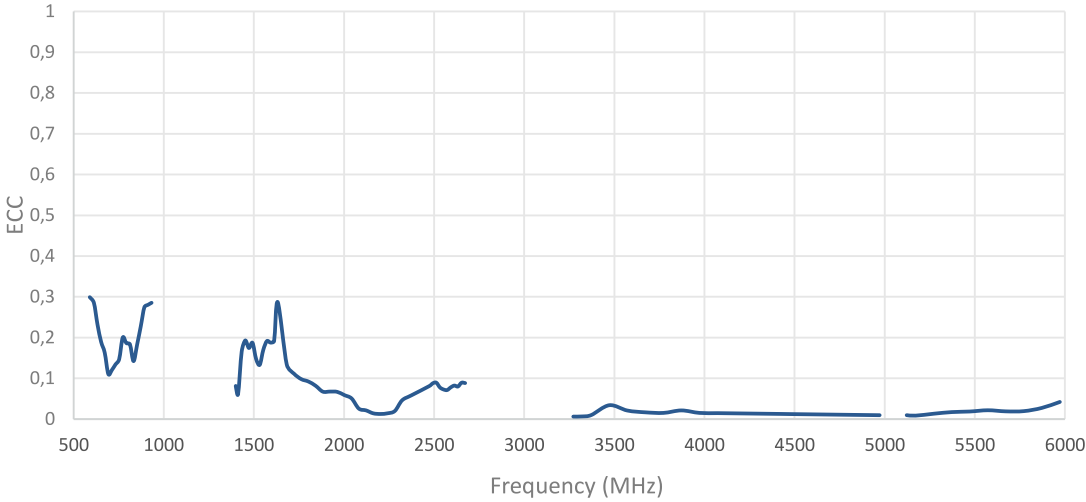

ENVELOPE CORRELATION COEFFICIENT FOR CABLES 2 AND 4

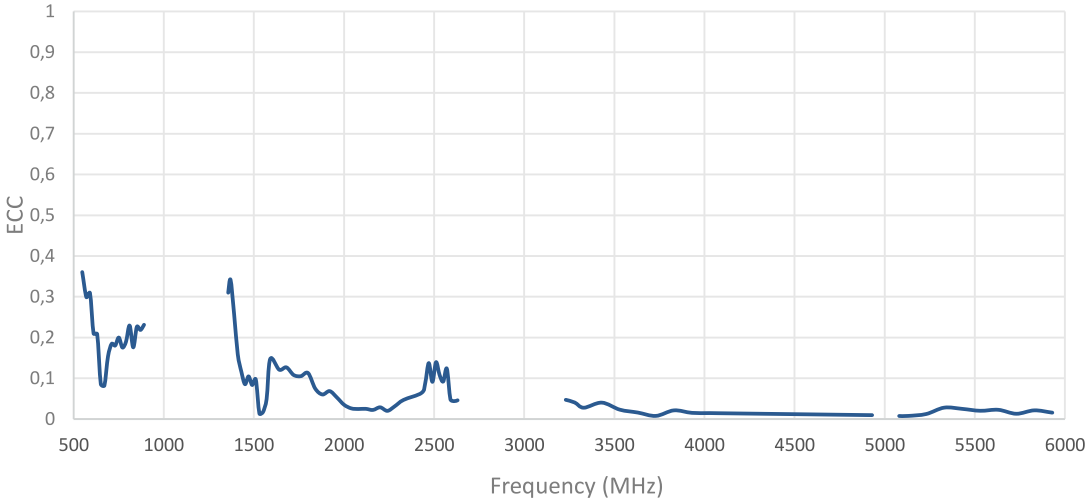

ENVELOPE CORRELATION COEFFICIENT FOR CABLES 3 AND 4

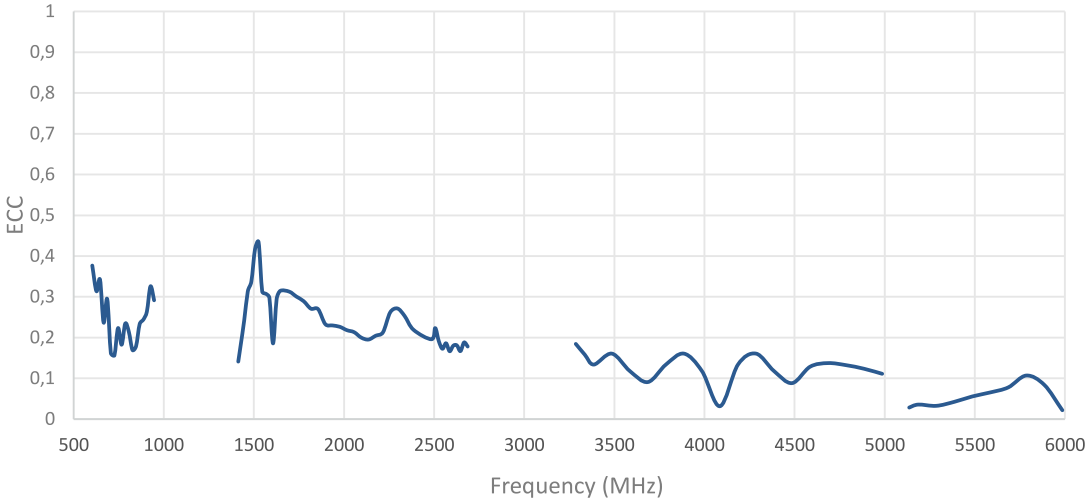



Radiation pattern reference

Cable 1: 5GNR

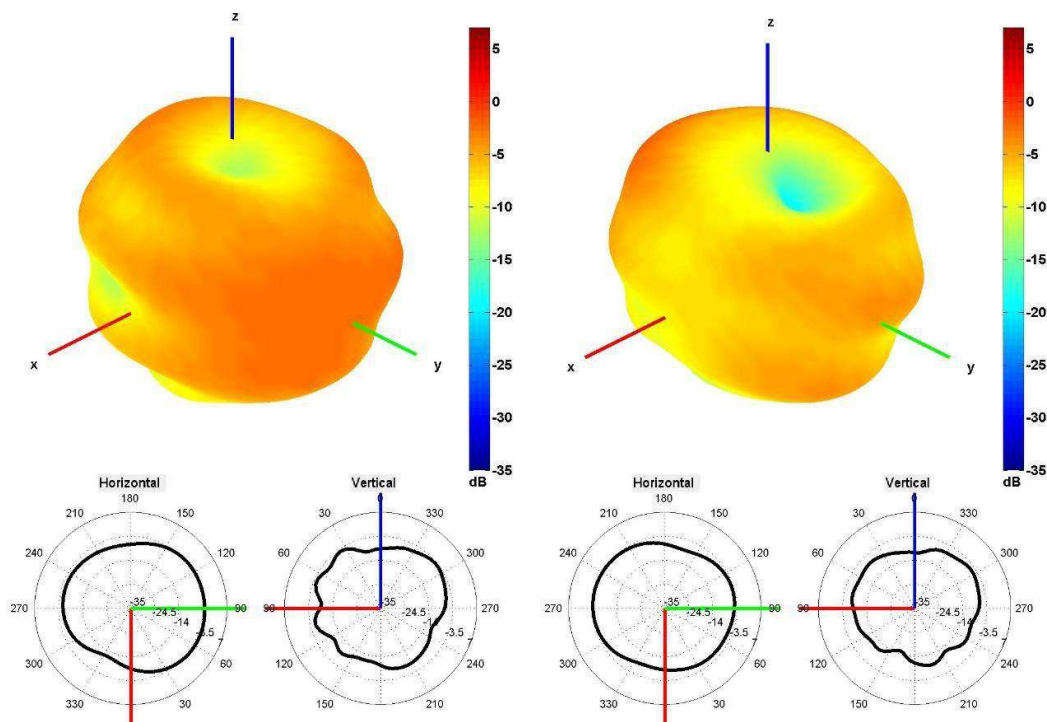

650 and 750 MHz Radiation pattern

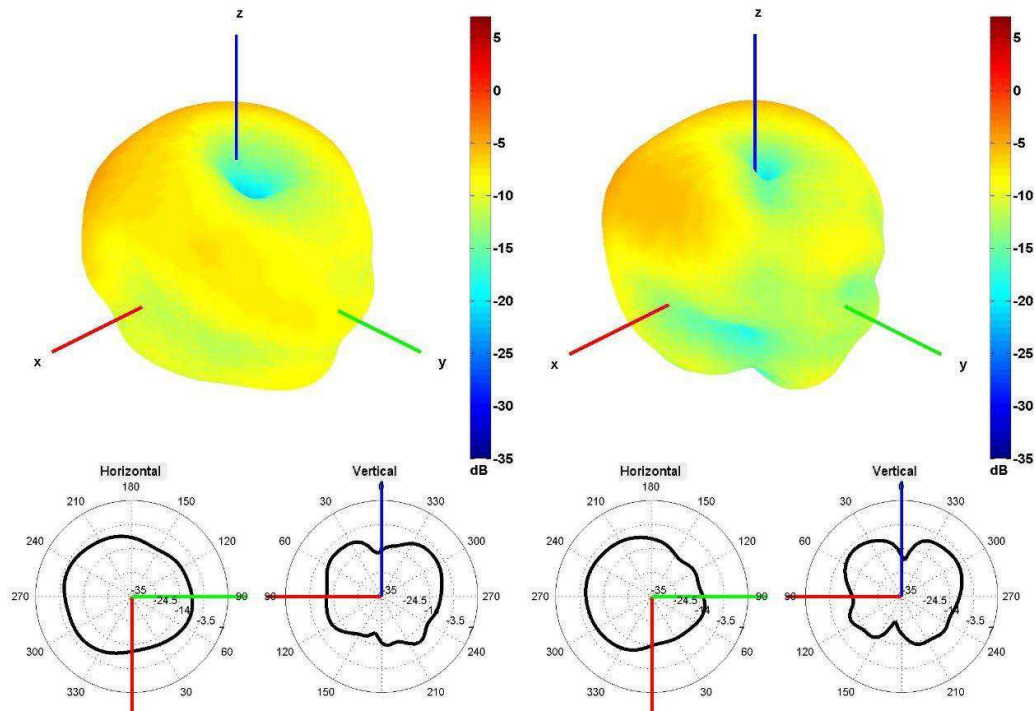

850 and 940 MHz Radiation pattern

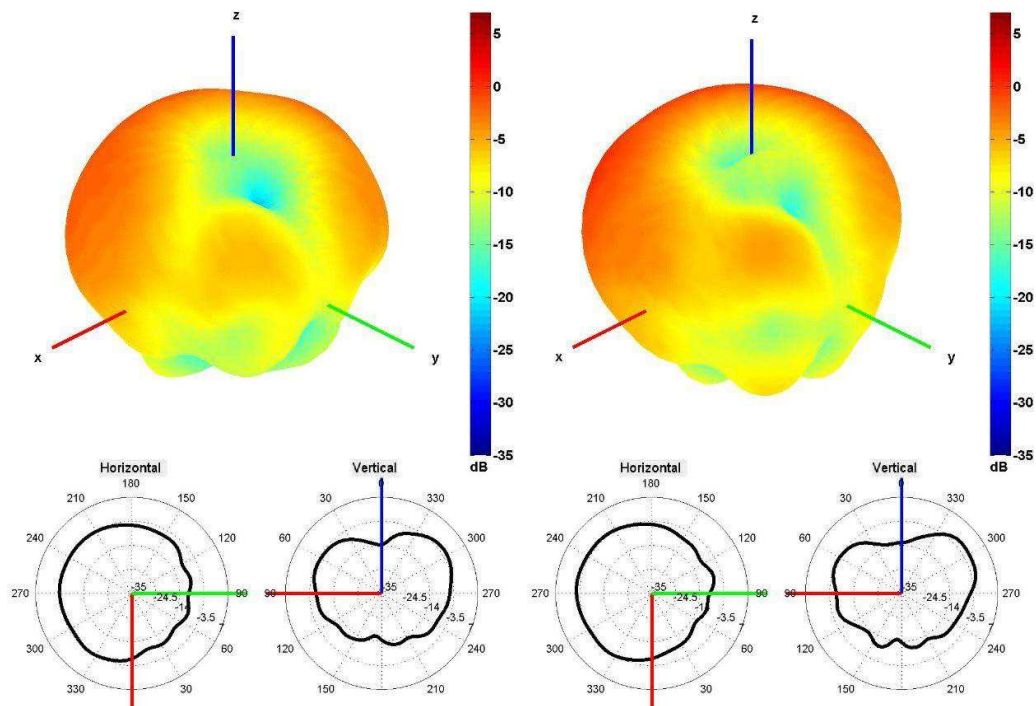

1500 and 1600 MHz Radiation pattern

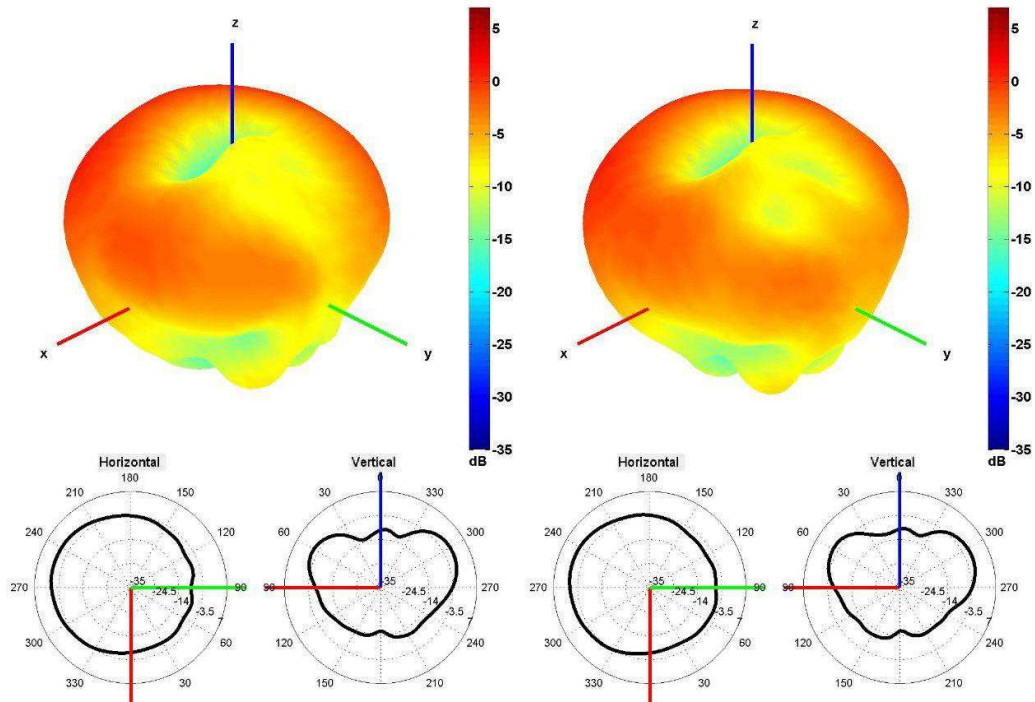

1750 and 1850 MHz Radiation pattern

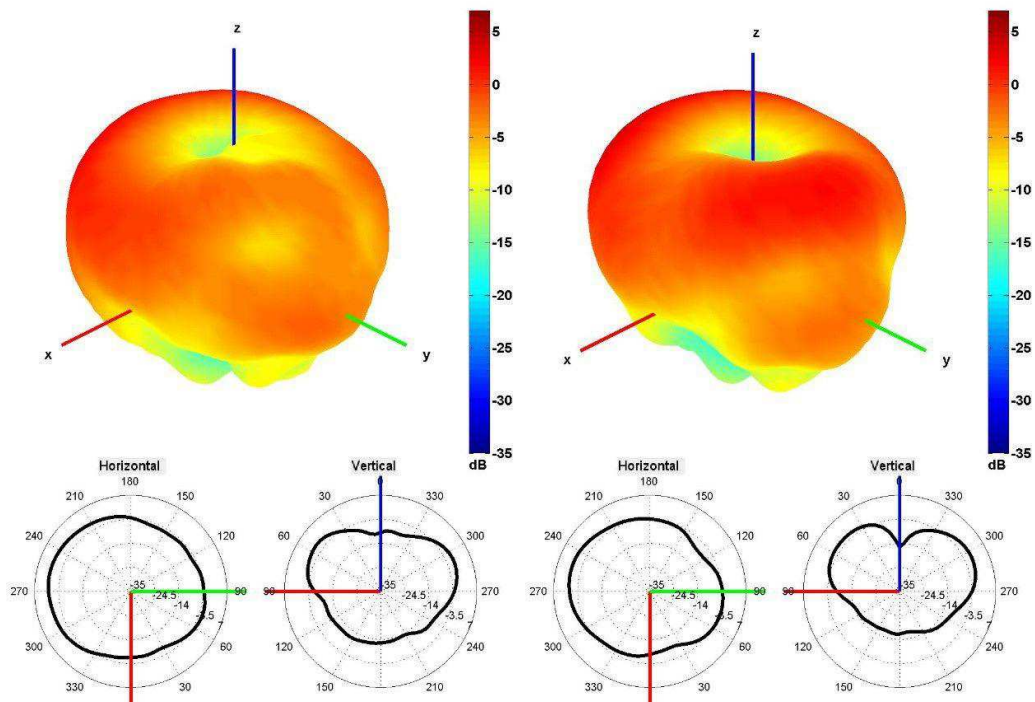

1950 and 2100 MHz Radiation pattern

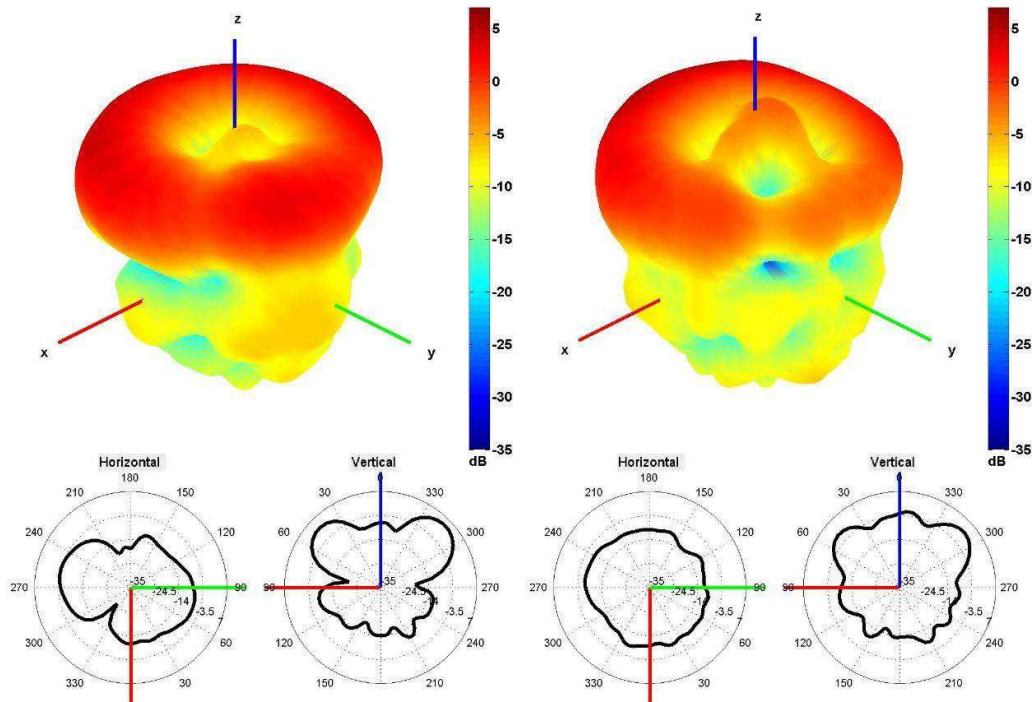

2350 and 2600 MHz Radiation pattern

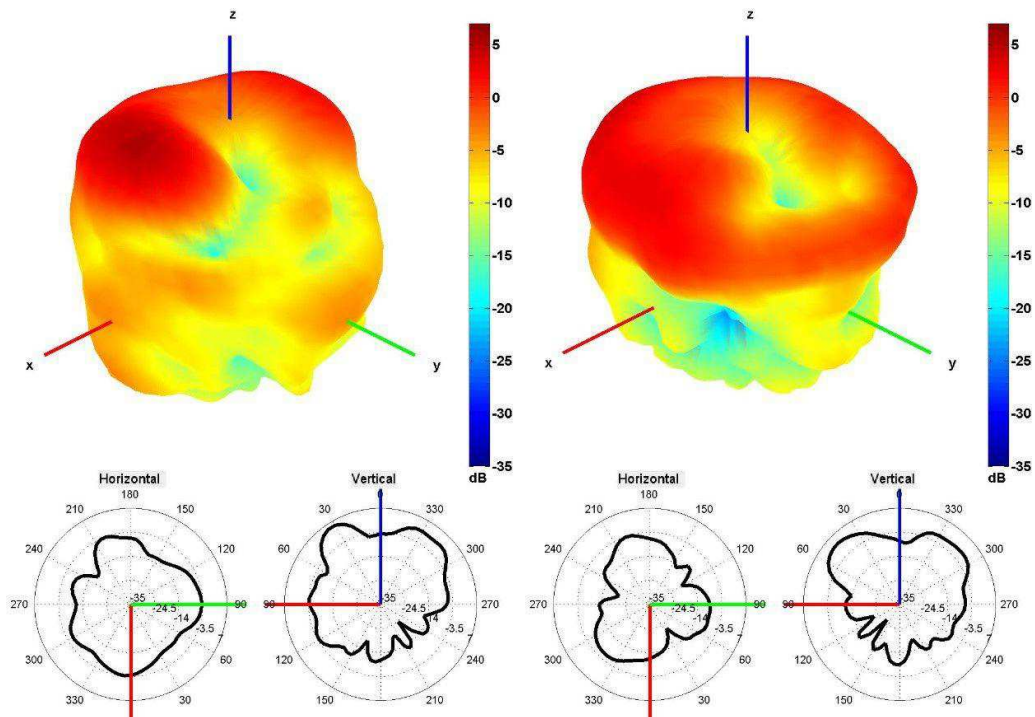

3350 and 3600 MHz Radiation pattern

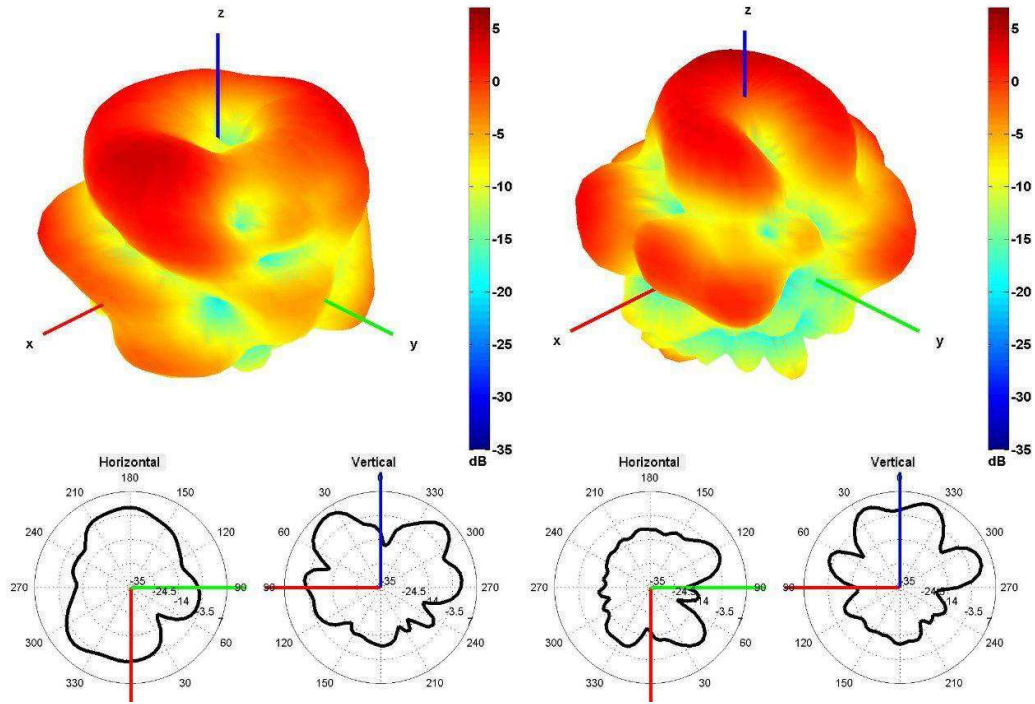

4500 and 5500 MHz Radiation pattern

Cable 2: 5GNR

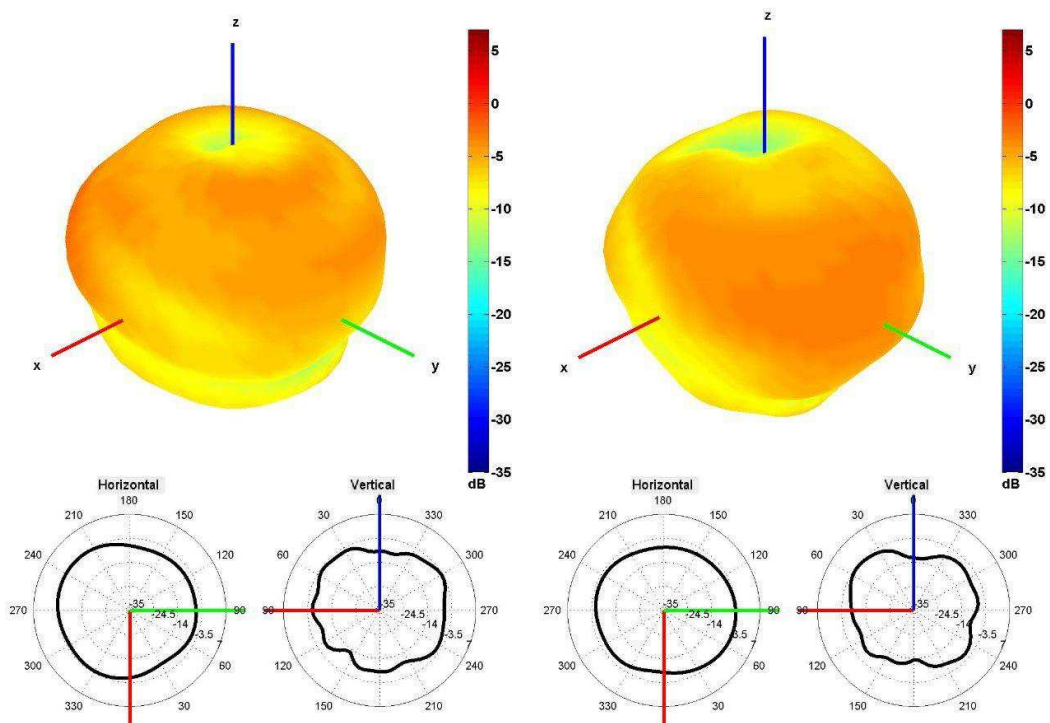

650 and 750 MHz Radiation pattern

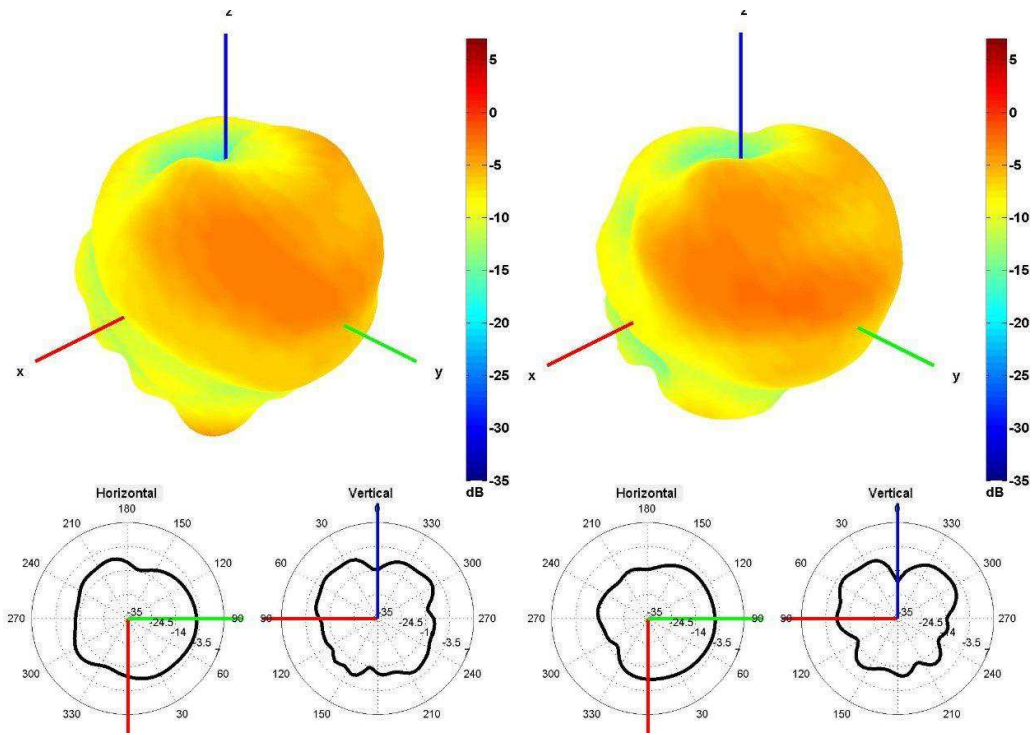

850 and 940 MHz Radiation pattern

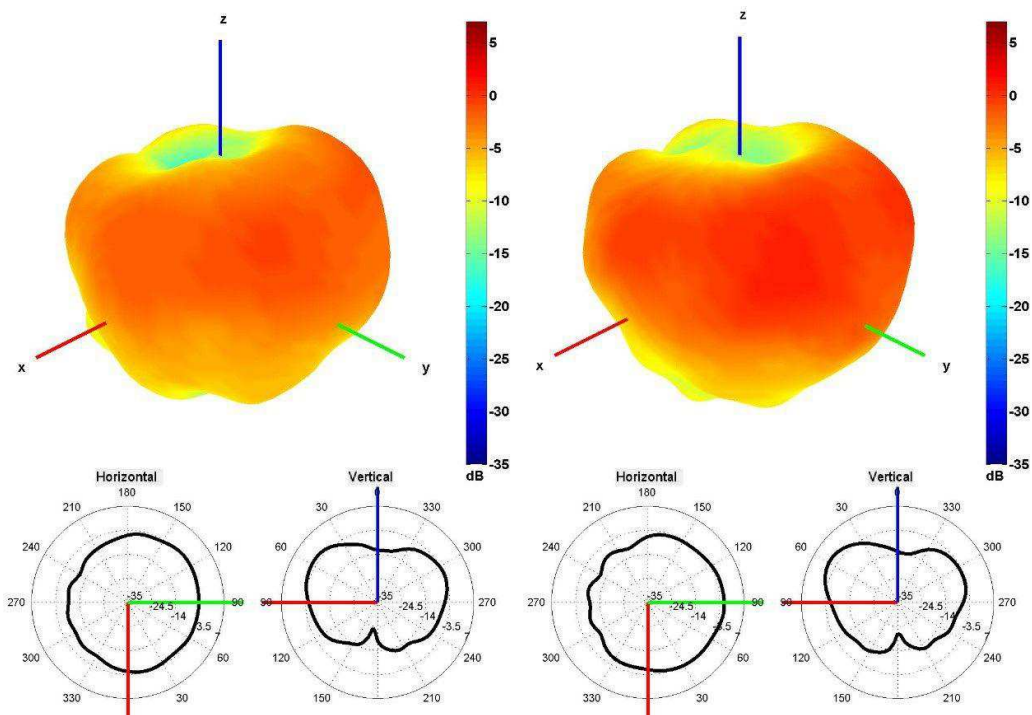

1500 and 1600 MHz Radiation pattern

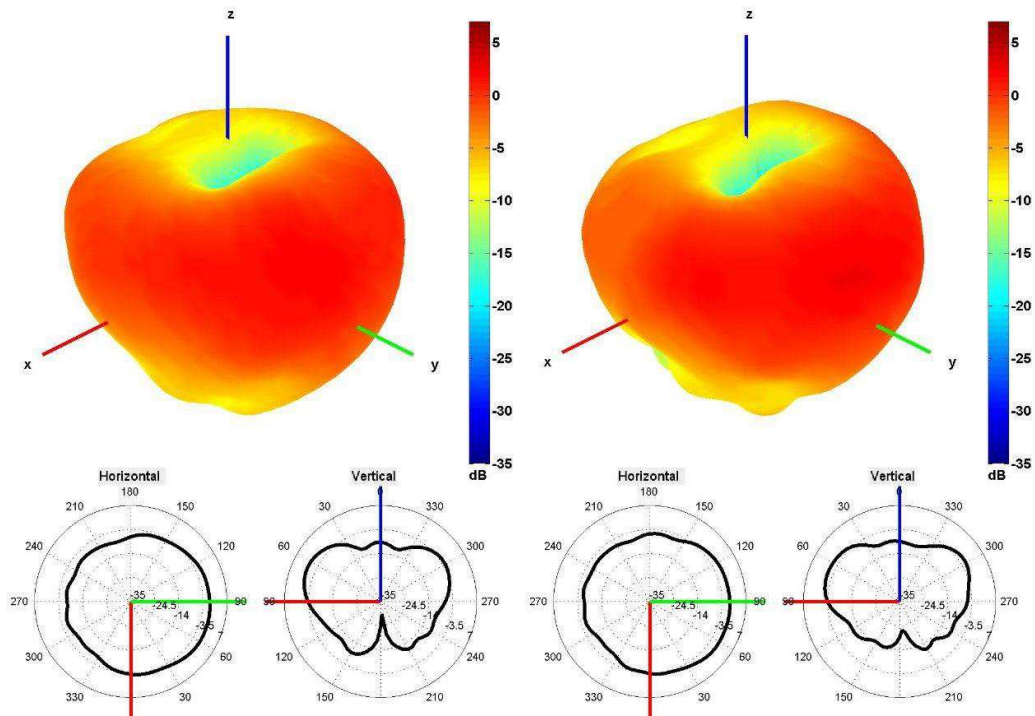

1750 and 1850 MHz Radiation pattern

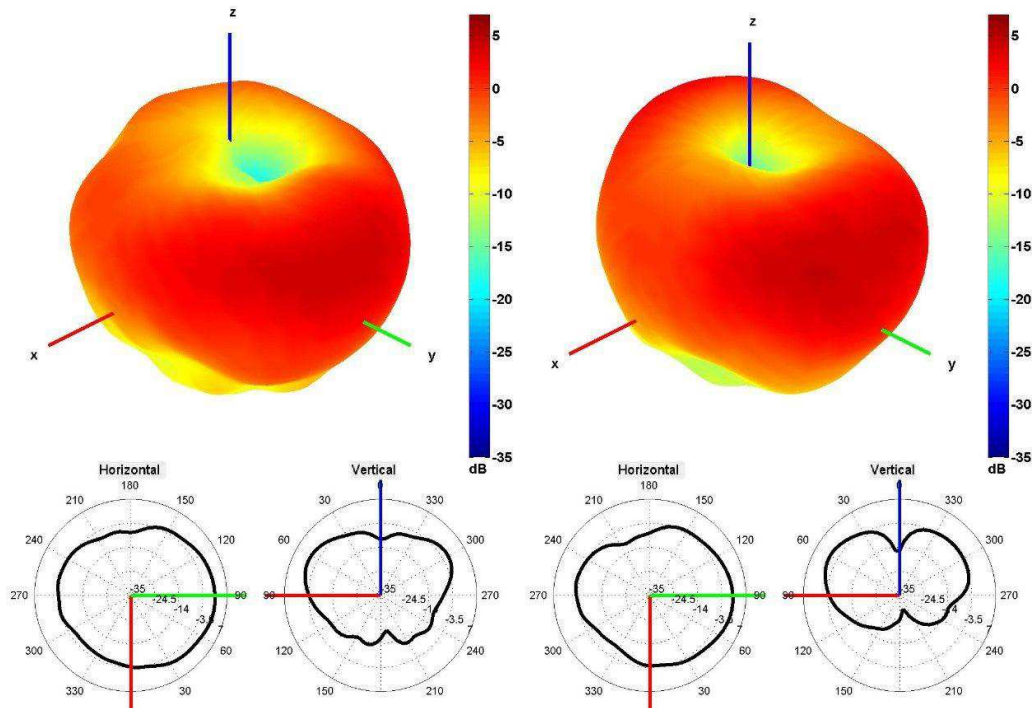

1950 and 2100 MHz Radiation pattern

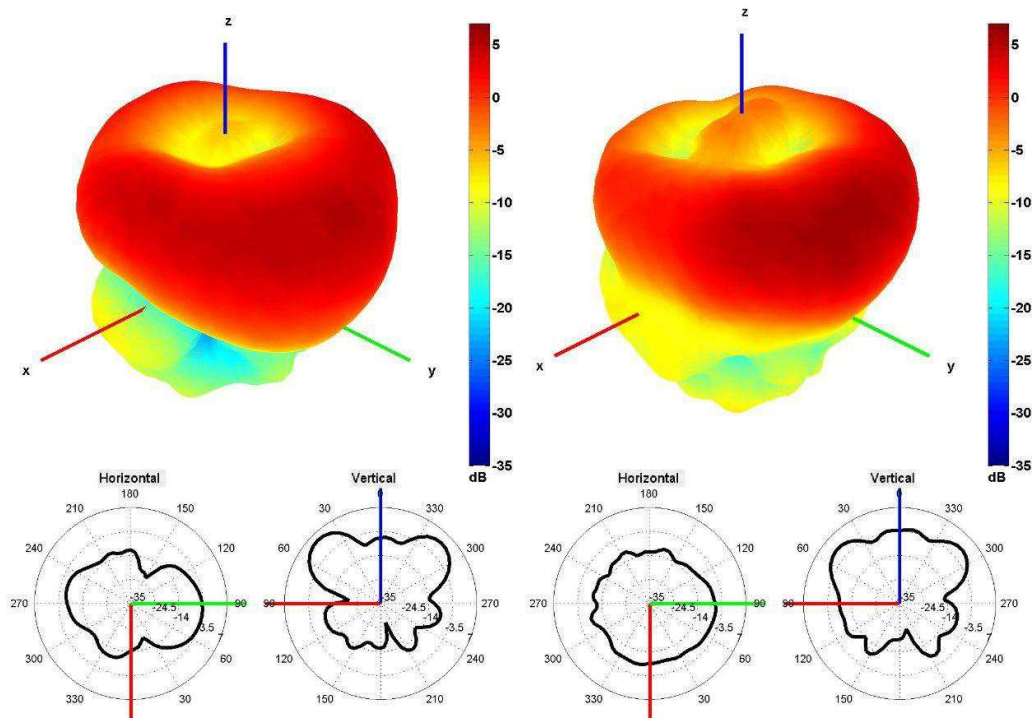

2350 and 2600 MHz Radiation pattern

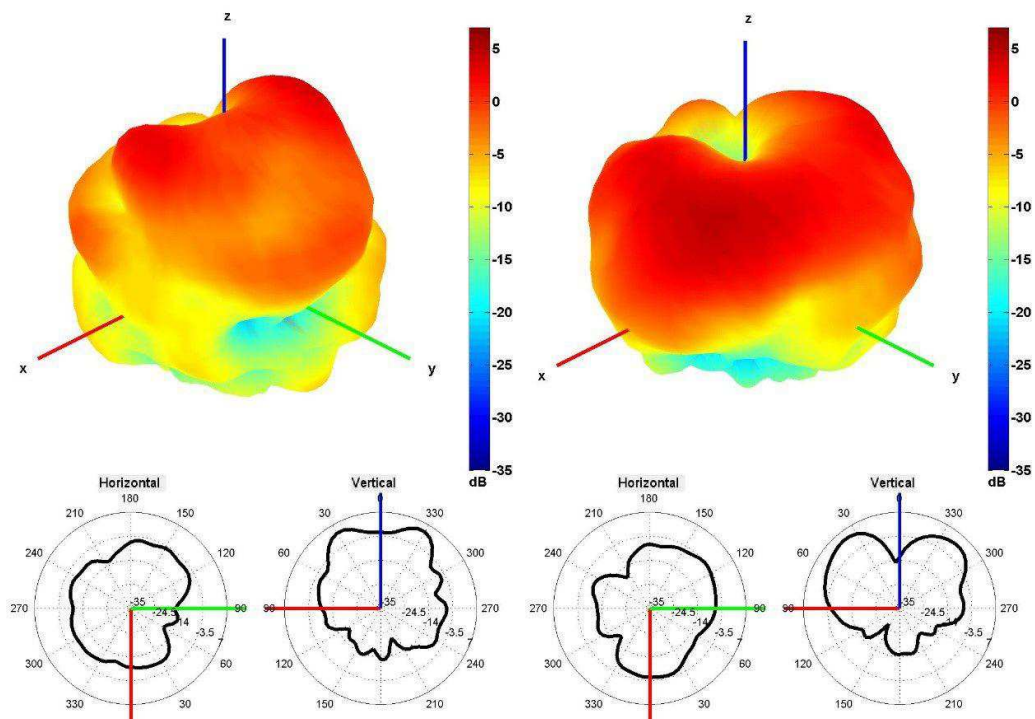

3350 and 3600 MHz Radiation pattern

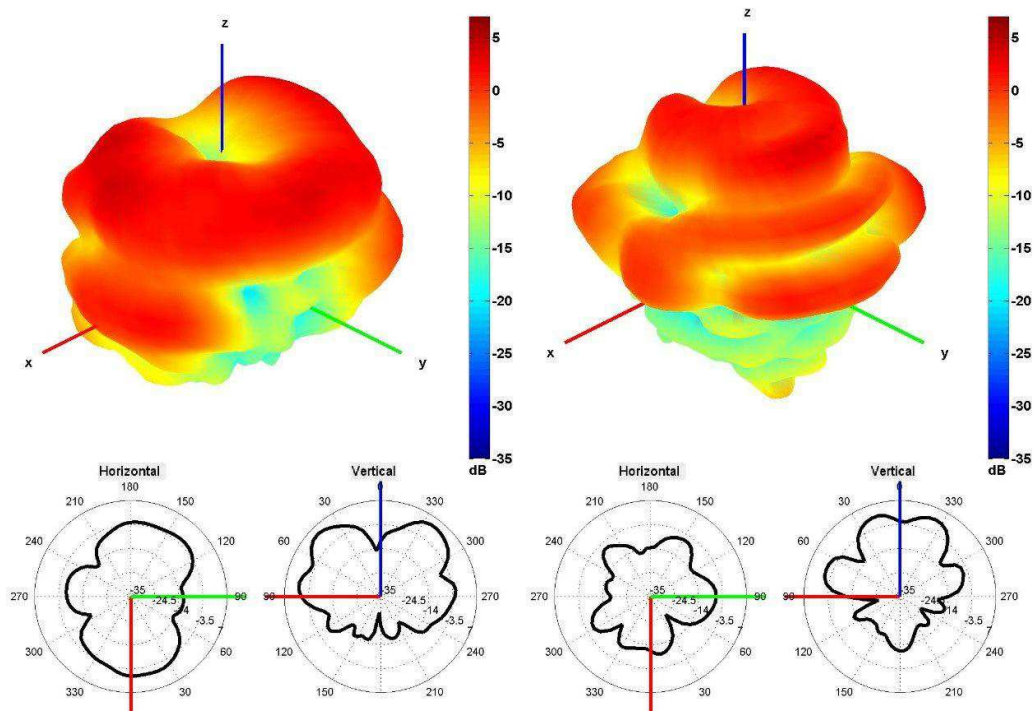

4500 and 5500 MHz Radiation pattern

Table 3: 5GNR

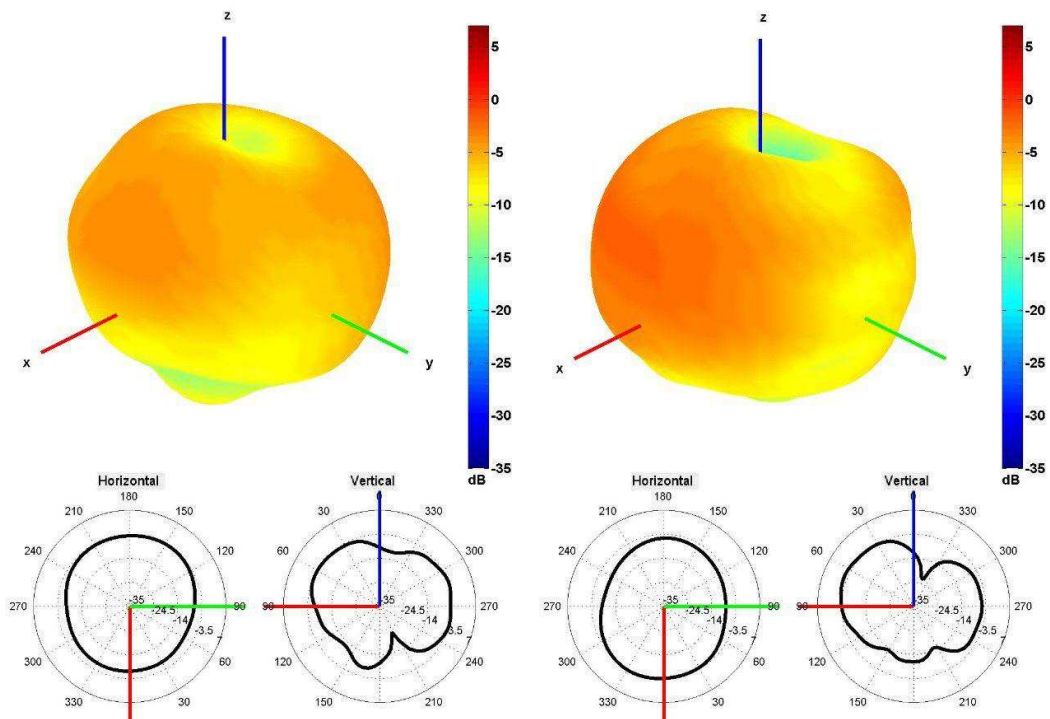

650 and 750 MHz Radiation pattern

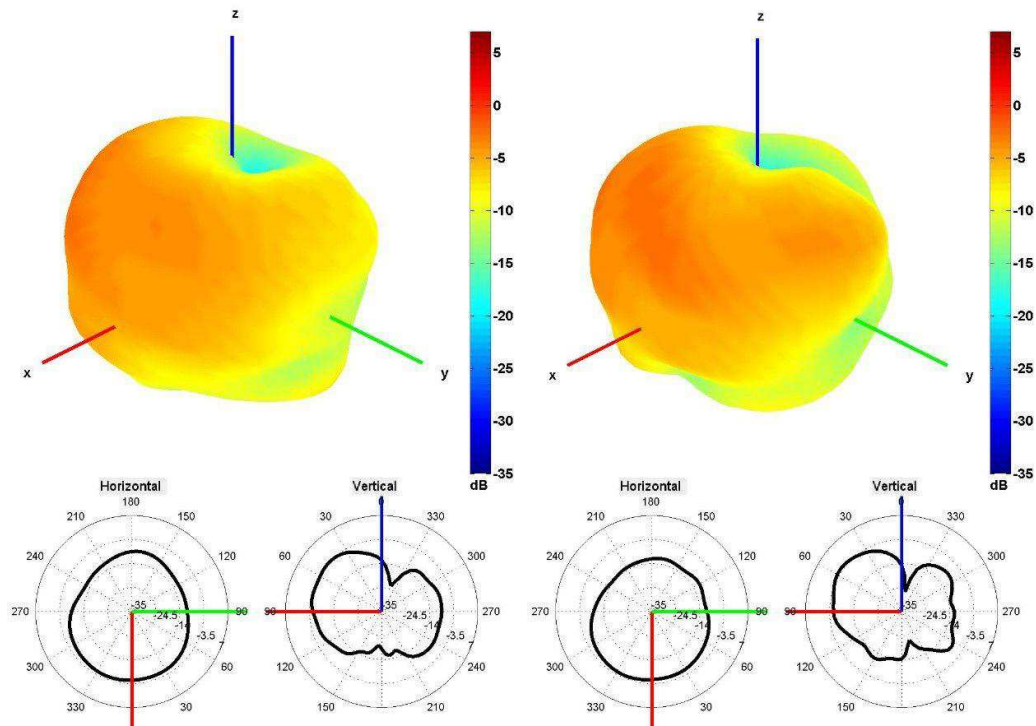

850 and 940 MHz Radiation pattern

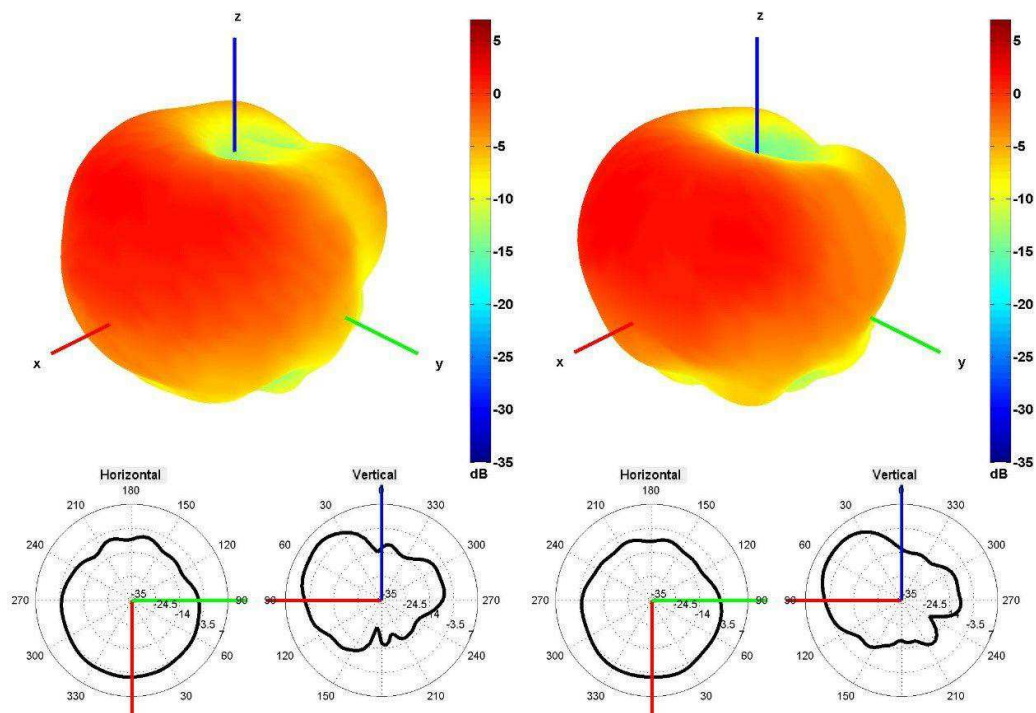

1500 and 1600 MHz Radiation pattern

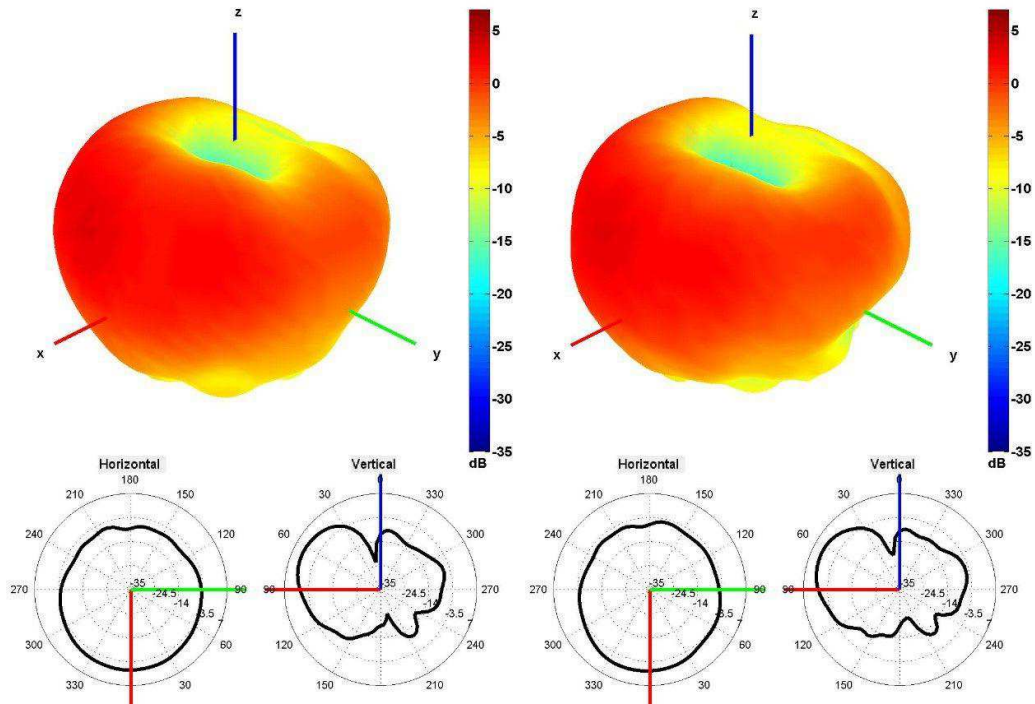

1750 and 1850 MHz Radiation pattern

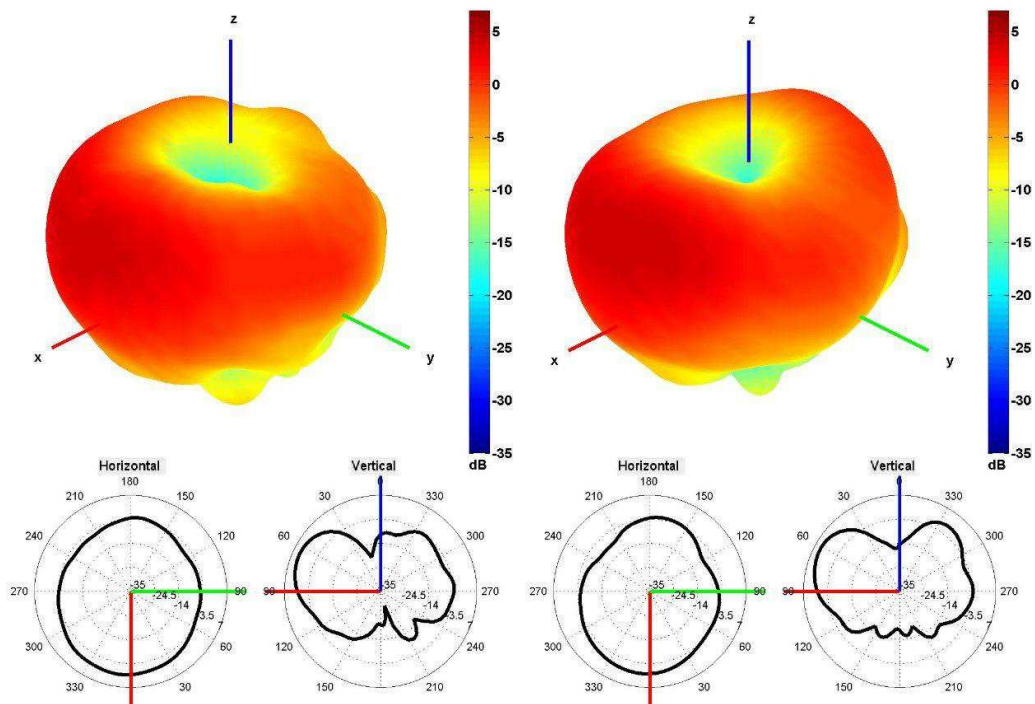

1950 and 2100 MHz Radiation pattern

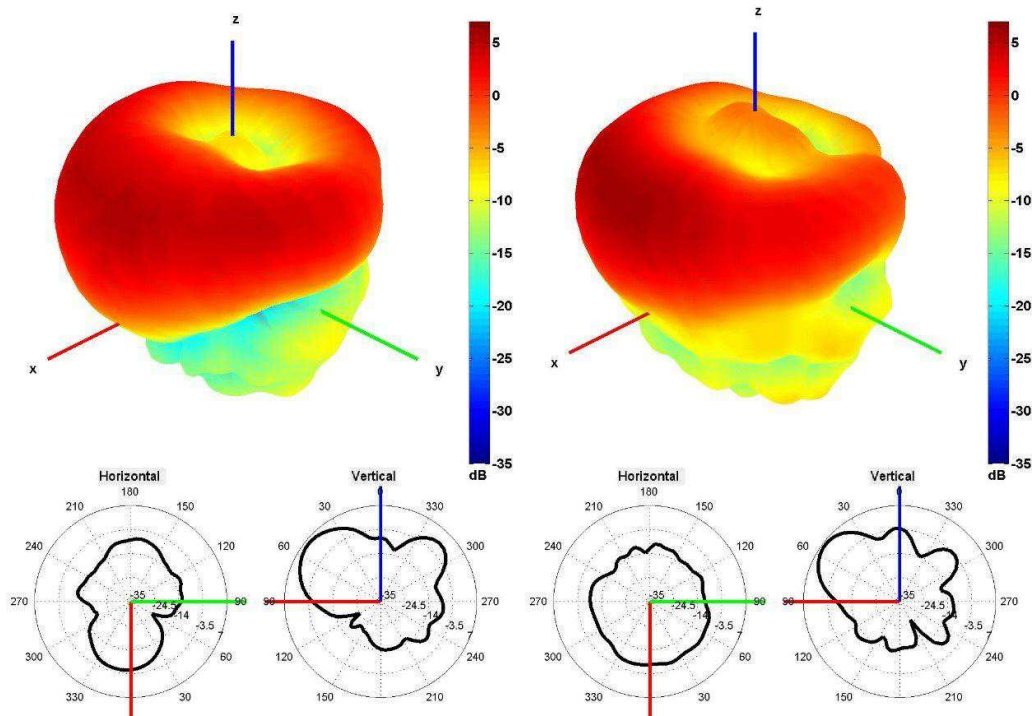

2350 and 2600 MHz Radiation pattern

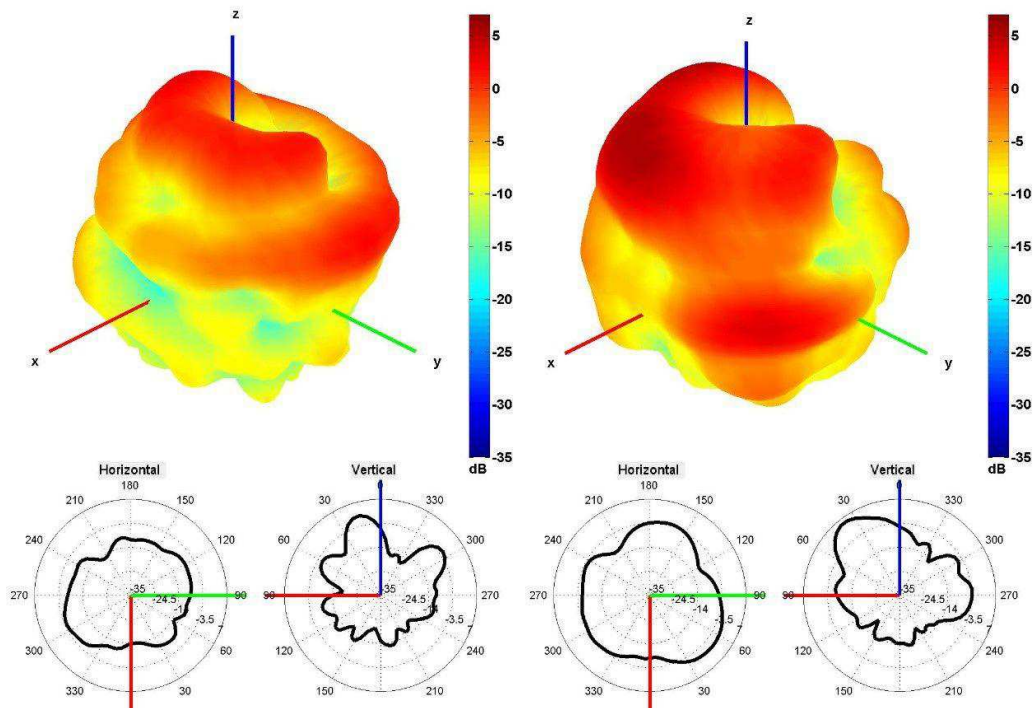

3350 and 3600 MHz Radiation pattern

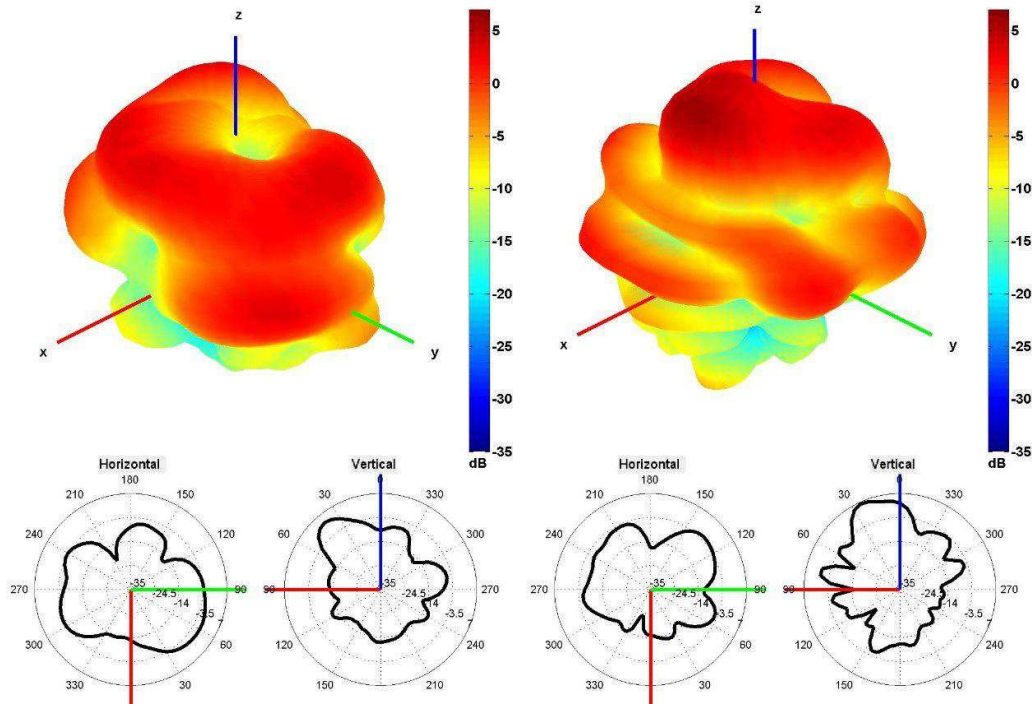

4500 and 5500 MHz Radiation pattern

Table 4: 5GNR

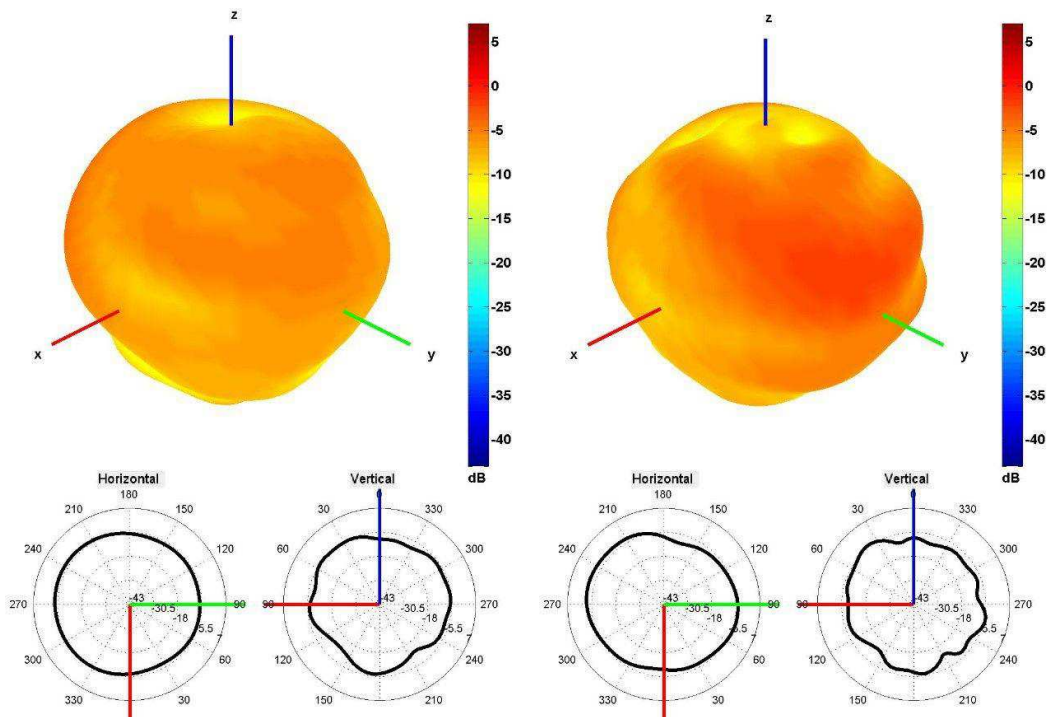

650 and 750 MHz Radiation pattern

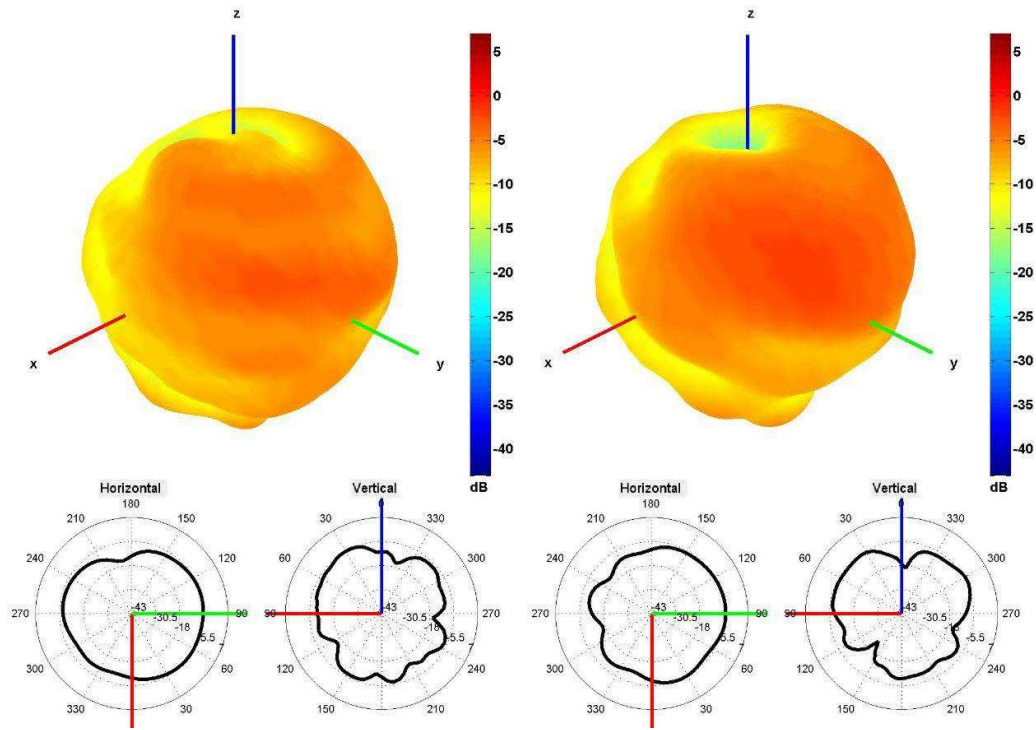

850 and 940 MHz Radiation pattern

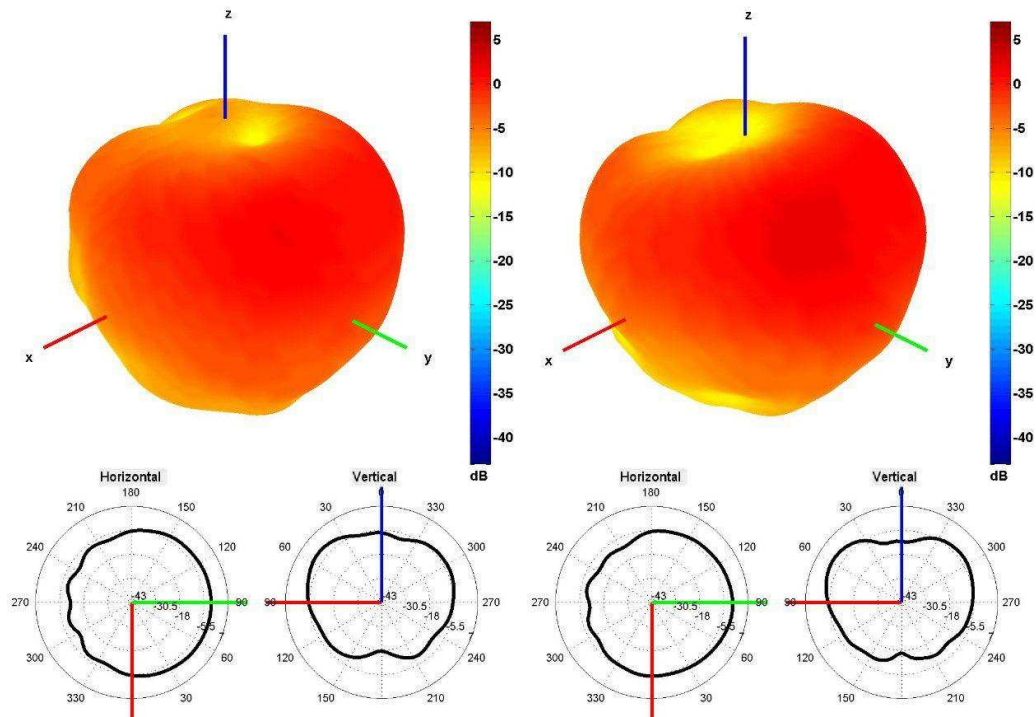

1500 and 1600 MHz Radiation pattern

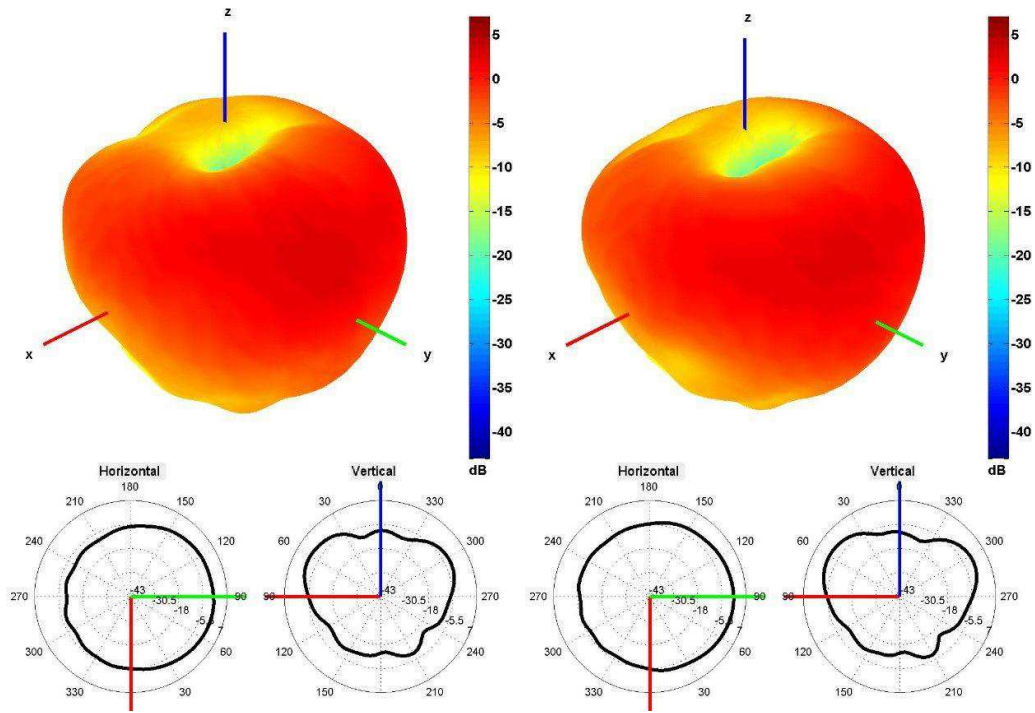

1750 and 1850 MHz Radiation pattern

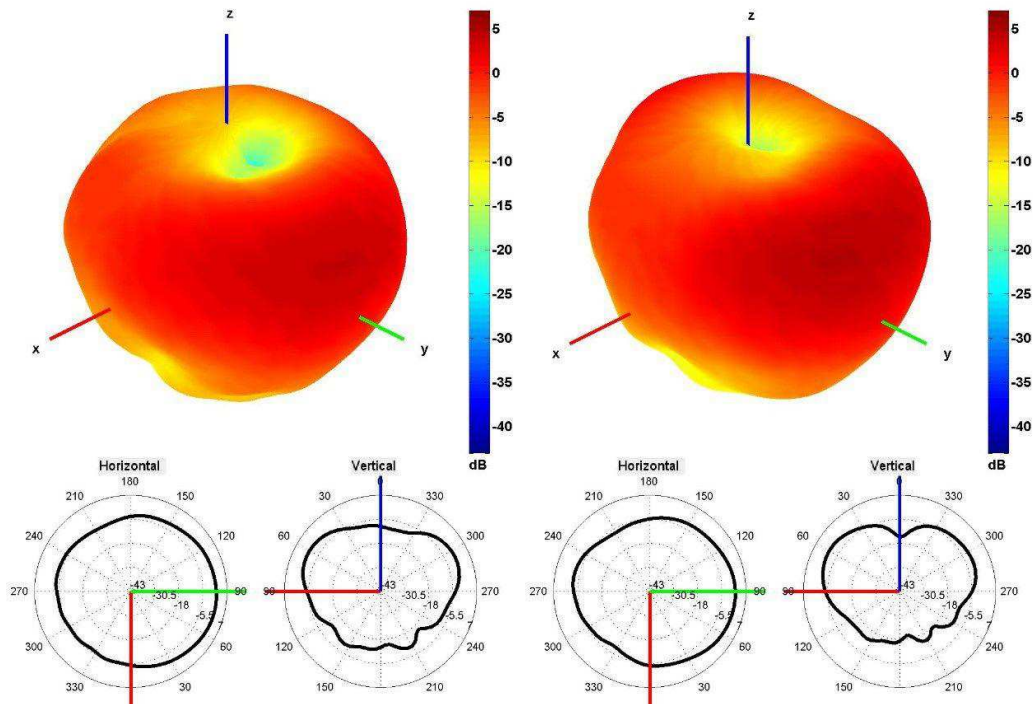

1950 and 2100 MHz Radiation pattern

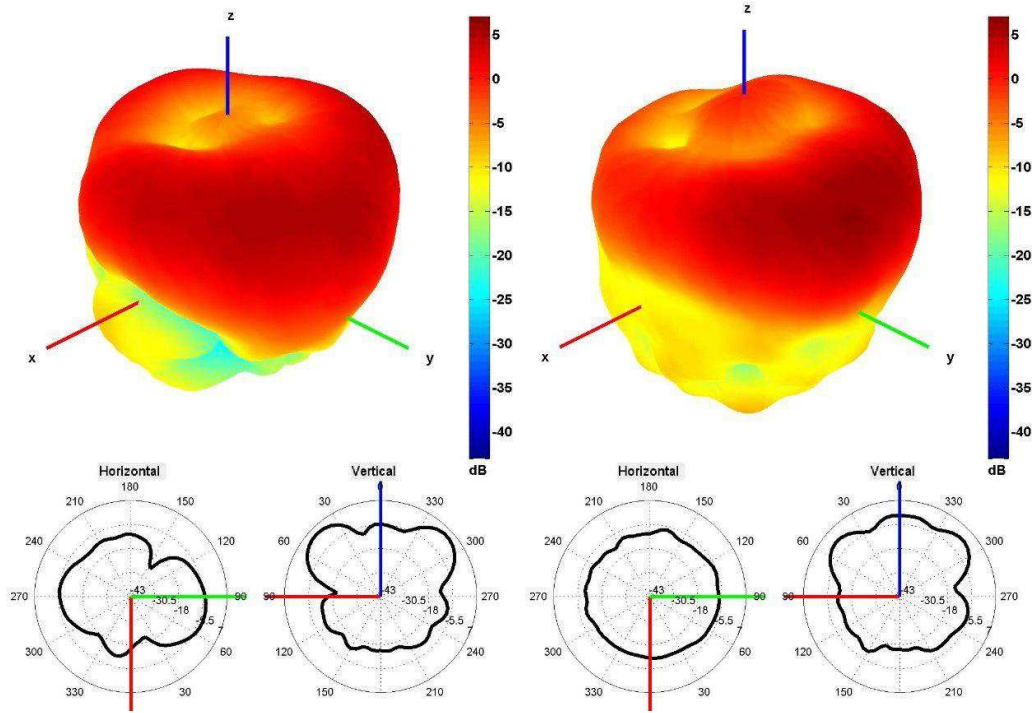

2350 and 2600 MHz Radiation pattern

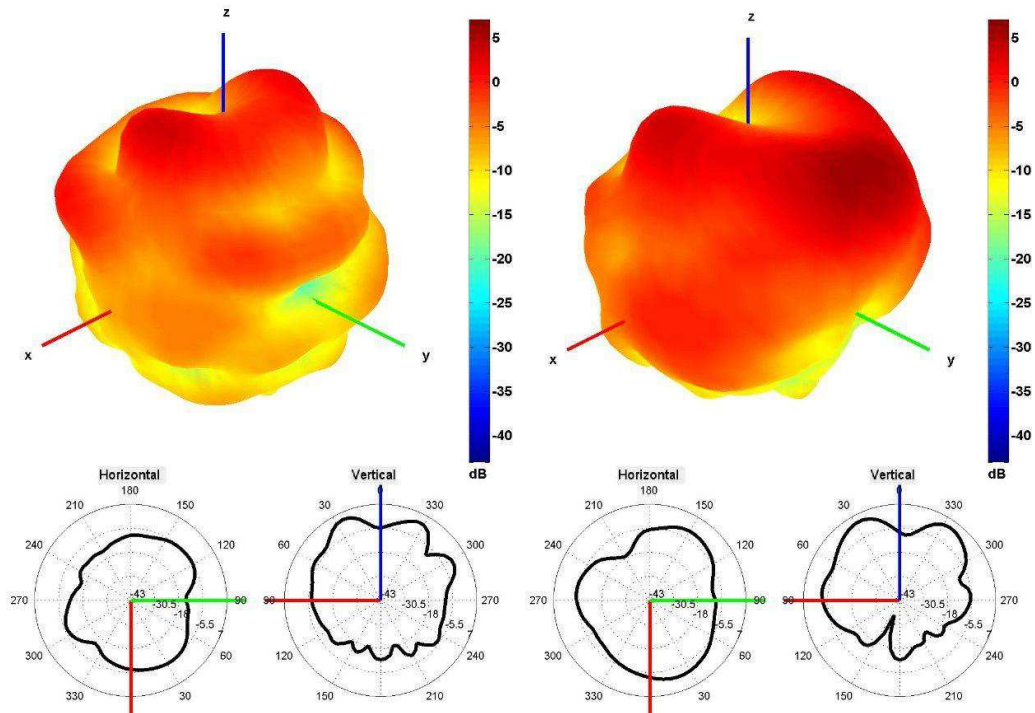

3350 and 3600 MHz Radiation pattern

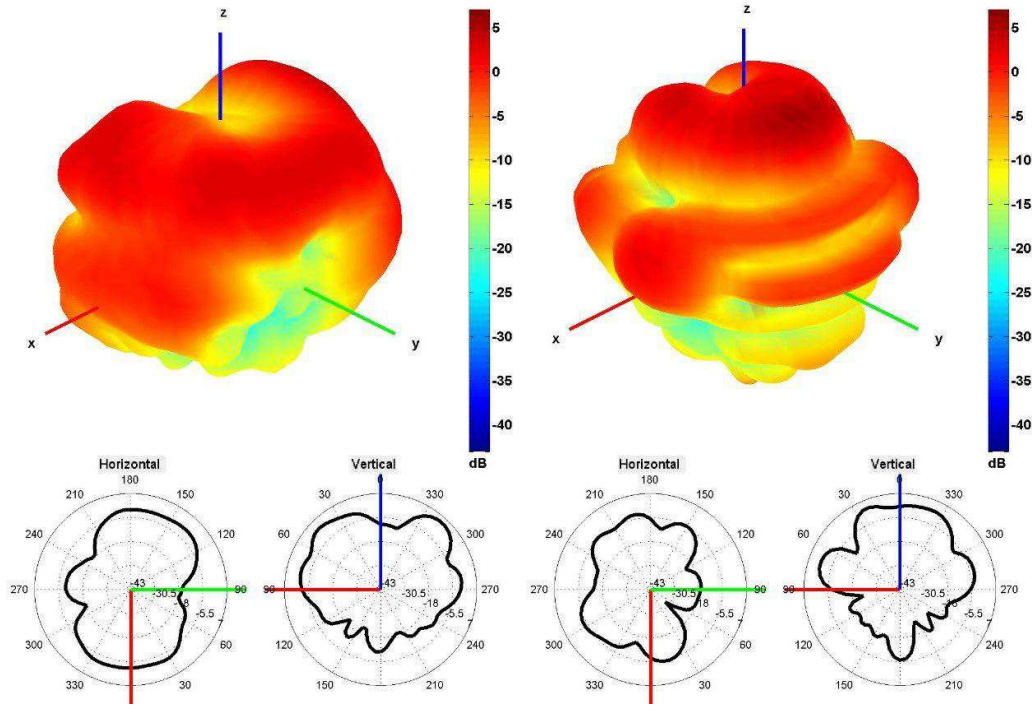

4500 and 5500 MHz Radiation pattern

4. Antenna drawings

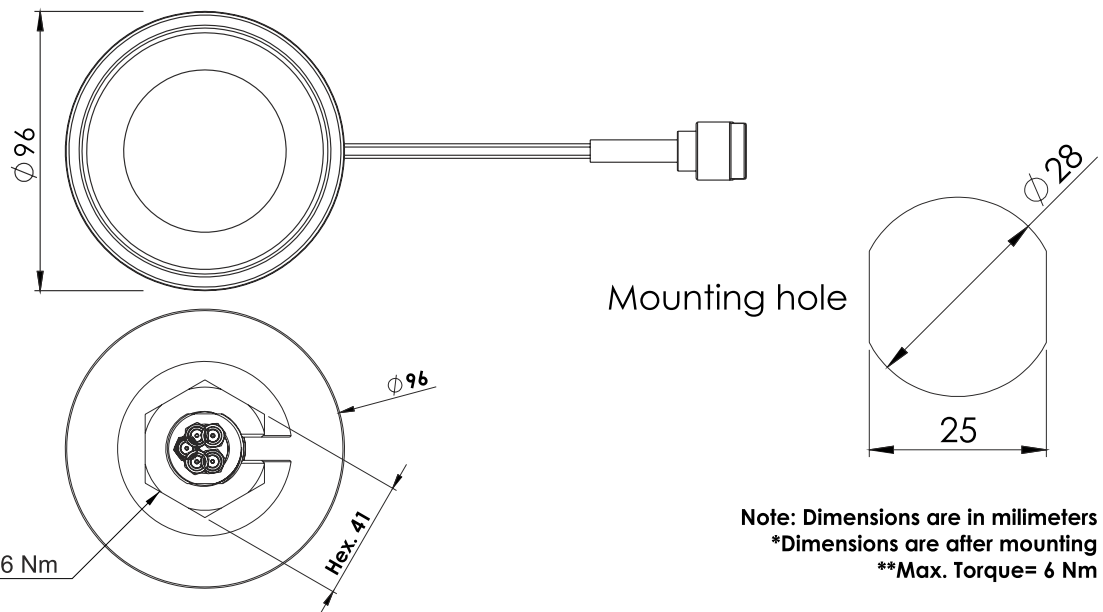
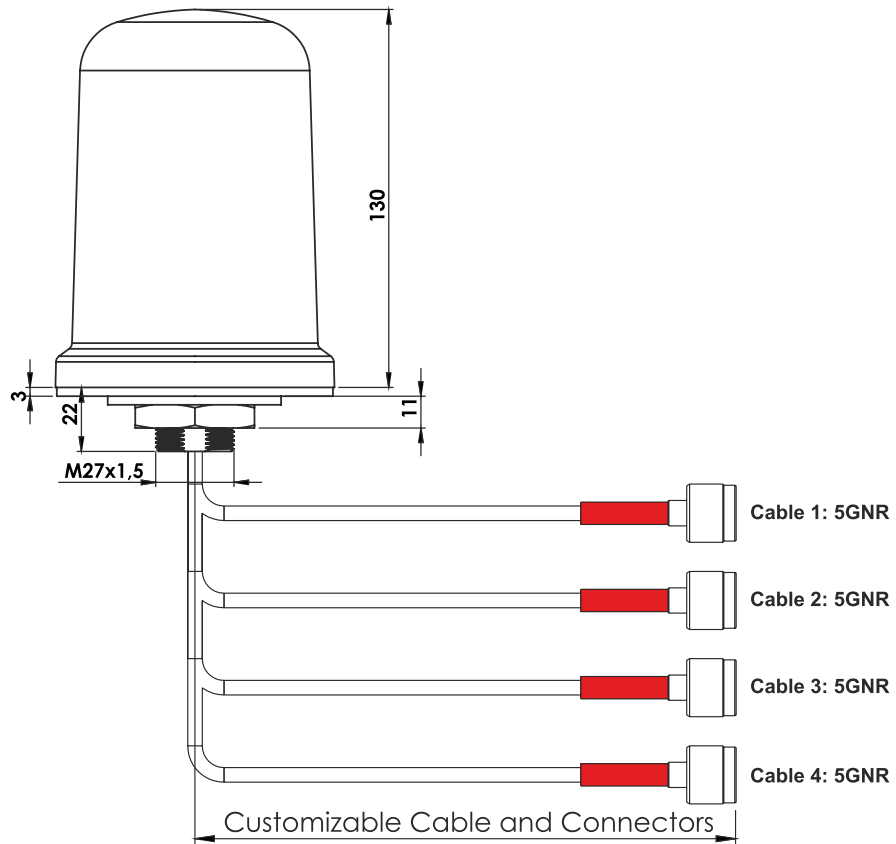

5. Antenna Images

