

DA-720-DPP Series Hardware User's Manual

Version 3.1, February 2019

www.moxa.com/product

MOXA®

© 2019 Moxa Inc. All rights reserved.

DA-720-DPP Series Hardware User's Manual

The software described in this manual is furnished under a license agreement and may be used only in accordance with the terms of that agreement.

Copyright Notice

© 2019 Moxa Inc. All rights reserved.

Trademarks

The MOXA logo is a registered trademark of Moxa Inc.
All other trademarks or registered marks in this manual belong to their respective manufacturers.

Disclaimer

Information in this document is subject to change without notice and does not represent a commitment on the part of Moxa.

Moxa provides this document as is, without warranty of any kind, either expressed or implied, including, but not limited to, its particular purpose. Moxa reserves the right to make improvements and/or changes to this manual, or to the products and/or the programs described in this manual, at any time.

Information provided in this manual is intended to be accurate and reliable. However, Moxa assumes no responsibility for its use, or for any infringements on the rights of third parties that may result from its use.

This product might include unintentional technical or typographical errors. Changes are periodically made to the information herein to correct such errors, and these changes are incorporated into new editions of the publication.

Technical Support Contact Information

www.moxa.com/support

Moxa Americas

Toll-free: 1-888-669-2872

Tel: +1-714-528-6777

Fax: +1-714-528-6778

Moxa Europe

Tel: +49-89-3 70 03 99-0

Fax: +49-89-3 70 03 99-99

Moxa India

Tel: +91-80-4172-9088

Fax: +91-80-4132-1045

Moxa China (Shanghai office)

Toll-free: 800-820-5036

Tel: +86-21-5258-9955

Fax: +86-21-5258-5505

Moxa Asia-Pacific

Tel: +886-2-8919-1230

Fax: +886-2-8919-1231

Table of Contents

1. Introduction	1-1
Overview	1-2
Model Descriptions and Package Checklist	1-2
Appearance	1-4
Dimensions	1-4
Features	1-5
Hardware Block Diagram	1-5
DA-720-DPP Basic System	1-5
Hardware Specifications	1-6
Basic Systems	1-6
2. Hardware Installation	2-1
Placement Options	2-2
Desk	2-2
Rack Mounting	2-2
Wiring Requirements	2-4
Connecting the Power	2-5
Wiring the Power Inputs	2-5
Reset Button	2-6
Front Panel LED	2-7
Connecting to a Display	2-8
Connecting USB Devices	2-9
Gigabit LAN Ports	2-9
Connecting a Serial Device	2-10
Connecting a Relay Device	2-11
Upgrading the Memory Module	2-11
Installing a mSATA Card	2-12
Installing SATA Hard Disk/Solid-state Disk	2-14
Installing and Removing Expansion Modules	2-16
DE-SP08-I-TB Serial Expansion Modules	2-19
DE-LN08-RJ/DE-LN04-RJ Ethernet Expansion Modules	2-20
DE-PRP-HSR-EF Ethernet Redundancy Expansion Modules	2-20
DE-2-SATA—2.5" Hot-pluggable HDD/SSD Expansion Modules	2-22
DE-2-IRIGB-4-DI/DO Time-synchronization Expansion Modules	2-23
Installing a USB Dongle Kit	2-24
3. BIOS Setup	3-1
Entering the BIOS Setup	3-2
Main Information	3-4
Advanced Settings	3-4
Boot Configuration	3-5
SATA Configuration	3-5
Internal Graphics Device	3-6
Miscellaneous Configuration	3-7
SIO ITE8768E	3-8
Console Redirection	3-9
Smart Recovery Info	3-10
Security Settings	3-10
Set Supervisor Password	3-10
Power Settings	3-11
Auto Wake on S5	3-11
Wake on LAN	3-12
Boot Settings	3-12
Boot Type	3-12
PXE Boot to LAN	3-12
Add Boot Options	3-12
Boot Delay Time	3-13
Automatic Failover	3-13
Boot Order Priority	3-13
Legacy Normal Boot Menu	3-13
Boot Type Order	3-13
EFI	3-13
Exit Settings	3-14
Exit Saving Changes	3-14
Save Change Without Exit	3-14
Exit Discarding Changes	3-14
Load Optimal Defaults	3-14
Load Custom Defaults	3-14
Save Custom Defaults	3-14
Discard Changes	3-14

Upgrading the BIOS	3-15
A. Safety Installation Instructions	A-1

1

Introduction

Thank you for purchasing a Moxa DA-720-DPP Series ready-to-run industrial computer.

This manual introduces you to the hardware installation, connector interfaces, and BIOS setup of the DA-720-DPP. For software configuration and management, please refer to the user's manual for the operating system installed on your computer.

The following topics are covered in this chapter:

- **Overview**
- **Model Descriptions and Package Checklist**
- **Appearance**
- **Dimensions**
- **Features**
- **Hardware Block Diagram**
 - DA-720-DPP Basic System
- **Hardware Specifications**
 - Basic Systems

Overview

The DA-720-DPP Series of computers are x86 platforms with 14 Gigabit Ethernet ports, 2 isolated RS-232/422/485 serial ports, USB, VGA, and 2 PCIe ports for expansion modules. The DA-720-DPP comes in a standard 19-inch 2U rack-mountable case. The DA-720-DPP's robust design is ideal for specialized industrial automation applications, including power substations, transportation and shipping, and oil and gas production and supply.

IEC 61850-3 and IEEE 1613 compliance ensures that the DA-720-DPP can deliver stable and reliable system operations in power applications. The DA-720-DPP also complies with the IEC 60255 standards to provide electrical protection relays for use in a smart substation. IEC 60255 is one of the most widely used standards for testing relays and protection equipment, and compliance with the standard ensures that DA-720-DPP will work reliably and efficiently with IEDs as a part of a robust substation automation system.

EN 50121-4 compliance ensures that the DA-720-DPP can deliver stable and reliable system operations in rail track-side applications.

The DA-720-DPP computer models come with two different CPU options and basic models that allow system designers to install mSATA interface, RAM, and operating system according to their specific requirements. This flexibility is particularly useful when designing customized industrial solutions.

The DA-720-DPP comes with 2 PCIe ports for expansion modules, which include 8-port RS-232/422/485 module as well as 4-port and 8-port 10/100/1000 Mbps LAN modules. The computer can support up to 22 Gigabit LAN ports plus 10 serial ports, or 14 Gigabit LAN ports and 18 serial ports, making the DA-720-DPP an ideal solution for a wide range of industrial automation applications.

Smart Recovery Function

The DA-720-DPP's Smart Recovery function minimizes downtime by making it easy to recover from operating system crashes. Engineers who are experts in a particular vertical market may not have enough computer domain knowledge to know how to fix operating system problems. Moxa Smart Recovery™ is an automated BIOS-level software recovery system that allows engineers to automatically trigger OS recovery to minimize downtime.

Proactive Monitoring Function

Moxa Proactive Monitoring is a small-footprint, resource-friendly, easy-to-use utility that allows users to track a number of system parameters. Users can view the current parameter values for these key parts by simply clicking on the icons corresponding to the parameters in the user interface. User-defined key part indicators (KPIs) are used to monitor the computer's key parts. Visual and/or audio alerts are triggered automatically via relay and SNMP traps when these KPIs go over their preset threshold values, making it extremely convenient for operators to avoid system downtime by setting up predictive maintenance tasks well in advance.

Model Descriptions and Package Checklist

The DA-720-DPP Series includes the following models:

- **DA-720-C5-DPP:** Rackmount computer with Core i5-6300U, 2.4 GHz, dual-core CPU, without mSATA/RAM/OS, 14 gigabit Ethernet ports, 2 isolated RS-232/422/485 ports, 2 PCIe expansion slots, VGA x 1, DVI-D x 1, 4 USB hosts, IEC 61850-3 compliant, -25 to 55°C operating temperature
- **DA-720-C5-DPP-LX:** Rackmount computer with Core i5-6300U, 2.4 GHz, dual-core CPU, with 8G mSATA, 4G RAM and Linux Debian 8 64-bit OS preinstalled, 14 gigabit Ethernet ports, 2 isolated RS-232/422/485 ports, 2 PCIe expansion slots, VGA x 1, DVI-D x 1, 4 USB hosts, IEC 61850-3 compliant, -25 to 55°C operating temperature
- **DA-720-C7-DPP:** Rackmount computer with Core i7-6600U, 2.6 GHz dual-core CPU without mSATA/RAM/OS, 14 gigabit Ethernet ports, 2 isolated RS-232/422/485 ports, 2 PCIe expansion slots, VGA x 1, DVI-D x 1, 4 USB hosts, IEC 61850-3 compliant, -25 to 55°C operating temperature

- **DA-720-C7-DPP-LX:** Rackmount computer with Core i7-6600U, 2.6 GHz dual-core CPU, with 8G mSATA, 4G RAM and Linux Debian 8 64-bit OS preinstalled, 14 gigabit Ethernet ports, 2 isolated RS-232/422/485 ports, 2 PCIe expansion slots, VGA x1, DVI-D x 1, 4 USB ports, IEC 61850-3 compliant, -25 to 55°C operating temperature

NOTE To order a DA-720 system with a pre-installed Windows 10 Enterprise LTSB 64 Bit OS, please contact a Moxa sales representative.

Each model ships with following additional items:

- DA-720-DPP embedded computer
- Rackmount kit
- Quick installation guide (printed)
- Warranty card

Optional DA-720 Expansion Modules (can be purchased separately)

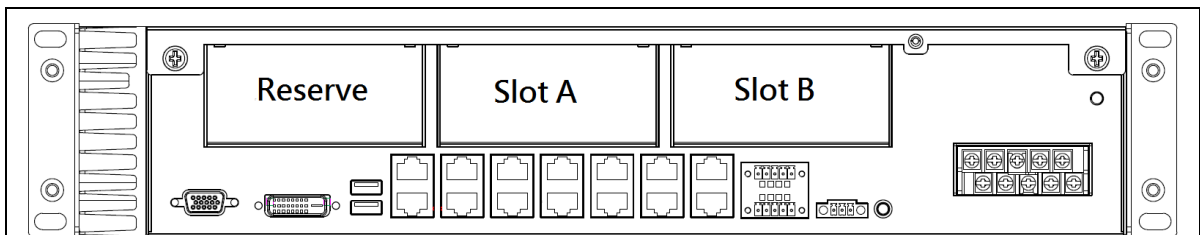

Expansion Module	Description	Reserve Slot	Module Slot A	Module Slot B
DE-LN04-RJ	4-port 100/1000 Mbps PCIe LAN module	N/A (Bandwidth Limitation)	✓	N/A (Bandwidth Limitation)
DE-LN08-RJ	8-port 100/1000 Mbps PCIe LAN module	N/A (Bandwidth Limitation)	✓	N/A (Bandwidth Limitation)
DE-2-SATA	2x 2.5" SATA III SSD/HDD socket Module	✓	✓	N/A (Heat Limitation)
DE-PRP-HSR-EF	2-Port 100/1000 Mbps PCIe PRP/HSR LAN module	✓	✓	N/A (Heat Limitation)
DE-SP08-I-TB	8-port RS-232/422/485 PCIe serial module	✓	✓	✓
DE-2-IRIGB-4-DI/DO	2-port IRIG-B signal input module with 4 digital inputs, 4 digital outputs	✓	✓	✓

NOTE Additional expansion modules are currently under development. Refer to the "DA-720 Expansion Module Datasheet" and the DA-720 software user's manuals for detailed information.

Appearance

Front View

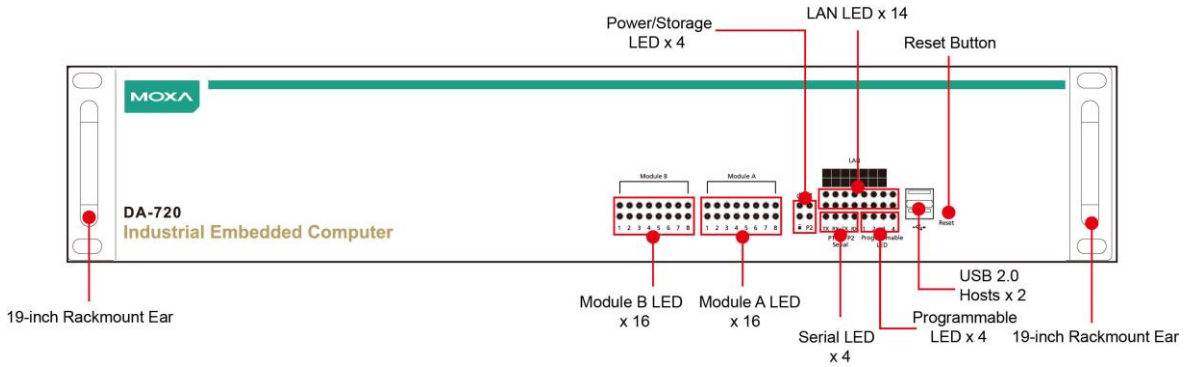

Rear View

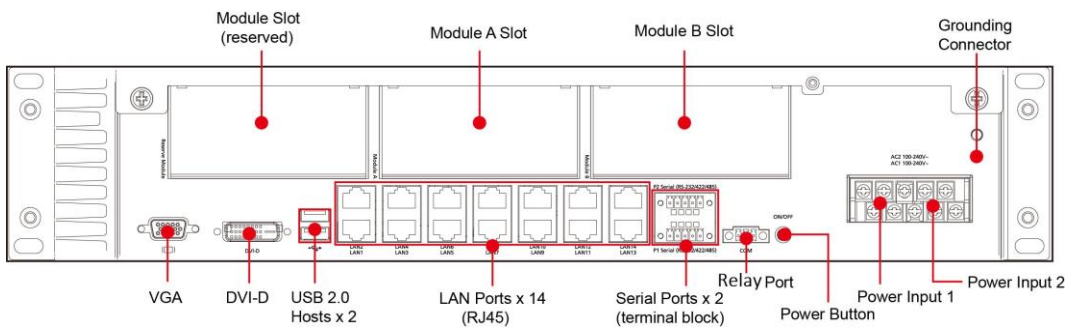

Dimensions

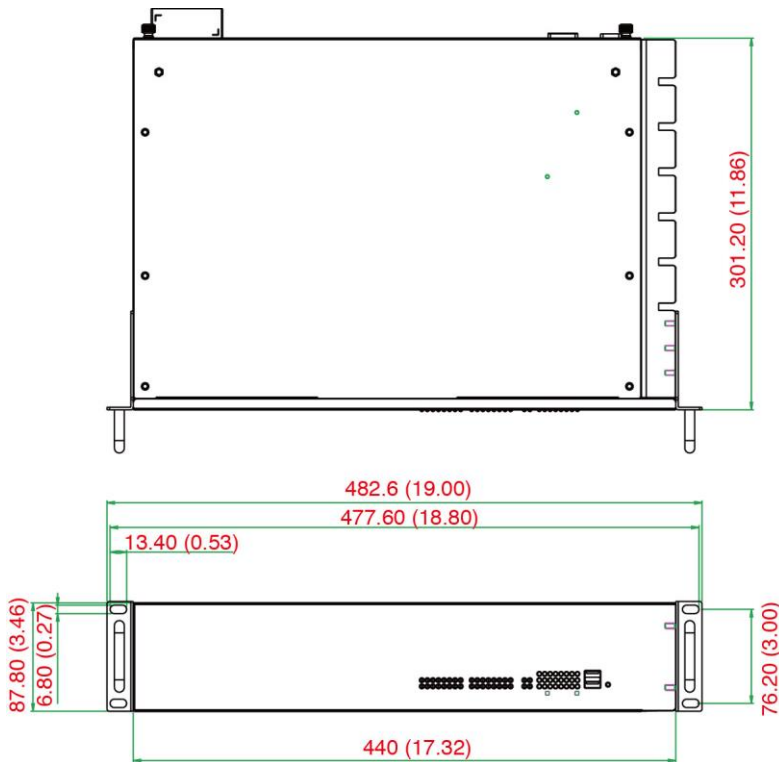

Features

The DA-720-DPP computer has the following features:

- 6th Gen Intel® Core™ i7/i5 CPU (Skylake)
- 2 built-in DDR4 memory sockets
- 1 mSATA for OS and 1 SATA III for storage expansion
- 14 Gigabit Ethernet ports for network redundancy
- 2 PCIe expansion slots for expansion modules
- 4 USB ports for high-speed peripherals
- 2 isolated RS-232/422/485 ports
- Embedded Debian 8 Linux (Windows 10 by CTOS)
- Supports 110 to 240 VDC and 100 to 240 VAC power inputs

Hardware Block Diagram

DA-720-DPP Basic System

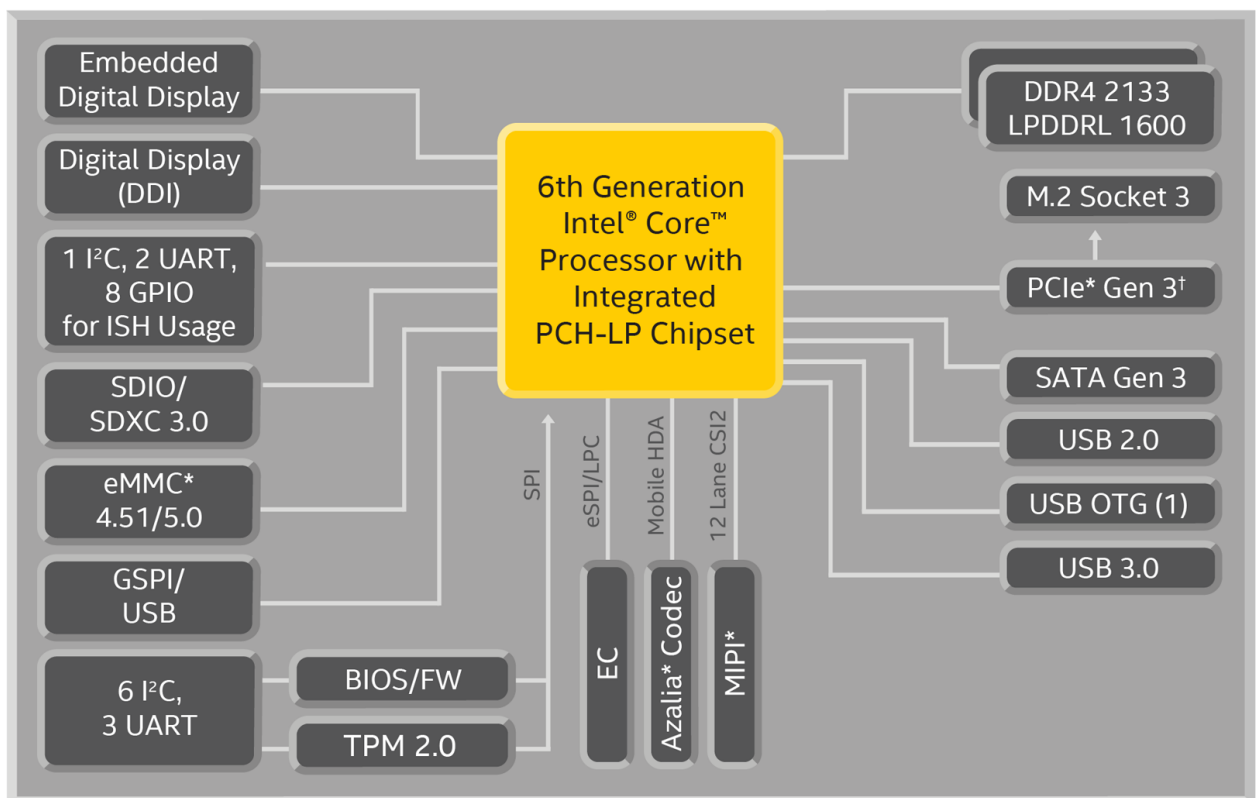

† Gen 3.0 available on premium PCH only. Gen 2.0 available on base PCH SKUs.

Hardware Specifications

Basic Systems

Computer

CPU: Intel 6th Gen Skylake Processor (BGA CPU package)

- Core i5-6300U, 2.4 GHz, dual-core CPU
- Core i7-6600U, 2.6 GHz, dual-core CPU

OS: Linux Debian 8 (pre-installed)

Note: Windows 10 Enterprise LTSB 64-bit available by CTOS

System Chipset: Intel® HD Graphics 520

BIOS: 128 Mbit Flash BIOS, Plug & Play, ACPI

System Memory: 32 GB capacity, 4 GB for Linux Debian 8 pre-installed; 2 slots for DDR4 SO-DIMM

USB: 4 USB ports, system bootable, type A connector

Front: 2 USB 2.0 ports

Rear: 2 USB 3.0 ports

Storage

Built-in: 8 GB industrial mSATA to store 64-bit Debian 8 Linux OS

Storage Expansion:

- 1 x SATA 3.0

Display

Graphics Controller: Intel® HD Graphics 520

Display Interface: 1 VGA output (DB15 female connector) and 1 DVI-D

Resolution:

- VGA: CRT display mode with pixel resolution up to 1920 x 1200 @ 60 Hz
- DVI-D: Display mode with pixel resolution up to 1920 x 1200 @ 60 Hz

Ethernet Interface

LAN: Auto-sensing 10/100/1000 Mbps ports x 14

Magnetic Isolation Protection: 1.5 kV built-in

Serial Interface

Serial Standards: 2 RS-232/422/485 ports (terminal block)

ESD Protection: 8 kV contact, 15 kV air

Surge Protection: 2 kV line-to-line and 4 kV line-to-ground surge protection, 8/20 μ s waveform

Insulation: 500 V

Isolation: 2 kV

Pull low/high: 150k

Flow Control: Not supported

Baudrate: 50 bps to 115.2 kbps

Serial Signals

RS-232: TxD, RxD, RTS, CTS, GND

RS-422: TxD+, TxD-, RxD+, RxD-, GND

RS-485-4w: TxD+, TxD-, RxD+, RxD-, GND

RS-485-2w: Data+, Data-, GND

LEDs

System: Power, Storage

LAN: Link or Active

Serial: 2

Programmable: 4 LEDs

Communication: Module A x 16, Module B x 16

Switches and Buttons

Power Button: On/Off (on rear panel)

Reset Button: Hard Reset (on front panel)

Physical Characteristics

Housing: SECC sheet metal (1 mm)

Weight: 6.5 kg (14.33 lb)

Dimensions: 440 x 301 x 90 mm (17.32 x 12.20 x 3.54 in) (without rackmount ears)

Mounting: Standard 19-inch rack

Environmental Limits

Operating Temperature: -25 to 55°C (-13 to 131°F)

Storage Temperature: -40 to 85°C (-40 to 185°F)

Ambient Relative Humidity: 5 to 95% (non-condensing)

Anti-Vibration: 3 mm (2-9 Hz), 10 m/s² (9-200 Hz), 15 m/s² (200-500 Hz) @ IEC-61850-3, IEC 60870-2-2/Bm/(3M6)/(4M6), sine wave, 2-500 Hz, 1 Oct/min, 10 cycles, 2 hrs 40 mins per axis

Anti-Shock: 100 m/s² @ IEC-61850-3, IEC 60870-2-2/Bm/(3M6)/ (4M6), half sine wave, 11 ms

Power Requirements

Input Voltage: 100 to 240 VAC; 100 to 240 VDC

Input Current: 0.82 A@100 VAC, 0.77 A@110 VDC

Standards and Certifications

Safety: UL 60950-1, IEC 60950-1, EN 60950-1

Electrical Substation: IEC 61850-3, IEEE 1613, IEC 60255

Railway: EN 50121-4

Protection Relay: IEC 60255

EMC: EN 55032/24

EMI: CISPR 22, FCC Part 15B Class A

EMS:

IEC 61000-4-2 ESD: Contact: 8 kV; Air: 15 kV

IEC 61000-4-3 RS: 80 MHz to 1 GHz: 20 V/m

IEC 61000-4-4 EFT: Power: 4 kV; Signal: 4 kV

IEC 61000-4-5 Surge: Power: 4 kV; Signal: 4 kV

IEC 61000-4-6 CS: 10 V

IEC 61000-4-8

IEC 61000-4-11

Green Product: RoHS, CRoHS, WEEE

Reliability

Alert Tools:

- Built-in buzzer and RTC (real-time clock) with lithium battery backup
- Built-in relay for audio/visual alarm

Automatic Reboot Trigger: Built-in watchdog timer, configurable for restarts at 1 to 255 second intervals

MTBF (mean time between failures)

Time: 138,319 hrs

Warranty

Warranty Period: 3 years

Details: See www.moxa.com/warranty

Hardware Installation

The DA-720-DPP Series of computers are x86 platforms with 14 Gigabit Ethernet ports, 2 isolated RS-232/422/485 serial ports, USB, VGA, and 2 PCIe ports for expansion modules. The DA-720-DPP comes in a standard 19-inch 2U rack-mountable case. The DA-720-DPP's robust design is ideal for specialized industrial automation applications, including power substations, transportation and shipping, and oil and gas production and supply.

The DA-720-DPP is provided with 2 PCIe ports for expansion modules that include 8-port RS-232/422/485 module as well as 4-port and 8-port 10/100/1000 Mbps LAN modules. The computer can support up to 22 Gigabit LAN ports plus 10 serial ports or 14 Gigabit LAN ports and 18 serial ports, making the DA-720-DPP an ideal solution for a wide range of industrial automation applications.

The following topics are covered in this chapter:

□ Placement Options

- Desk
- Rack Mounting

□ Wiring Requirements

□ Connecting the Power

- Wiring the Power Inputs

□ Reset Button

□ Front Panel LED

□ Connecting to a Display

□ Connecting USB Devices

□ Gigabit LAN Ports

□ Connecting a Serial Device

□ Connecting a Relay Device

□ Upgrading the Memory Module

□ Installing a mSATA Card

□ Installing SATA Hard Disk/Solid-state Disk

□ Installing and Removing Expansion Modules

□ DE-SP08-I-TB Serial Expansion Modules

□ DE-LN08-RJ/DE-LN04-RJ Ethernet Expansion Modules

□ DE-PRP-HSR-EF Ethernet Redundancy Expansion Modules

□ DE-2-SATA—2.5" Hot-pluggable HDD/SSD Expansion Modules

□ DE-2-IRIGB-4-DI/DO Time-synchronization Expansion Modules

□ Installing a USB Dongle Kit

Placement Options

Desk

Place your DA-720-DPP on a clean, flat desk. For better ventilation, leave some space between the DA-720-DPP and other equipment. Do not place equipment or objects on top of the DA-720-DPP, as this might damage the computer's internal components.

Rack Mounting

The DA-720-DPP comes with a mounting kit for installing the embedded computer on a standard rack.



ATTENTION

1. For maximum safety, at least two persons should work together to lift, place, and install the computer on the rack.
2. Before you lift or move the computer, make sure that the power supply to the computer and the rack system are turned off.

Four screws are required to attach the DA-720-DPP to a standard rack.

Step 1: Check the contents of the packages

Two supports, one for each side, are provided with the DA-720-DPP. Each package should contain 1 bracket, 1 handle, 2 FMSM5X10 screws, and 6 FMSM4X6 screws. Remove the contents out of the packages.

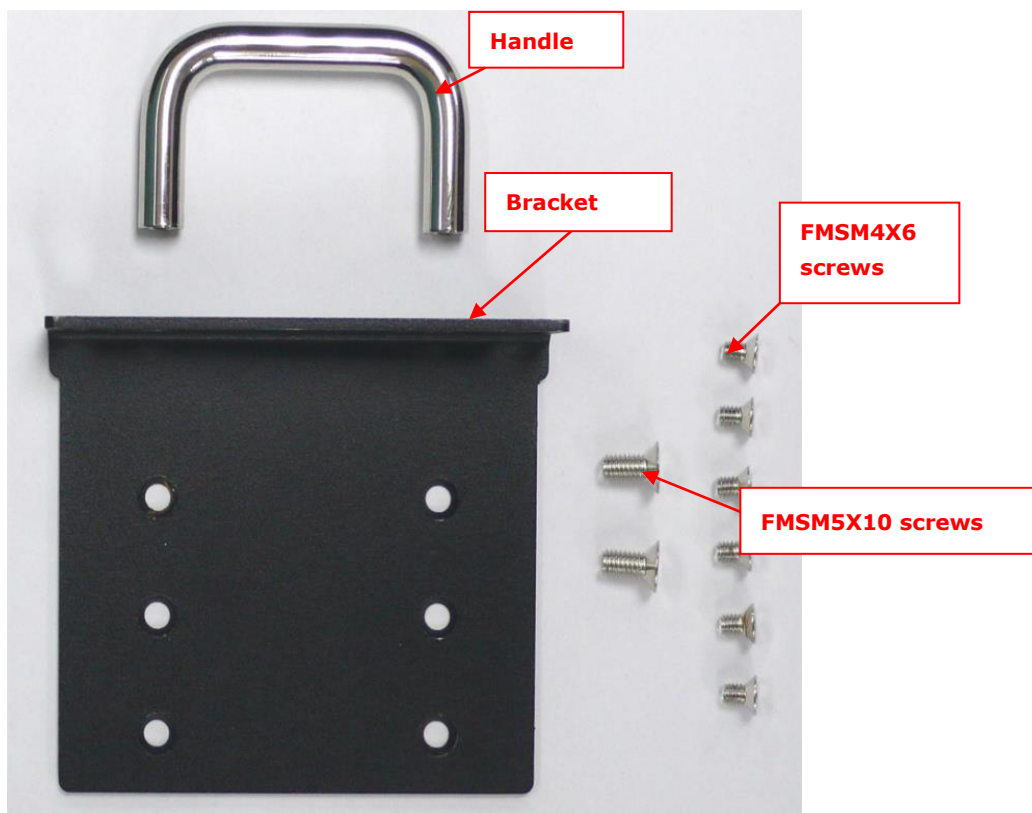

Step 2: Install the handles

Use 4 FMSM5X10 screws (2 on each bracket) to attach the handles to the brackets.

**Step 3: Install the brackets**

Use 6 FMSM4X6 screws to attach a bracket to one side of the DA-720-DPP. Repeat this procedure on the other side.

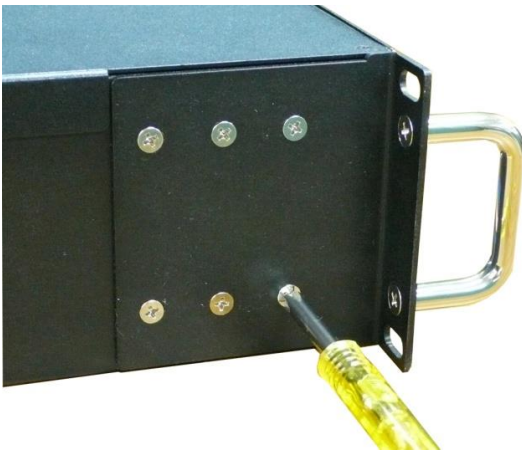
**Step 4: Installing the DA-720-DPP on a rack.**

Gently slide the DA-720-DPP onto the rack, and then use screws (provided by the rack supplier) to fix the bracket to the rail.



Use two screws on the left side and two screws on the right side. Check to make sure that the four screws are firmly attached to the rack.

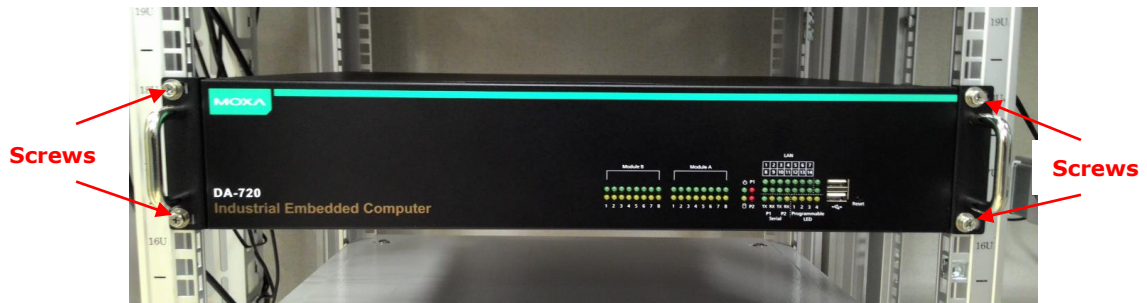

Wiring Requirements

The following common safety precautions should be observed before installing any electronic device:

- Keep power wires and communications/signals wires in separate paths. If power and communications/signal wires must cross paths, make sure the wires are perpendicular at the intersection point.
- Use the type of signal transmitted through a wire to determine which wires should be bundled together and which kept separate. The rule of thumb is that wiring that carries similar electrical signals can be bundled together.
- We strongly recommend that you label the wiring for all devices in the system for easy identification.



ATTENTION

Do not run signal or communication wiring and power wiring in the same wire conduit. To avoid interference, wires with different signal characteristics should be routed separately.



ATTENTION

Safety First!

Be sure to disconnect the power cord before installing and/or wiring your device.

Electrical Current Caution!

Calculate the maximum possible current in each power wire and common wire. Observe all electrical codes dictating the maximum current allowable for each wire size. If the current goes above the maximum ratings, the wiring could overheat, causing serious damage to your equipment.

Temperature Caution!

Be careful when handling the unit. When the unit is plugged in, the internal components generate heat, and consequently the outer casing may feel hot to the touch.

Connecting the Power

After you have connected the power cords to the power input unit, the system will automatically boot up. Depending on the operating system, the boot up process can take about 30 to 60 seconds.

Wiring the Power Inputs

Pin Assignment

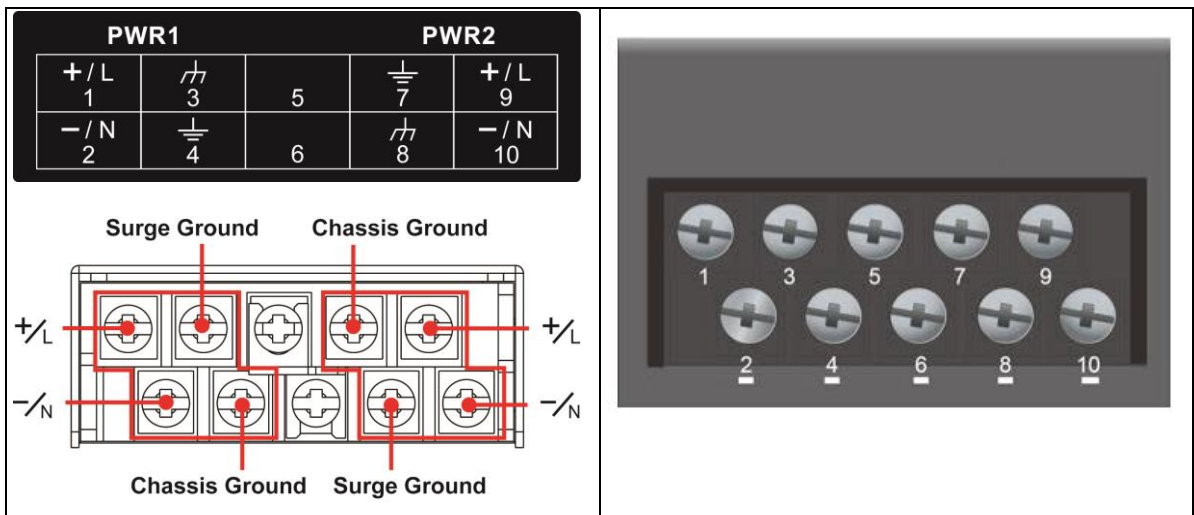

Power Input Wiring Description

Terminal Number	Description	Note
1	PWR1 Line/DC+	PWR1 Line/DC+ is connected to the positive (+) terminal if the power source is DC, or to the line terminal if the power source is AC.
2	PWR1 Neutral/DC-	PWR1 Neutral/DC- is connected to the negative (-) terminal if the power source is DC, or to the neutral terminal if the power source is AC.
3	NC	Reserved for future customization.
4	Signal Ground	Signal Ground should be connected to the ground terminal for AC power source 1.
5	NC	Reserved for future customization.
6	NC	Reserved for future customization.
7	Signal Ground	Signal Ground should be connected to the ground terminal for AC power source 2.
8	NC	Reserved for future customization.
9	PWR2 Line/DC+	PWR2 Line/DC+ is connected to the positive (+) terminal if the power source is DC, or to the line terminal if the power source is AC.
10	PWR2 Neutral/DC-	PWR2 Neutral/DC- is connected to the negative (-) terminal if the power source is DC, or to the neutral terminal if the power source is AC.

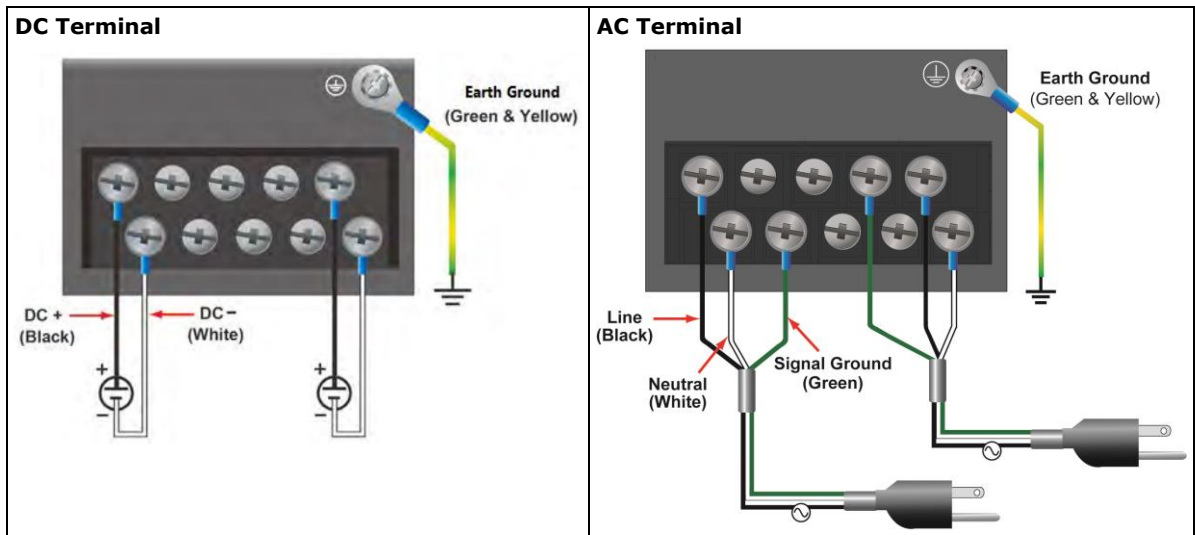

Reset Button

Pressing the Reset button initiates a hardware warm reboot. The button plays the same role as a desktop PC’s reset button. After you press the reset button, the system will reboot automatically. During normal use, you should NOT use the Reset Button. You should only use this button if the software is not working properly. To protect the integrity of data being transmitted or processed, you should always reset the system from the operating system with the software reboot function.

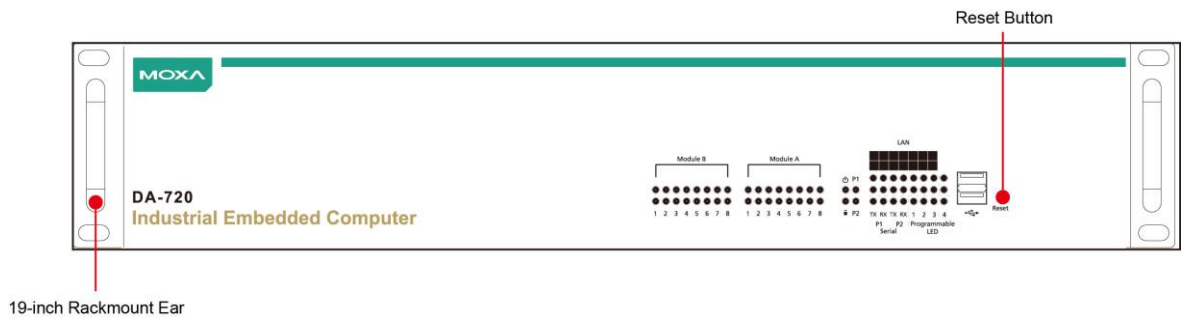

Front Panel LED

The computer is provided with 60 LED indicators on the front panel. Information about the LEDs is listed in the following table:

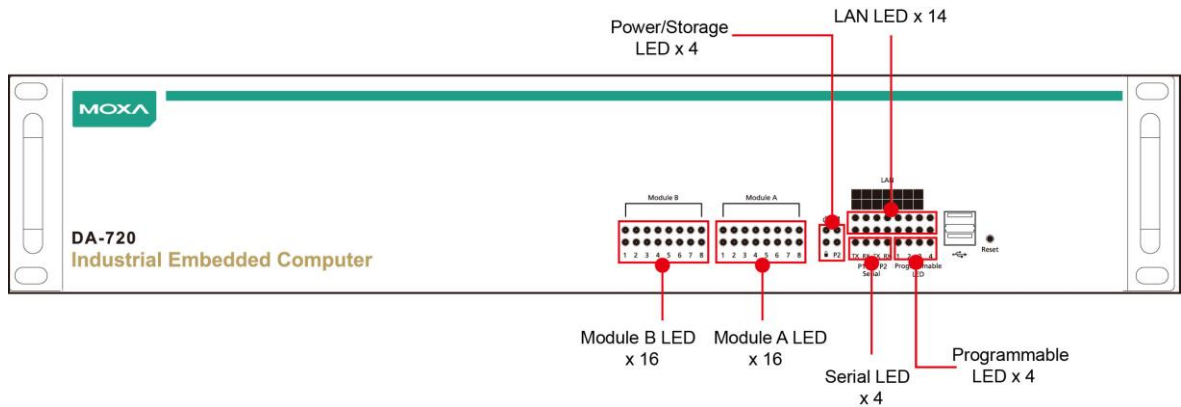

LED	Color	Description
Power	Green	Power is on
	Off	No power input
Storage	Yellow/Blinking	Data is being written to or to read from the storage unit
	Off	Storage unit is idle
Power Input 1 Status	Red	Power Input 1 has failed
	Off	Power is being properly supplied to Power Input 1
Power Input 2 Status	Red	Power Input 2 has failed
	Off	Power is being properly supplied to Power Input 2
Gigabit Ethernet LEDs 1-14	Green	Ethernet link is up
	Blinking	Ethernet is transmitting or receiving data
	Off	No connection
Serial Port TX 1-2	Green / Blinking	Serial port is transmitting data
	Off	No operation on the serial TX ports
Serial Port RX 1-2	Yellow / Blinking	Serial port is receiving data
	Off	No operation on the serial RX ports
Programmable 1-4	Green	As defined by the user

Connecting to a Display

The DA-720-DPP embedded computer comes with a D-Sub 15-pin female connector to connect to a VGA monitor and a DVI-D connector for DVI output. Turn off the power source to the computer before you connect or disconnect the monitor cable.

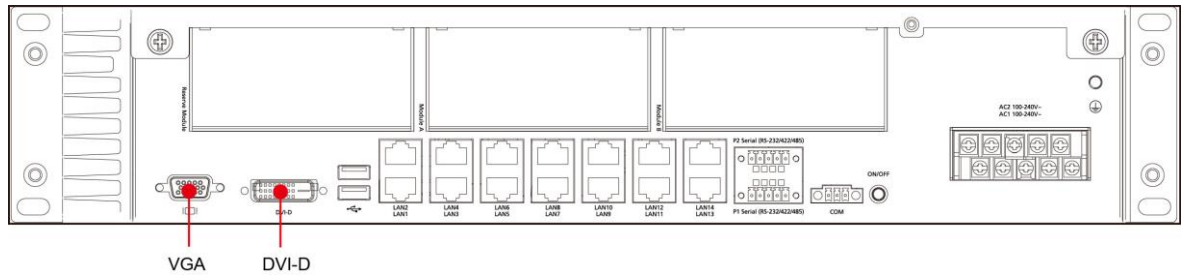

DVI-D	VGA																																																																																		
	<p>DB15 Female Connector</p>																																																																																		
<table border="1" style="width: 100%; border-collapse: collapse;"> <thead> <tr style="background-color: #cccccc;"> <th style="width: 15%;">Pin No.</th> <th style="width: 85%;">DVI-D</th> </tr> </thead> <tbody> <tr><td>1</td><td>TMDS Data 2 -</td></tr> <tr><td>2</td><td>TMDS Data 2 +</td></tr> <tr><td>3</td><td>TMDS Data 2/4 shield</td></tr> <tr><td>4</td><td>TMDS Data 4 -</td></tr> <tr><td>5</td><td>TMDS Data 4 +</td></tr> <tr><td>6</td><td>DDC clock (SCL)</td></tr> <tr><td>7</td><td>DDC data (SDA)</td></tr> <tr><td>8</td><td>Unused</td></tr> <tr><td>9</td><td>TMDS Data 1 -</td></tr> <tr><td>10</td><td>TMDS Data 1 +</td></tr> <tr><td>11</td><td>TMDS Data 1/3 shield</td></tr> <tr><td>12</td><td>TMDS Data 3 -</td></tr> <tr><td>13</td><td>TMDS Data 3 +</td></tr> <tr><td>14</td><td>+5 VDC</td></tr> <tr><td>15</td><td>Ground</td></tr> <tr><td>16</td><td>Hot plug detect</td></tr> <tr><td>17</td><td>TMDS Data 0 -</td></tr> <tr><td>18</td><td>TMDS Data 0 +</td></tr> <tr><td>19</td><td>TMDS Data 0/5 shield</td></tr> <tr><td>20</td><td>TMDS Data 5 -</td></tr> <tr><td>21</td><td>TMDS Data 5 +</td></tr> <tr><td>22</td><td>TMDS Clock shield</td></tr> <tr><td>23</td><td>TMDS Clock +</td></tr> <tr><td>24</td><td>TMDS Clock -</td></tr> </tbody> </table>	Pin No.	DVI-D	1	TMDS Data 2 -	2	TMDS Data 2 +	3	TMDS Data 2/4 shield	4	TMDS Data 4 -	5	TMDS Data 4 +	6	DDC clock (SCL)	7	DDC data (SDA)	8	Unused	9	TMDS Data 1 -	10	TMDS Data 1 +	11	TMDS Data 1/3 shield	12	TMDS Data 3 -	13	TMDS Data 3 +	14	+5 VDC	15	Ground	16	Hot plug detect	17	TMDS Data 0 -	18	TMDS Data 0 +	19	TMDS Data 0/5 shield	20	TMDS Data 5 -	21	TMDS Data 5 +	22	TMDS Clock shield	23	TMDS Clock +	24	TMDS Clock -	<table border="1" style="width: 100%; border-collapse: collapse;"> <thead> <tr style="background-color: #cccccc;"> <th style="width: 15%;">Pin No.</th> <th style="width: 85%;">Signal Definition</th> </tr> </thead> <tbody> <tr><td>1</td><td>RED</td></tr> <tr><td>2</td><td>GREEN</td></tr> <tr><td>3</td><td>BLUE</td></tr> <tr><td>4</td><td>-</td></tr> <tr><td>5</td><td>GND</td></tr> <tr><td>6</td><td>GND</td></tr> <tr><td>7</td><td>GND</td></tr> <tr><td>8</td><td>GND</td></tr> <tr><td>9</td><td>-</td></tr> <tr><td>10</td><td>GND</td></tr> <tr><td>11</td><td>-</td></tr> <tr><td>12</td><td>-</td></tr> <tr><td>13</td><td>H-Sync</td></tr> <tr><td>14</td><td>V-Sync</td></tr> <tr><td>15</td><td>-</td></tr> </tbody> </table>	Pin No.	Signal Definition	1	RED	2	GREEN	3	BLUE	4	-	5	GND	6	GND	7	GND	8	GND	9	-	10	GND	11	-	12	-	13	H-Sync	14	V-Sync	15	-
Pin No.	DVI-D																																																																																		
1	TMDS Data 2 -																																																																																		
2	TMDS Data 2 +																																																																																		
3	TMDS Data 2/4 shield																																																																																		
4	TMDS Data 4 -																																																																																		
5	TMDS Data 4 +																																																																																		
6	DDC clock (SCL)																																																																																		
7	DDC data (SDA)																																																																																		
8	Unused																																																																																		
9	TMDS Data 1 -																																																																																		
10	TMDS Data 1 +																																																																																		
11	TMDS Data 1/3 shield																																																																																		
12	TMDS Data 3 -																																																																																		
13	TMDS Data 3 +																																																																																		
14	+5 VDC																																																																																		
15	Ground																																																																																		
16	Hot plug detect																																																																																		
17	TMDS Data 0 -																																																																																		
18	TMDS Data 0 +																																																																																		
19	TMDS Data 0/5 shield																																																																																		
20	TMDS Data 5 -																																																																																		
21	TMDS Data 5 +																																																																																		
22	TMDS Clock shield																																																																																		
23	TMDS Clock +																																																																																		
24	TMDS Clock -																																																																																		
Pin No.	Signal Definition																																																																																		
1	RED																																																																																		
2	GREEN																																																																																		
3	BLUE																																																																																		
4	-																																																																																		
5	GND																																																																																		
6	GND																																																																																		
7	GND																																																																																		
8	GND																																																																																		
9	-																																																																																		
10	GND																																																																																		
11	-																																																																																		
12	-																																																																																		
13	H-Sync																																																																																		
14	V-Sync																																																																																		
15	-																																																																																		

Connecting USB Devices

The DA-720-DPP embedded computer has four USB ports; two USB 2.0 ports on the front panel and two USB 3.0 ports on the rear panel. All of the ports support Plug & Play and hot plugging of USB devices. These ports can be used to connect USB devices, such as a keyboard, mouse, USB flash disk, and USB CD-ROM. In addition, both USB ports support system boot up, which can be activated by modifying the BIOS settings. Refer to Chapter 3 "BIOS Setup" for the configuration process.

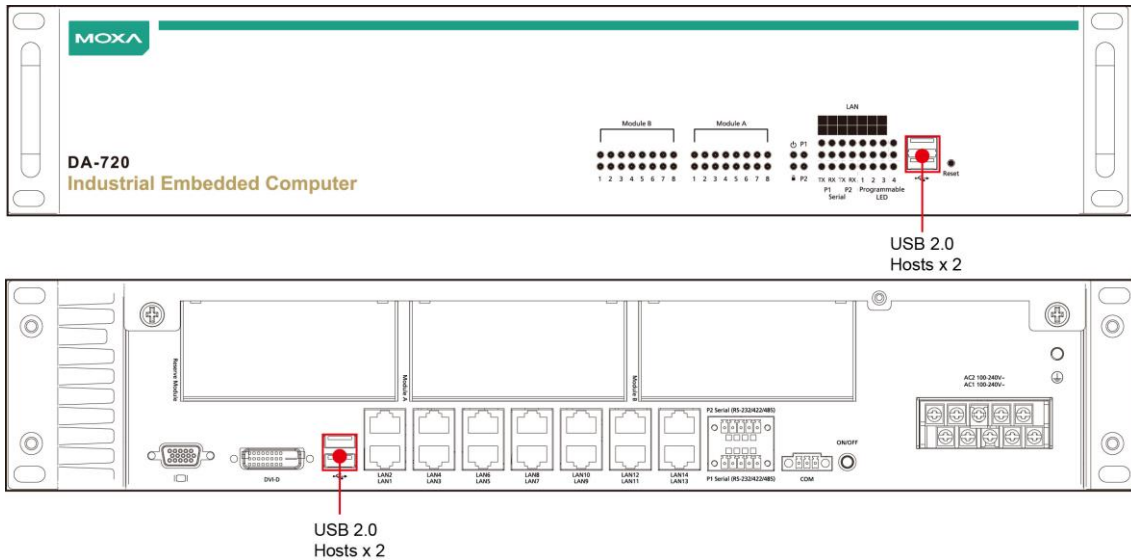

Gigabit LAN Ports

The DA-720-DPP Basic System has 14 Gigabit LAN ports. When the cable is properly connected, the LEDs on the RJ45 connectors will glow to indicate a connection.

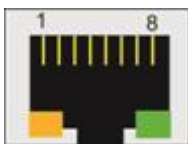
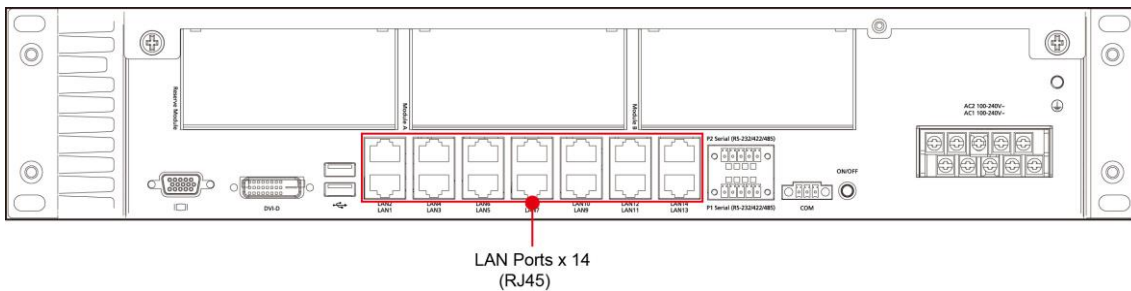

Pin	10/100 Mbps	1000 Mbps
1	Tx+	TRD(0)+
2	Tx-	TRD(0)-
3	Rx+	TRD(1)+
4	-	TRD(2)+
5	-	TRD(2)-
6	Rx-	TRD(1)-
7	-	TRD(3)+
8	-	TRD(3)-

LED	Color	Description
Gigabit Ethernet LEDs 1-14	Green	Ethernet is Link
	Blinking	Ethernet is transmitting or receiving data
	Off	No connection

The default IP addresses and netmasks of the Gigabit LAN ports are as follows:

	Default IP Address	Netmask
LAN 1	192.168.3.127	255.255.255.0
LAN 2	192.168.4.127	255.255.255.0
LAN 3	192.168.5.127	255.255.255.0
LAN 4	192.168.6.127	255.255.255.0
LAN 5	192.168.7.127	255.255.255.0
LAN 6	192.168.8.127	255.255.255.0
LAN 7	192.168.9.127	255.255.255.0
LAN 8	192.168.10.127	255.255.255.0
LAN 9	192.168.11.127	255.255.255.0
LAN 10	192.168.12.127	255.255.255.0
LAN 11	192.168.13.127	255.255.255.0
LAN 12	192.168.14.127	255.255.255.0
LAN 13	192.168.15.127	255.255.255.0
LAN 14	192.168.16.127	255.255.255.0

NOTE The Windows 7E and Windows 10 models use DHCP for IP address assignment.

Connecting a Serial Device

The DA-720 has two 3-in-1 RS/232/422/485 serial ports. When the cable is properly connected, the LEDs on the front panel will glow to indicate the same.

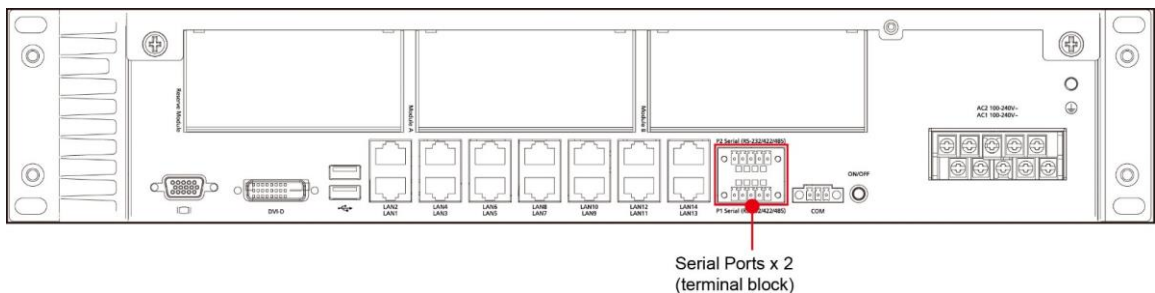

Pin Assignment

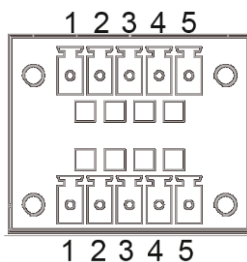

Pin	RS-232	RS-485(4W)	RS-485(2W)	RS-422
1	TxD	TxD+	-	TxD+
2	RxD	TxD-	-	TxD-
3	RTS	RxD+	Data+	RxD+
4	CTS	RxD-	Data-	RxD-
5	GND	GND	GND	GND

Serial LED

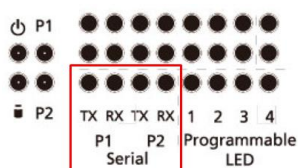

LED	Color	Description
Serial Port TX 1-2	Green/Blinking	Serial port is transmitting data
	Off	No operation on the serial TX ports
Serial Port RX 1-2	Green/Blinking	Serial port is receiving data
	Off	No operation on the serial RX ports

Connecting a Relay Device

The DA-720 has one built-in relay for visual/audio alarm as shown in the diagram below:

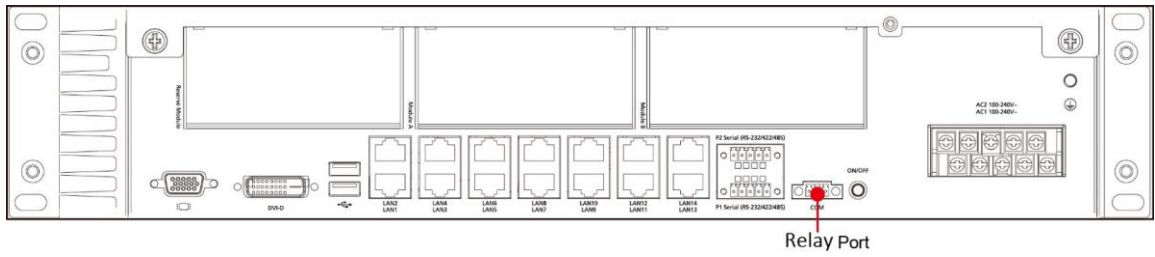

Pin Assignment

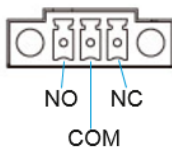

Pin	Description
NO	Normally open contact
COM	COM pin
NC	Normally closed contact

Upgrading the Memory Module

The DA-720-DPP embedded computer supports 2 DDR4 2133 MHz SODIMM slots with up to 32-GB capacity. To install a SDRAM memory module or replace an existing one, do the following:

1. Disconnect the DA-720-DPP from its power source.
2. Unfasten the screws on the back of the computer, and then remove the upper cover.



3. Find the location of the SDRAM memory socket.

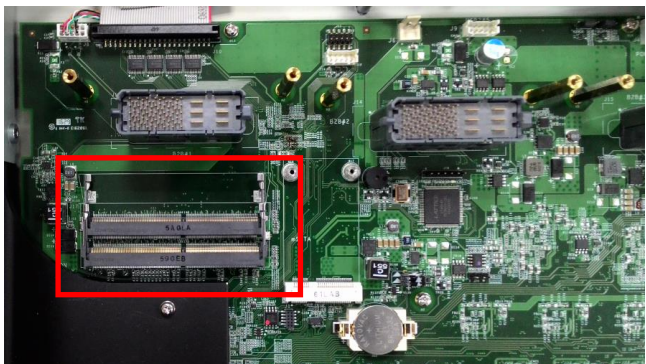

4. Push the two clutches of the socket and remove the existing memory module. Insert the new memory module into the socket in the correct direction and push down the memory module until the clutches have been securely fastened.



5. When finished, replace the upper cover of the computer, replace the screws, and fasten the screws to secure the cover.

Installing a mSATA Card

The DA-720-DPP embedded computer comes with an mSATA socket. To insert an mSATA card into the socket, do the following:

1. Disconnect the DA-720-DPP from its power source.
2. Use a screwdriver to remove all the screws on the top cover of the DA-720-DPP to expose the main board.
3. Find the mSATA socket, which is located in the middle of the main board.

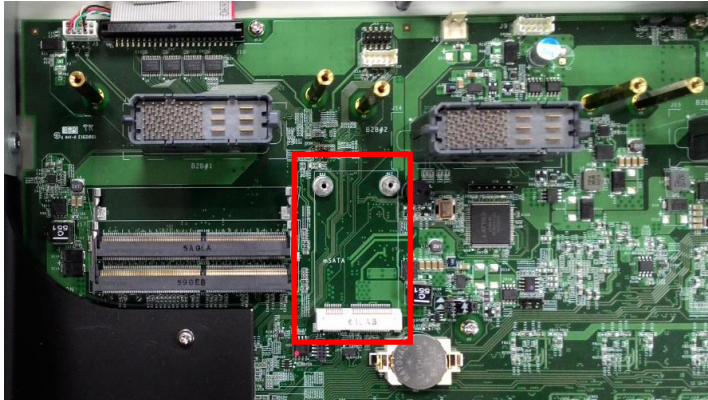

4. Insert the mSATA card into the socket and push downwards until the card is firmly inserted into the slot. Tighten the screws on the mSATA module.

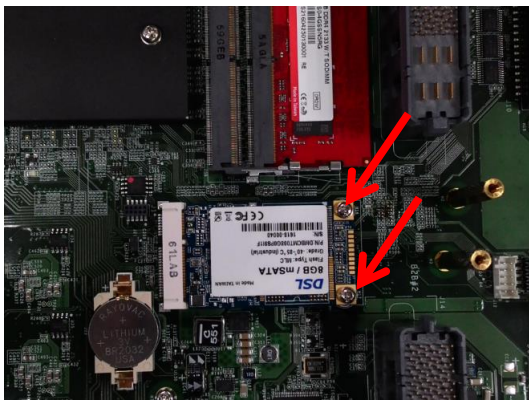
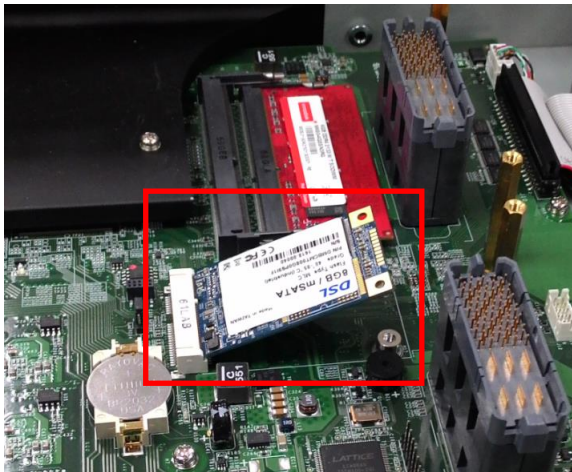
**ATTENTION**

You must disconnect or remove the power source before inserting or removing CompactFlash cards. The DA-720-DPP rackmount computer does not support hot plugging and Plug and Play of CompactFlash cards.

Installing SATA Hard Disk/Solid-state Disk

The DA-720-DPP embedded computer has one SATA connector for installing a SATA hard disk / Solid State Disk. To install a 2.5-inch SATA hard disk / Solid State Disk, do the following:

1. Disconnect the DA-720-DPP from its power source.
2. Open the top cover of the DA-720-DPP.
3. The hard disk bracket should be installed on the top left side of the DA-720-DPP.

Note: The hard disk bracket is an optional accessory that can be purchased separately.

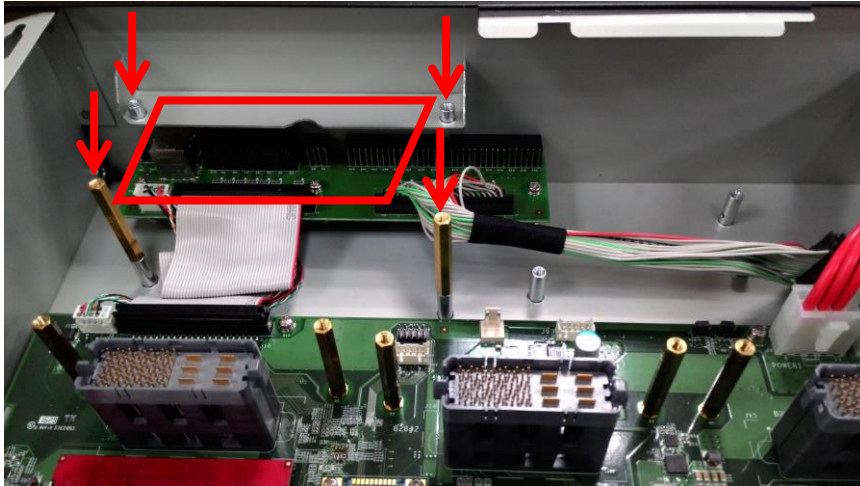

4. Install the SATA hard disk/ Solid State Disk in the hard disk bracket.



5. Connect the SATA HDD/SSD signal cable to the computer.

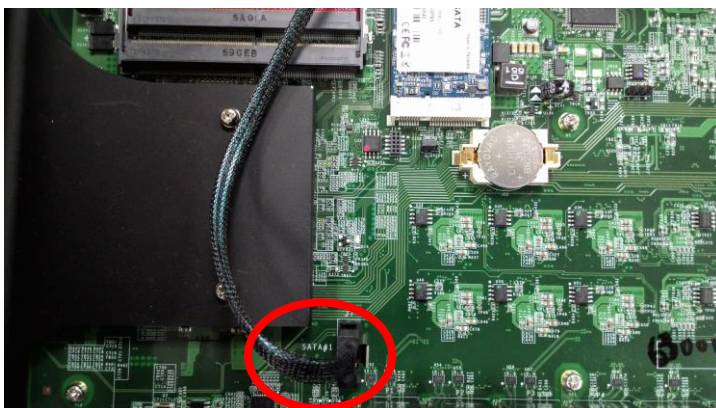

6. Connect the SATA power cable to the computer.

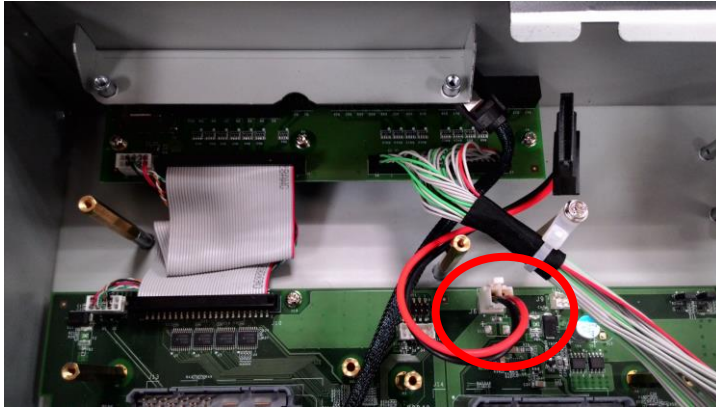

7. Install the SATA hard disk/ Solid State Disk and bracket inside the DA-720-DPP and tighten the screws to secure the disk and its bracket.



8. Connect the SATA cable and power cable to hard disk/ Solid State Disk

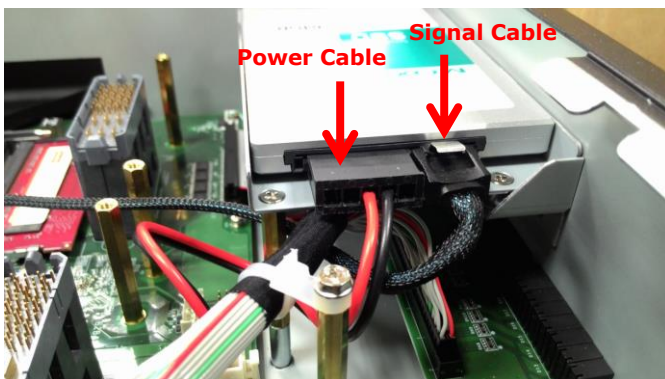
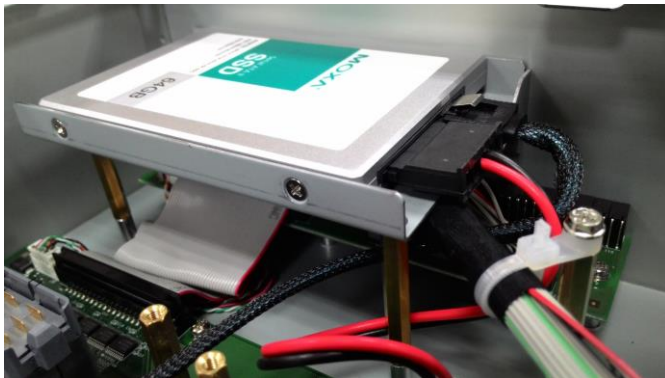

Installing and Removing Expansion Modules

The DA-720-DPP embedded computer has three slots and two of them are for DE expansion modules.



Expansion Module	Description	Reserve Slot	Module Slot A	Module Slot B
DE-LN04-RJ	4-port 100/1000 Mbps PCIe LAN module	N/A (Bandwidth Limitation)	✓	N/A (Bandwidth Limitation)
DE-LN08-RJ	8-port 100/1000 Mbps PCIe LAN module	N/A (Bandwidth Limitation)	✓	N/A (Bandwidth Limitation)
DE-2-SATA	2x 2.5" SATA III SSD/HDD socket Module	✓	✓	N/A (Heat Limitation)
DE-PRP-HSR-EF	2-Port 100/1000 Mbps PCIe PRP/HSR LAN module	✓	✓	N/A (Heat Limitation)
DE-SP08-I-TB	8-port RS-232/422/485 PCIe serial module	✓	✓	✓
DE-2-IRIGB-4-DI/DO	2-port IRIG-B signal input module with 4 digital inputs, 4 digital outputs	✓	✓	✓

To install or remove expansion modules, do the following:

1. Disconnect the DA-720-DPP from the power source.
2. Unfasten the thumbscrews locking the top cover of DA-720-DPP.
3. Unfasten the two screws locking the covers of the expansion module A or module B on the rear panel.

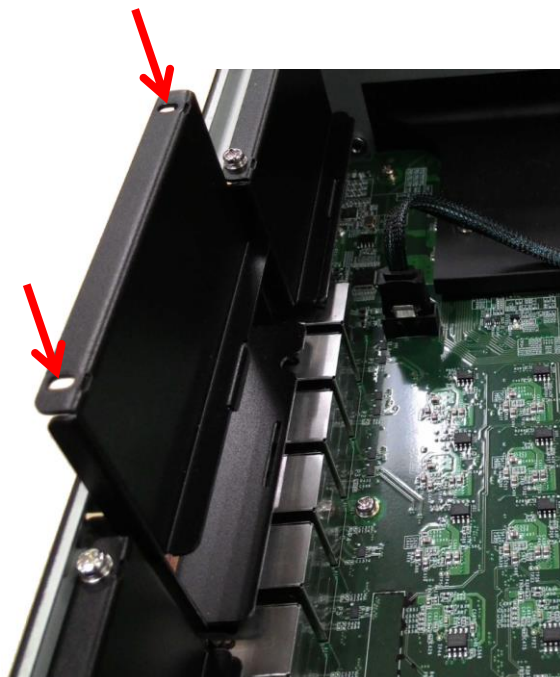

4. Insert or remove the expansion module by carefully pushing or pulling on the expansion module. Be certain to apply pressure evenly across the board to ensure that the board is not damaged.

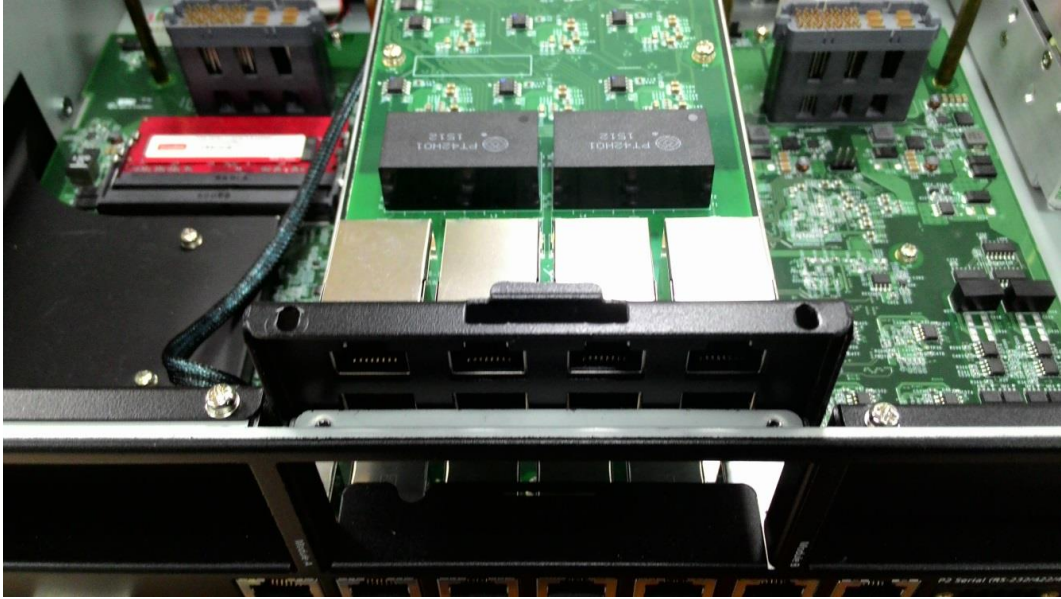

5. Tighten the four screws on the expansion module to lock it in place.

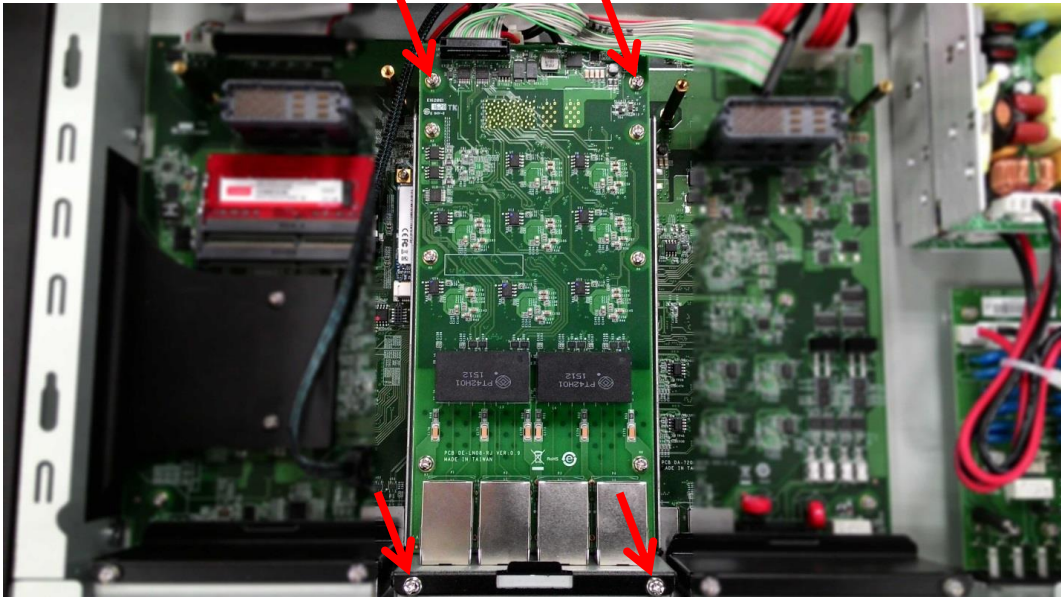

- 6. Connect the data cable to the module.

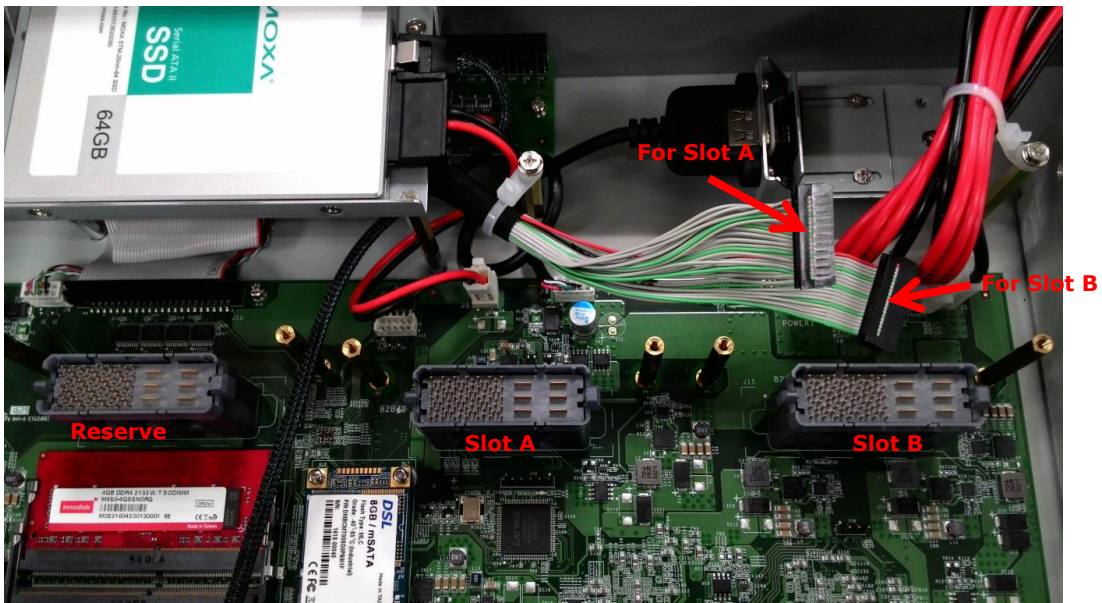
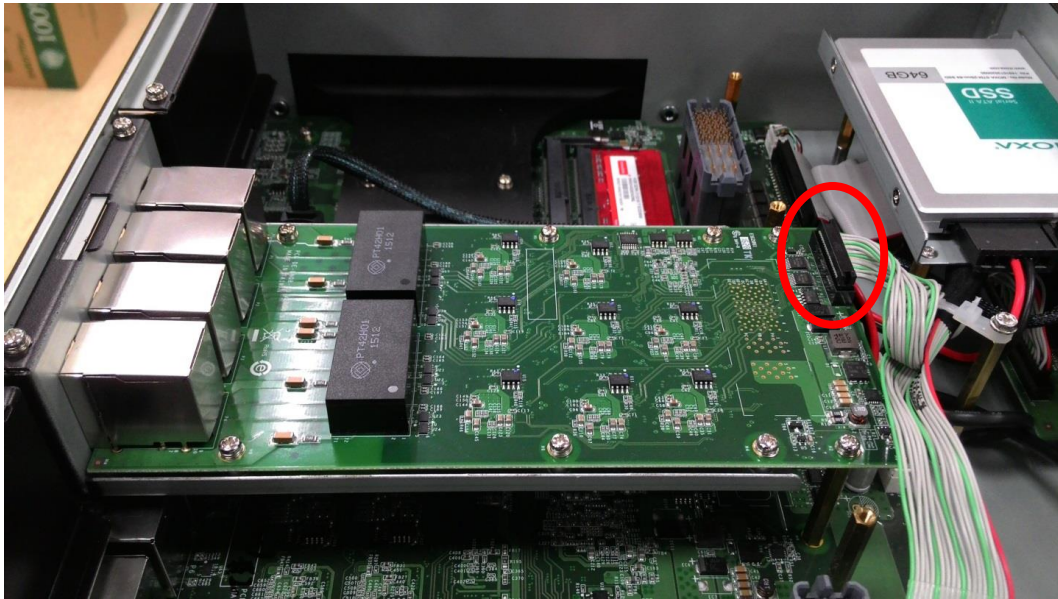

DE-SP08-I-TB Serial Expansion Modules

The DE-SP08-I-DB serial expansion modules have 8 software-selectable serial ports that are provided with terminal block connectors. The DE-SP08-I-DB supports 2 kV isolation protection for all signals. In addition, the DA-SP08-I-EMC4-DB is able to withstand EMC level 4 interference. Each port can be configured by software for RS-232, RS-422, or RS-485 communication.

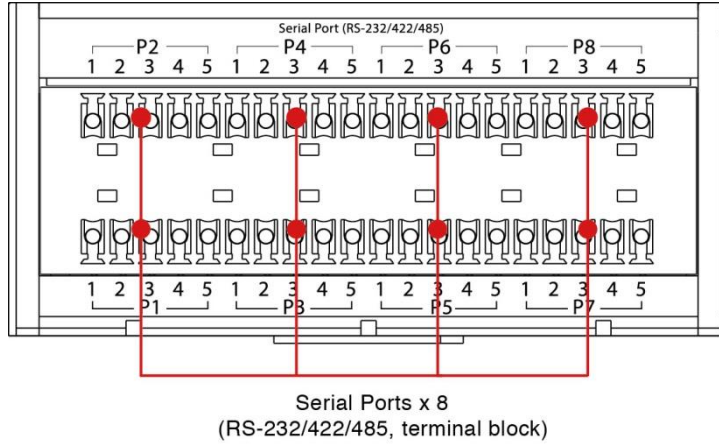

The pin assignments for the ports are shown in the following table:

	RS-232	RS-422	RS-485
1	TXD	TXD+	-
2	RXD	TXD-	-
3	RTS	RXD+	DATA+
4	CTS	RXD-	DATA-
5	GND	GND	GND

Front Panel LEDs	LED	Color	Description
TX 	TX 1-8	Green	The serial port is transmitting data
		Off	No operation on the serial port
RX 	RX 1-8	Yellow	The serial port is receiving data
		Off	No operation on the serial port

DE-LN08-RJ/DE-LN04-RJ Ethernet Expansion Modules

The DE-LN08-RJ and DE-LN04-RJ Ethernet expansion modules have 8 and 4 Giga bps LAN ports with terminal block connectors. The DE-LN08-RJ and DE-LN04-RJ support 1.5 kV magnetic Isolation Protection for all signals.

NOTE The DE-LN08-RJ/ DE-LN04-RJ can only be used in slot A.

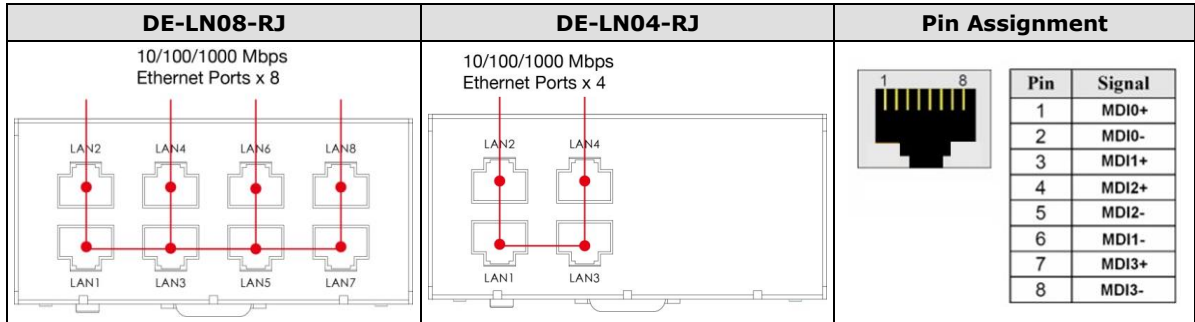

Front Panel LEDs	Color	Description
100 Mbps	Green	100 Mbps Ethernet mode
1000 Mbps	Yellow	1000 Mbps Ethernet mode
	Blinking	Ethernet link is transmitting or receiving data
	Off	No connection

DE-PRP-HSR-EF Ethernet Redundancy Expansion Modules

The DE-PRP-HSR-EF Ethernet Redundancy expansion module is compliant with the latest standardized redundancy protocols for industrial automation networks, such as IEC 62439-3 Clause 4 (Parallel Redundancy Protocol, PRP) and IEC 62439-3 Clause 5 (High availability Seamless Redundancy, HSR). PRP/HSR ensures high-availability of the system and data integrity for mission-critical applications in electrical substation and/or process automation systems that require zero-recovery-time redundancy. The DE-PRP-HSR-EF comes with two 10/100/1000BaseT(X) and 100/1000BaseSFP slot combo ports for PRP/HSR redundant protocol communications. Moxa’s DA-720 Series industrial computer coupled with the DA-PRP-HSR module is the ideal solution for power substation automation and for deploying in process automation systems.

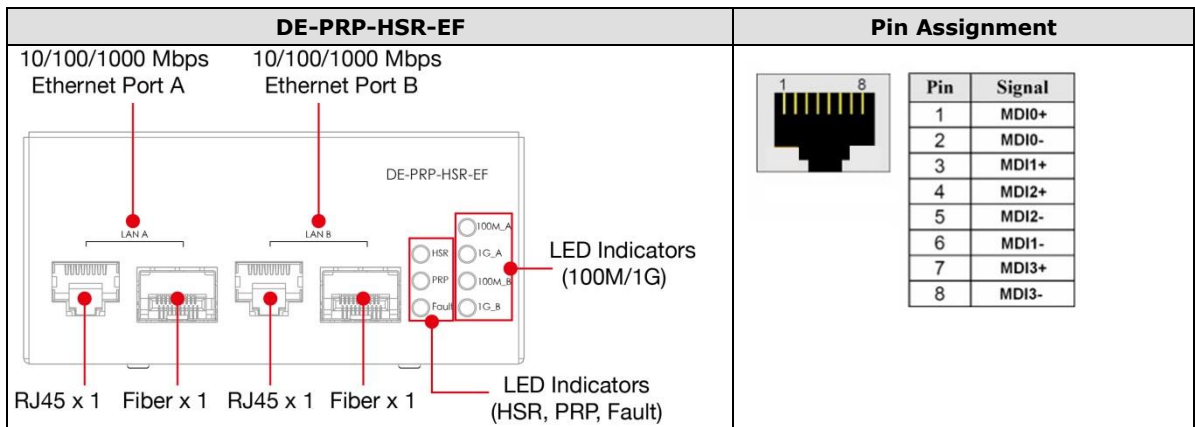

DE-PRP-HSR-EF Module LEDs	LED	Color	Description
	Fault	Red	LAN A or LAN B is not linked
	PRP	Yellow	The DE-PRP-HSR-EF module is in PRP Mode
	HSR	Green	The DE-PRP-HSR-EF module is in HSR Mode
	100M_A	Green	Linking / receiving or transmitting data on the LAN A 100M link
		Off	No link
	100M_B	Green	Linking / receiving or transmitting data on the LAN B 100M link
		Off	No link
	1G_A	Yellow	Linking / receiving or transmitting data on the LAN A 1G link
		Off	No link
	1G_B	Yellow	Linking / receiving or transmitting data on the LAN B 1G link
		Off	No link

DA-720 Front Panel LED	LED	Color	Description
	Fault	Yellow	LAN A or LAN B is not linked
	PRP	Green	The DE-PRP-HSR-EF module is in PRP Mode
	HSR	Yellow	The DE-PRP-HSR-EF module is in HSR Mode
	100M_A	Green	Linking / receiving or transmitting data on the LAN A 100M link
		Off	No link
	100M_B	Green	Linking / receiving or transmitting data on the LAN B 100M link
		Off	No link
	1G_A	Yellow	Linking / receiving or transmitting data on the LAN A 1G link
		Off	No link
	1G_B	Yellow	Linking / receiving or transmitting data on the LAN B 1G link
		Off	No link

DE-2-SATA—2.5” Hot-pluggable HDD/SSD Expansion Modules

The DE-2-SATA has two 2.5-inch SATA slots for installing a SATA hard disk or a SSD. The DE-2-SATA modules are designed for:

- Easy installation: Support Hot-plugging
- Data redundancy: Support software RAID 0,1
- Self-diagnostics: Support user-defined alerts for storage usage

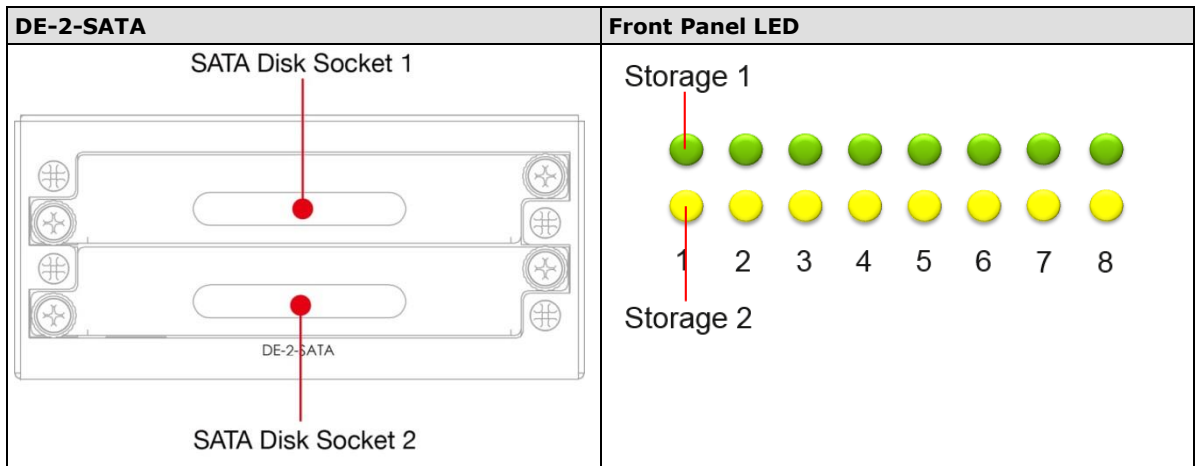

Front Panel LED	Color	Description
Storage 1	Green/Blinking	Data is being written to or read from the storage unit
	Off	Storage unit is idle
Storage 2	Yellow/Blinking	Data is being written to or read from the storage unit
	Off	Storage unit is idle

DE-2-IRIGB-4-DI/DO Time-synchronization Expansion Modules

The time-synchronization module features 4 digital inputs and 4 digital outputs and provides precision timing information using IRIG-B input signals. All modules are designed to offer the greatest flexibility for setting up industrial applications and performing various tasks, specifically, users can swap out modules quickly and easily.

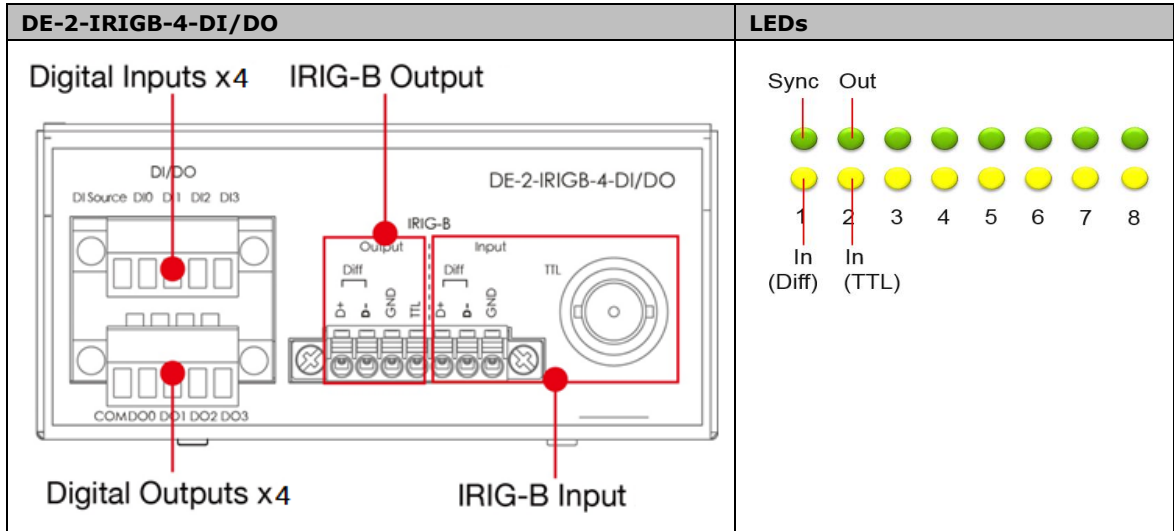

The LEDs on the front panel indicate the status as per the following table:

Front Panel LED	Color	Behavior	Description
Sync	Green	Steady on	Time is synchronized
		Off	Time is not synchronized
Out	Green	Blinking	Transmitting data
		Off	No operation
In (Diff)	Yellow	Blinking	Receiving data
		Off	No operation
In (TTL)	Yellow	Blinking	Receiving data
		Off	No operation

The pin assignment and the wiring diagram for the module is as indicated in the following diagrams.

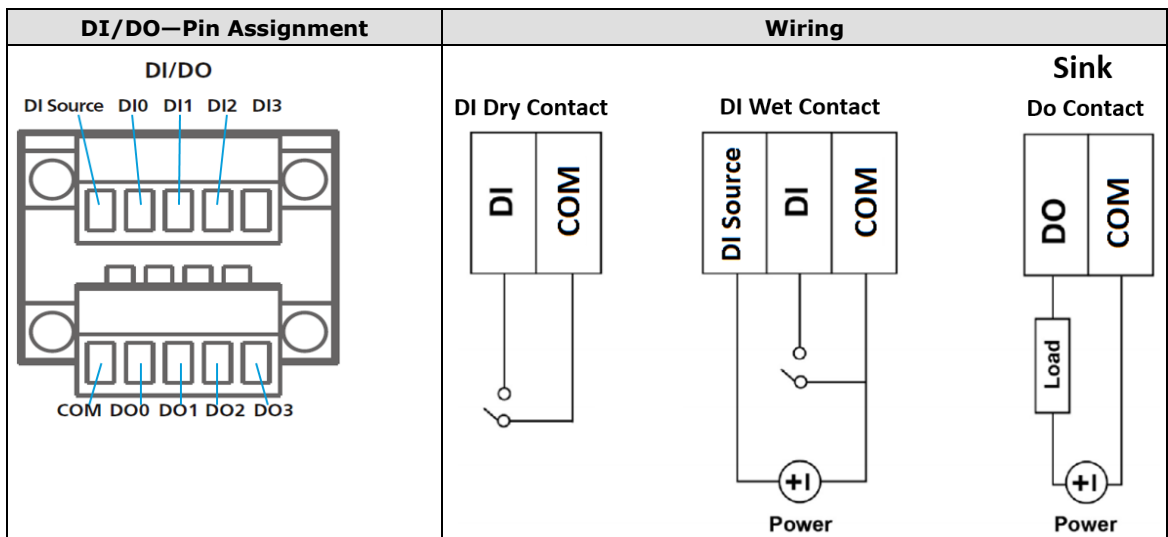

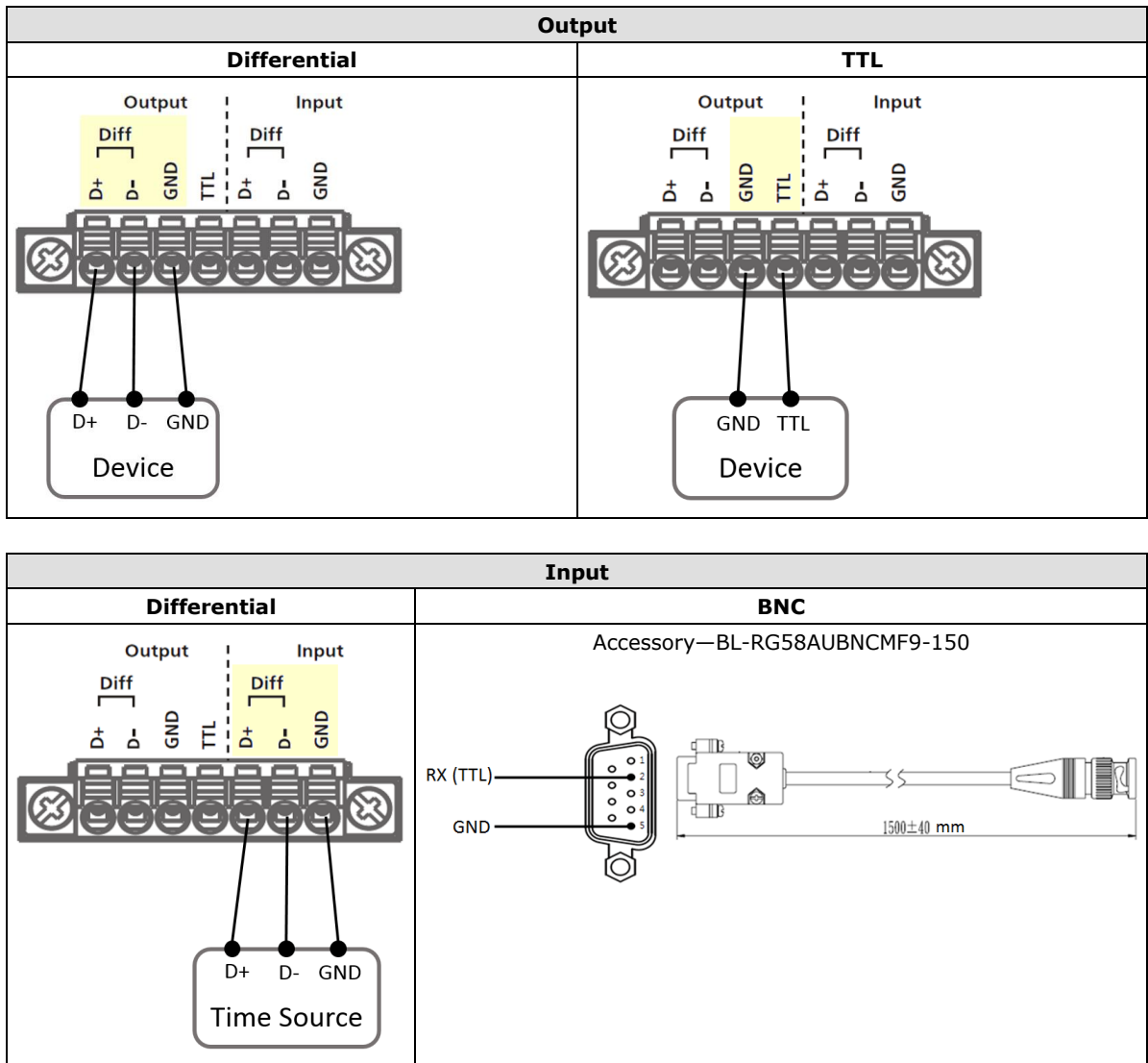

Installing a USB Dongle Kit

An optional USB-dongle kit can be purchased separately for the DA-720-DPP embedded computer that can help you secure the USB dongle inside the computer. To install the USB dongle with the USB dongle kit, do the following:

1. Disconnect the DA-720-DPP from its power source.
2. Open the top cover of the DA-720-DPP.
3. Connect the USB cable to the dongle bracket



4. Install the USB dongle kit in the middle section of the DA-720-DPP close to the power module. Make sure the screws are firmly attached and connect the USB cable of the USB dongle kit to the computer.

NOTE The USB dongle kit is an optional accessory that can be purchased separately.

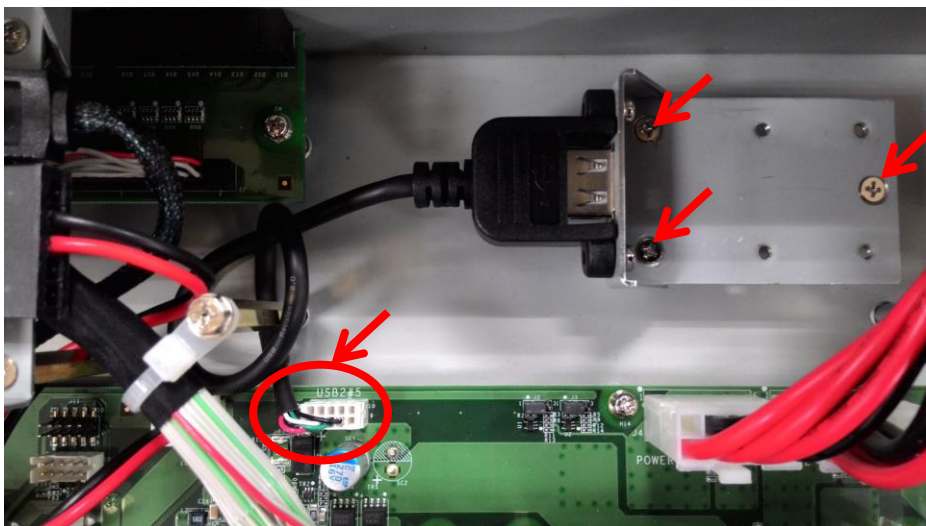
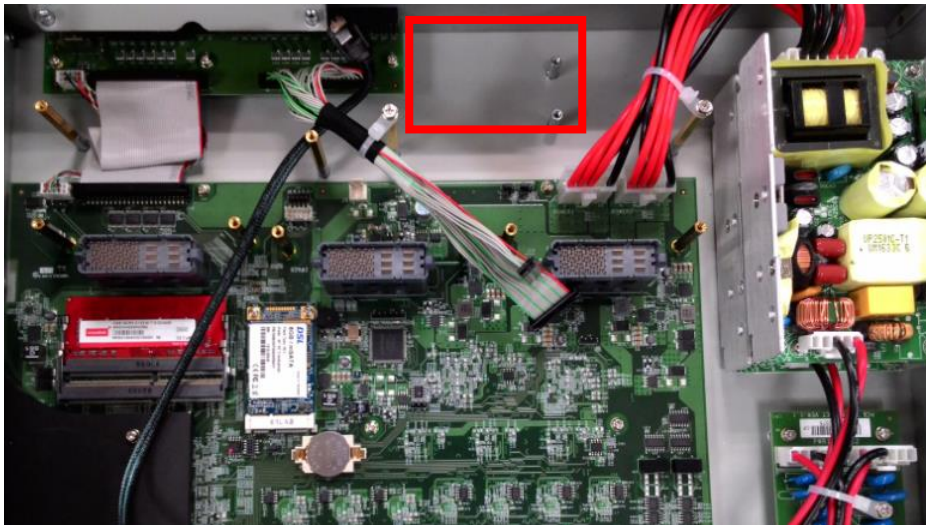

5. Install the USB Dongle in the Dongle bracket.

Mini sized dongle



Normal sized dongle



Gigabit Ethernet		USB Ports	
	Pin	Signal	<p>SuperSpeed standard A plug pinout</p>
	1	MDI0+	
	2	MDI0-	
	3	MDI1+	
	4	MDI2+	
	5	MDI2-	
	6	MDI1-	
	7	MDI3+	
	8	MDI3-	

BIOS Setup

This chapter describes the BIOS settings of the DA-720-DPP computer. The BIOS is a set of input/output control routines for peripherals. The BIOS is used to initialize system peripherals before the operating system is loaded. The BIOS setup allows the user to modify the system configurations of these peripherals' basic input/output.

The following topics are covered in this chapter:

❑ Entering the BIOS Setup

❑ Main Information

❑ Advanced Settings

- Boot Configuration
- SATA Configuration
- Internal Graphics Device
- Miscellaneous Configuration
- SIO ITE8768E
- Console Redirection
- Smart Recovery Info

❑ Security Settings

- Set Supervisor Password

❑ Power Settings

- Auto Wake on S5
- Wake on LAN

❑ Boot Settings

- Boot Type
- PXE Boot to LAN
- Add Boot Options
- Boot Delay Time
- Automatic Failover
- Boot Order Priority
- Legacy Normal Boot Menu
- Boot Type Order
- EFI

❑ Exit Settings

- Exit Saving Changes
- Save Change Without Exit
- Exit Discarding Changes
- Load Optimal Defaults
- Load Custom Defaults
- Save Custom Defaults
- Discard Changes

❑ Upgrading the BIOS

Entering the BIOS Setup

To enter the BIOS setup utility, press the "F2" key while the system is booting up. The main **BIOS Setup** screen is displayed. The following four options are available:

- Continue:** Continue to boot up
- Boot Manager:** Select the device for booting up
- Boot From File:** Select the UEFI boot-up file
- SCU:** Enter the BIOS configuration

Select **SCU** to enter the **BIOS configuration**.

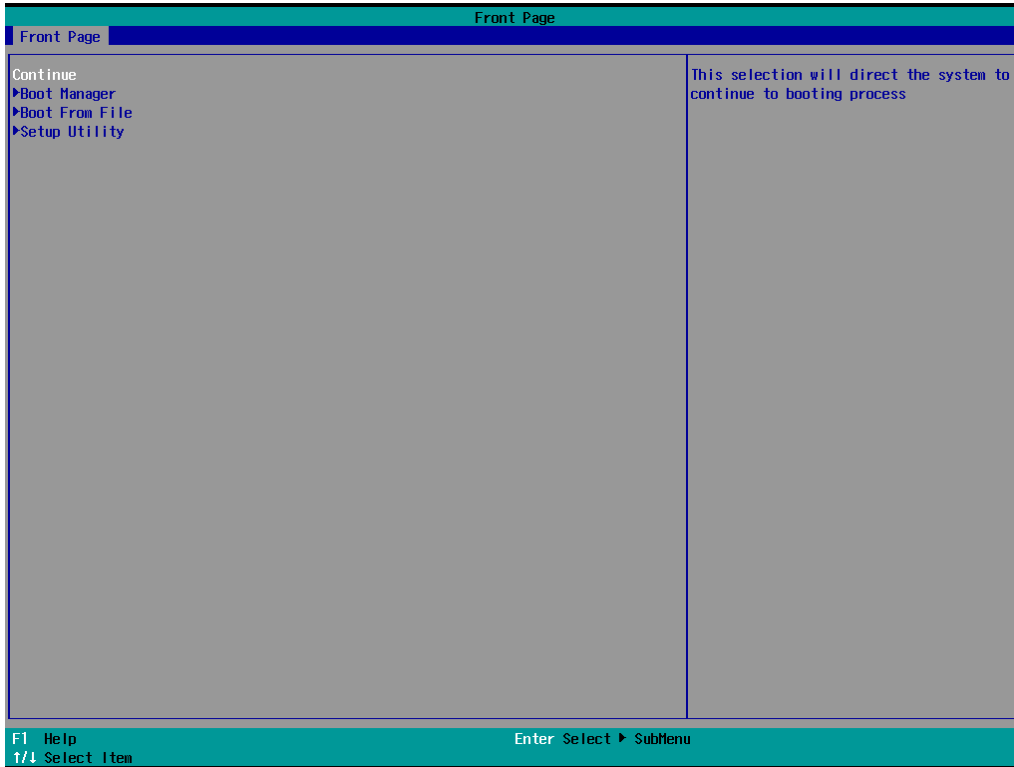

The following BIOS configuration screen will be shown when you enter SCU option:

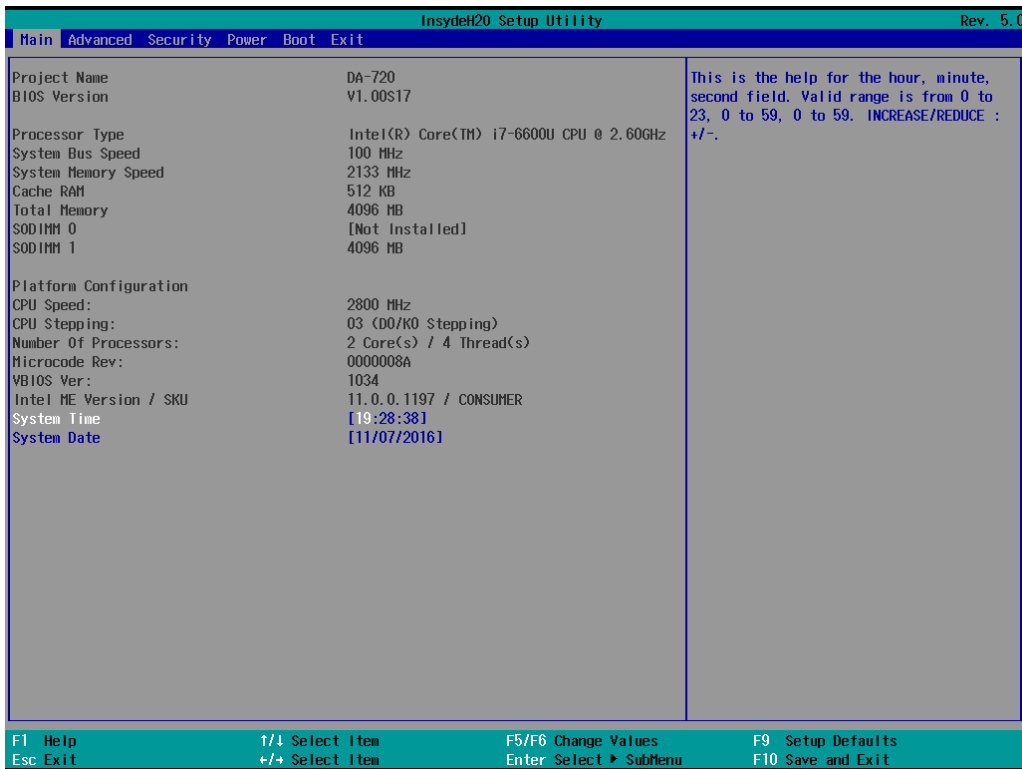

When you enter SCU, a basic description of each function key is listed at the bottom of the screen. Refer to these descriptions to learn how to use them.

- | | | | |
|---------------|-----------------------|---------------|---------------------------------|
| F1 | General Help | ↑ ↓ . | Select Item |
| F5/ F6 | Change Values | ← → | Select Menu |
| F9 | Setup Defaults | ESC | Exit |
| F10 | Save and Exit | EN TER | Select or go to Submenu. |

NOTE The information displayed for a **Processor Type** may vary depending on the computer model that you have purchased.

Main Information

The **Main** page indicates the system information, such as model name, BIOS version, and CPU type. You can view the basic system hardware information on this page.

Advanced Settings

The **Advanced** option displays configuration information on Boot, SATA, internal graphics device, SIO, and Smart Recovery feature.

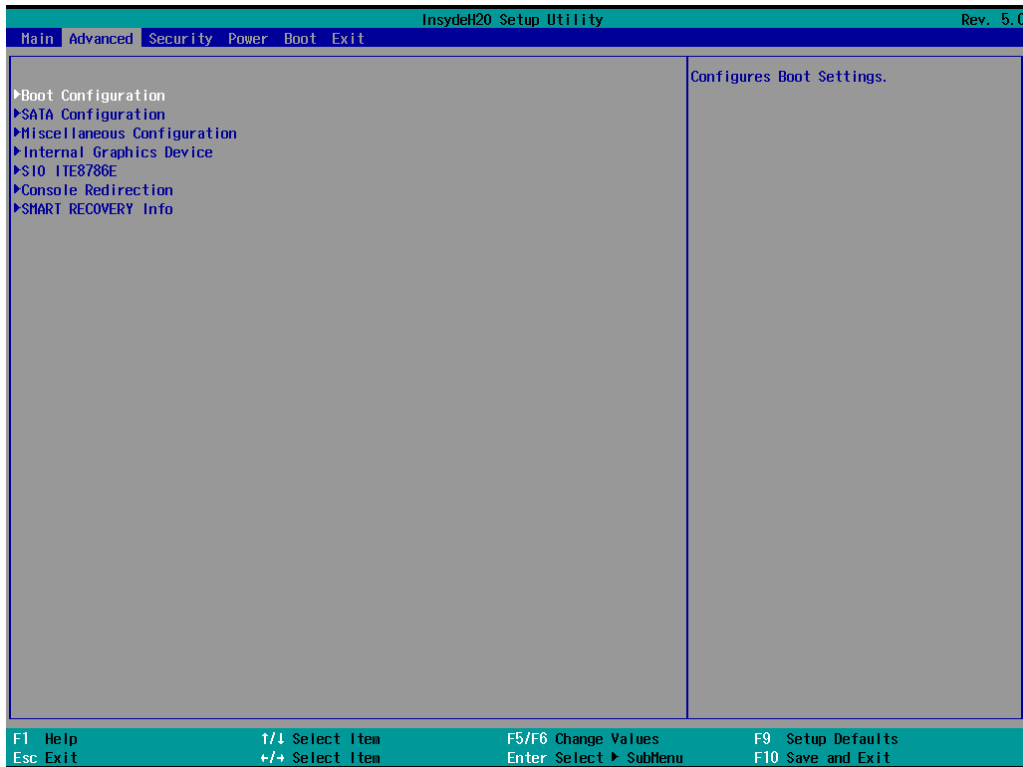

Boot Configuration

This feature allows you to configure a default setting for the keys on the number pad of the computer keyboard. Turning the **NumLock** on allows you to use the number keys to type out numbers and turning it off activates the key's other functions such as using the keypad as an arrow pad.

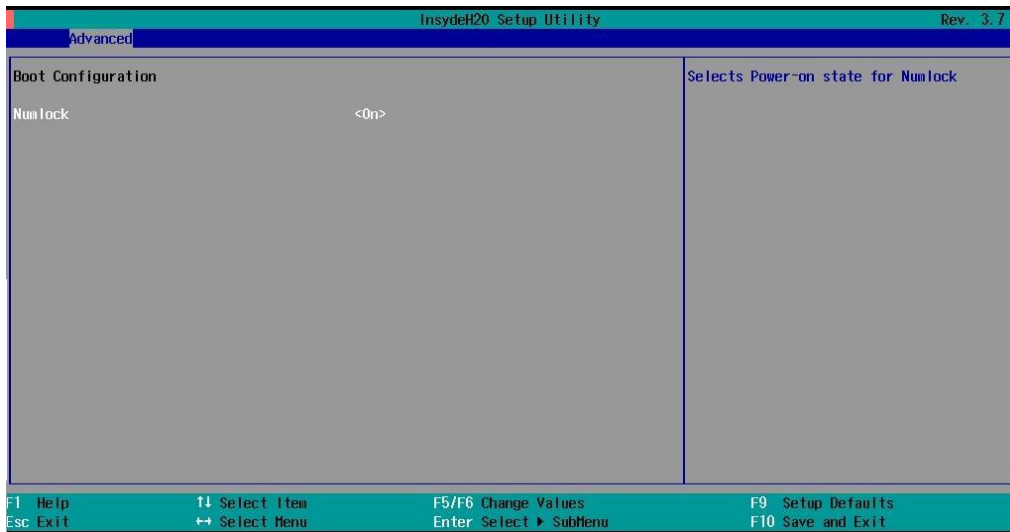

Option: On (default), Off.

SATA Configuration

The host drive controller can be configured for AHCI or RAID mode. When the AHCI mode is selected, the following screen is displayed:

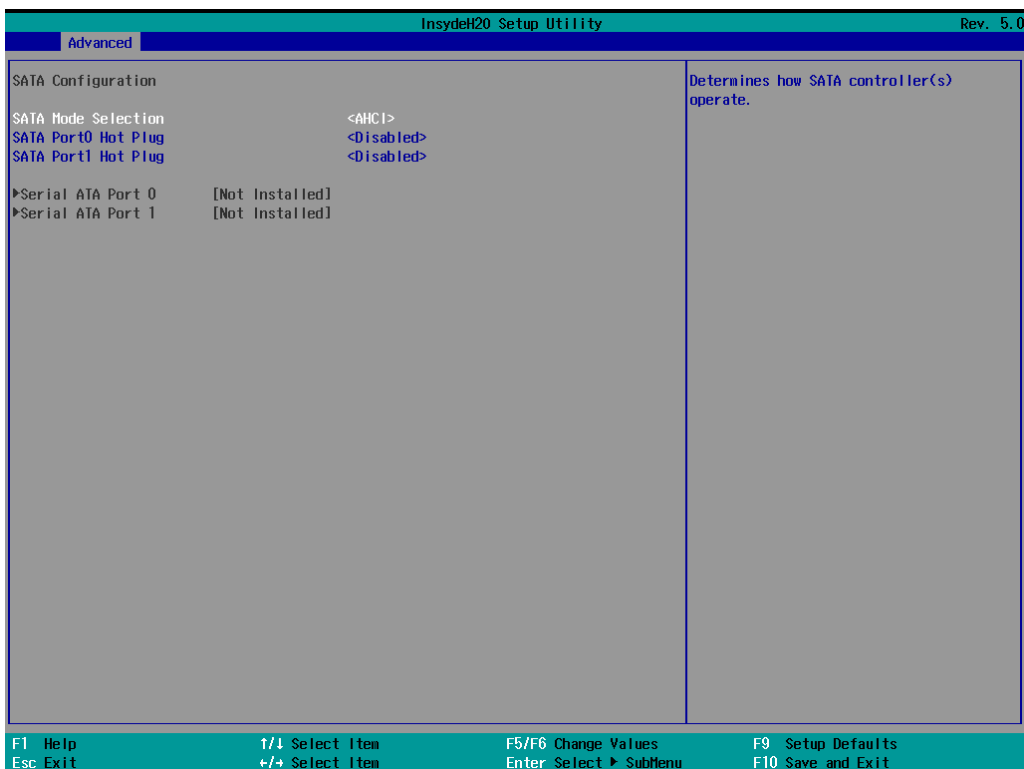

SATA Port 0 to 2 Hot Plug

This feature allows you to enable/disable hot plugging capabilities (the ability to remove the drive while the computer is running) for the storage drives installed on the system.

Options: Disable (default), Enabled

Internal Graphics Device

Allows you to enable/disable the internal graphics device.

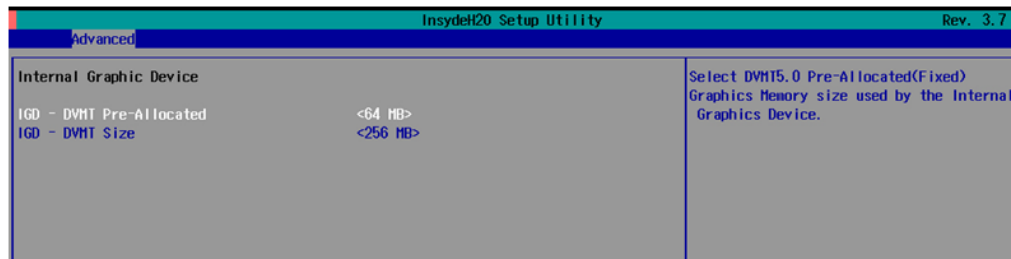

IGD—DVMT Pre-Allocated

Allows you to configure pre-allocated memory capacity for the IGD. Pre-allocated graphics memory is invisible to the operating system.

Options: 64 MB (default), 32 MB, 96 MB, 128 MB, 256 MB, 512 MB

DVMT is a BIOS solution where the optimum amount of memory is dynamically allocated and de-allocated as needed for balanced graphics and system performance, through Intel® Direct AGP and a highly efficient memory utilization scheme. DVMT ensures the most efficient use of available system memory resources for maximum 2D/3D graphics performance.

IGD—DVMT Size

Allows you to configure the maximum amount of memory DVMT will use when allocating additional memory for the internal graphics device.

Options: 256 MB (default), 128 MB, Max

Miscellaneous Configuration

Power ON after Power Failure

Allows you to enable/disable the automatic power up of your computer after a system crash.

Options: ON (default), OFF, Last State

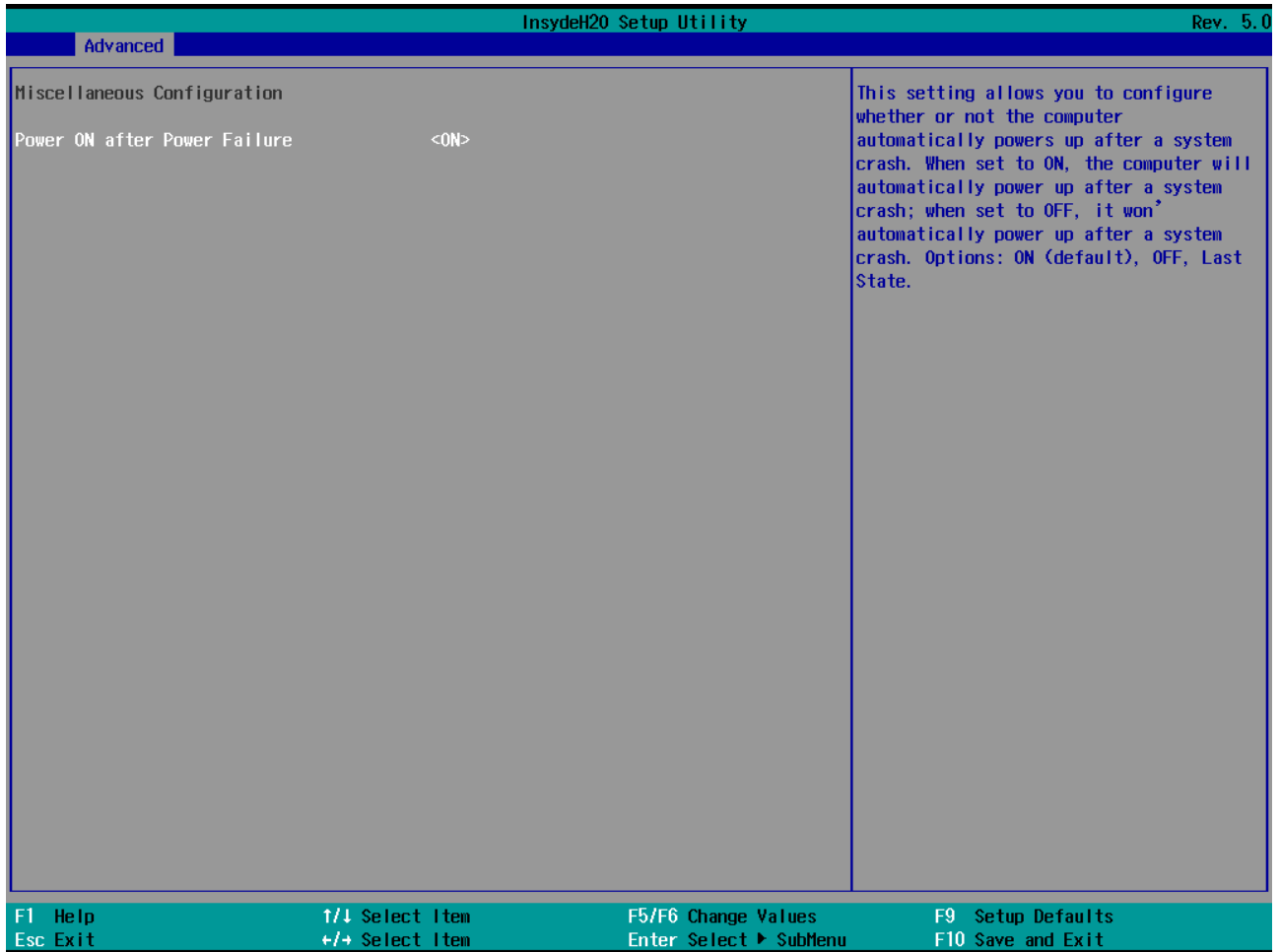

SIO ITE8768E

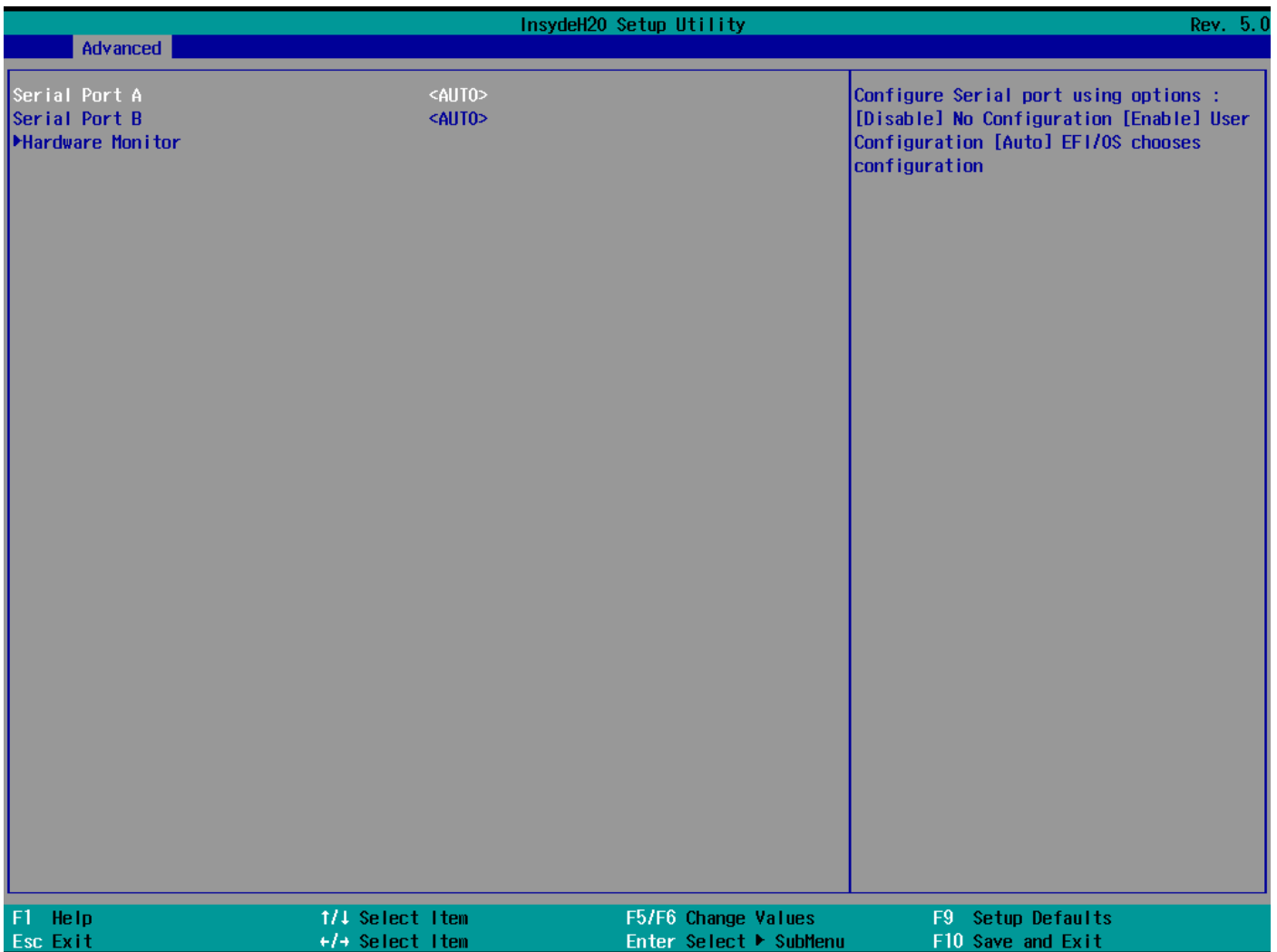

Serial Port A

Allows you to configure the serial port A.

Options:

- Auto (Default) The system chooses the configure for the resource
- Enable User configures the resource
- Disable Port is disabled and no configuration is possible

Serial Port B

Allows you to configure the serial port B.

Options:

- Auto (Default) The system chooses the configure for the resource
- Enable User configures the resource
- Disable Port is disabled and no configuration is possible

Hardware Monitor

This feature allows you to view hardware statistics like CPU and system temperature, voltage levels, and other chipset related information.

Console Redirection

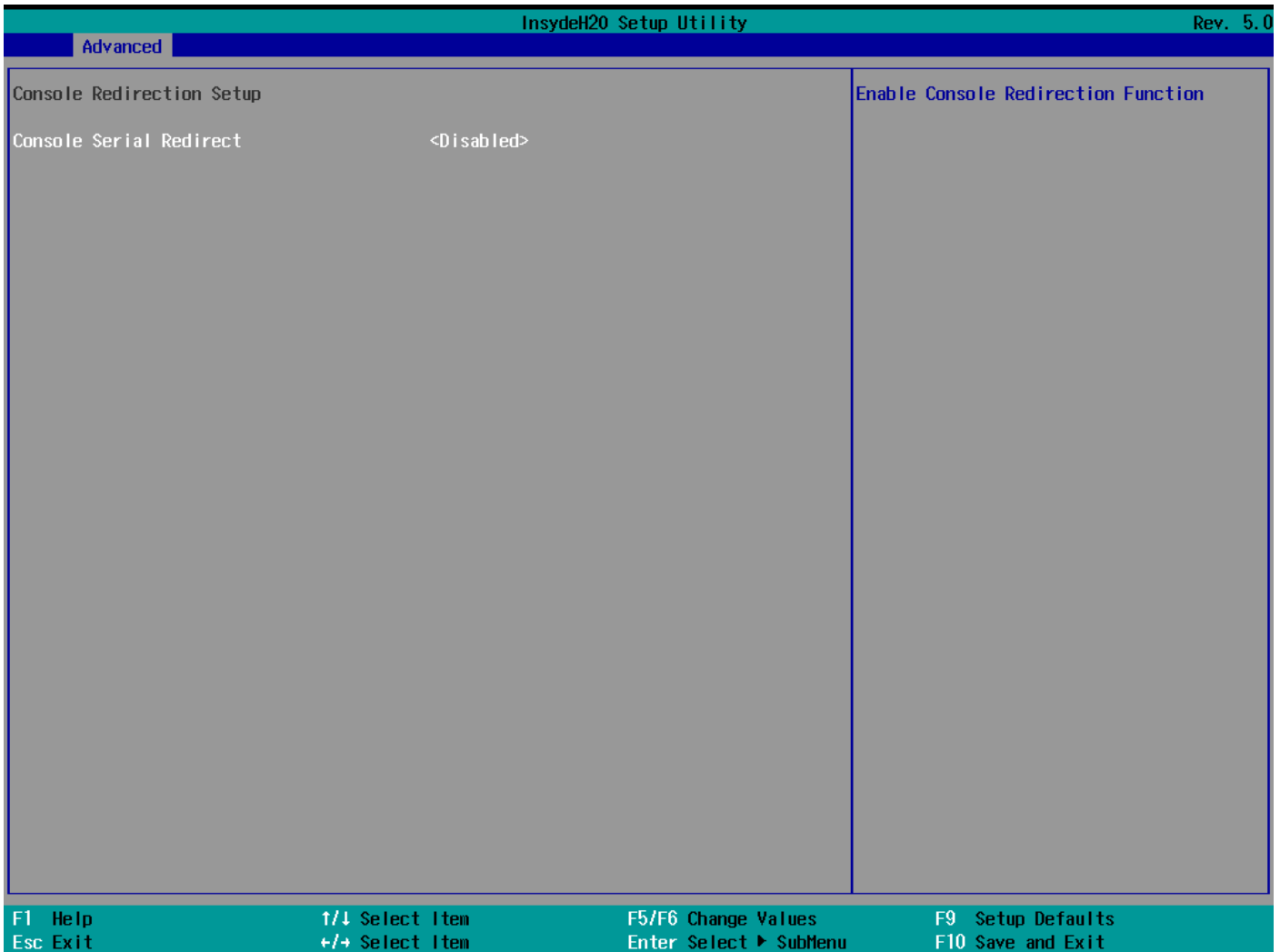

Console Serial Redirect

Enables console redirection function. The display will also output to serial port synchronously.

Smart Recovery Info

This feature allows you to view the smart recovery settings for your computer.



Load Smart Recovery Default

Allows you to load the default values for the Smart Recovery function. For details on the Smart Recovery feature, refer to the *Smart Recover Software User's Manual*.

Options: Yes (default), No

Security Settings

This feature allows you to configure security settings with a supervisor password and user password.

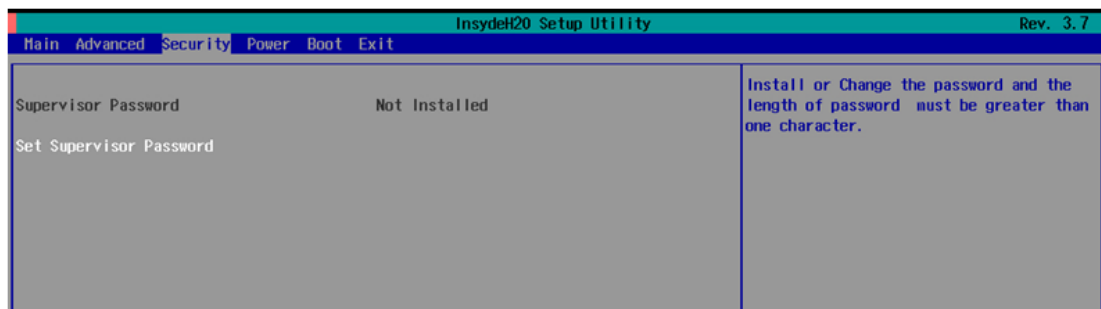

Set Supervisor Password

Allows you set the supervisor password.

To set the password, enter the password, and then confirm the password again.

To delete the password, enter **Set Supervisor Password** and enter the old password. Leave the new password fields blank, and press Enter.

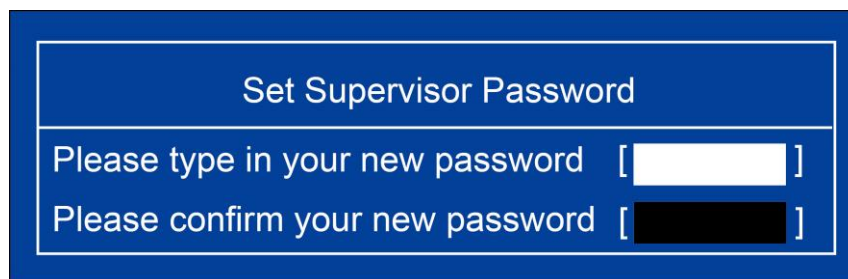

Power Settings

The **Power** menu allows you to configure the power settings for your computer.

The **Advanced CPU Control** option is only available on i7 platform. The **C-States** option is disabled by default.

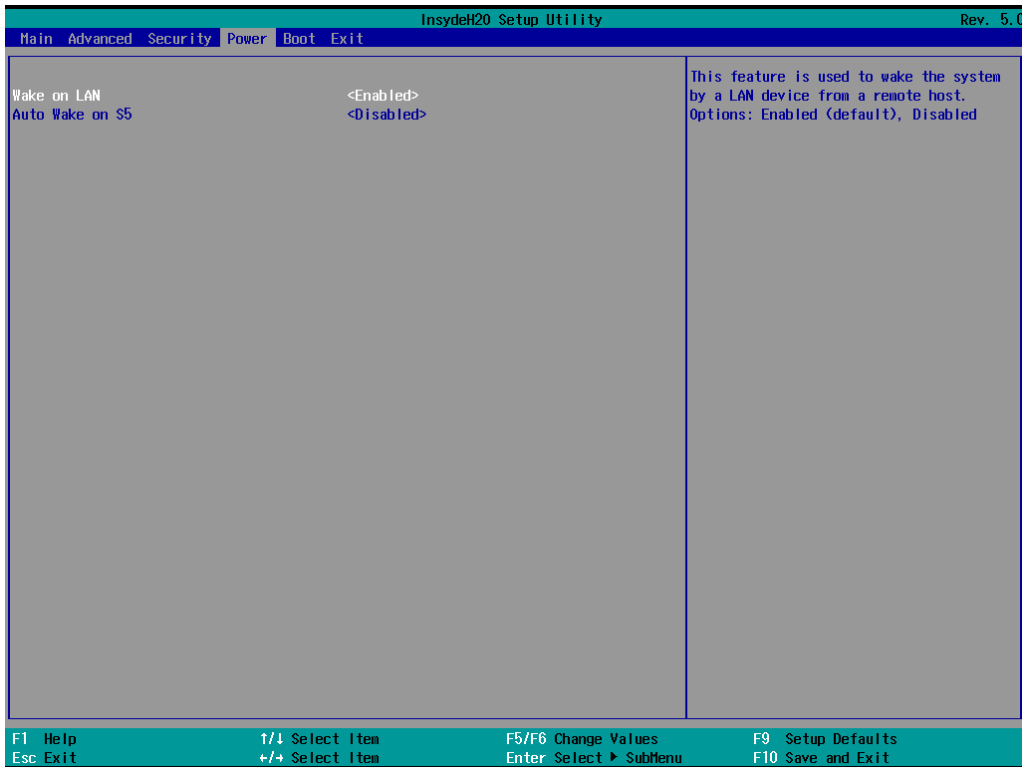

Auto Wake on S5

This feature allows you to configure auto wake up from S5 status. S5 stands for Soft Off, where the PSU remains engaged but power to all other parts of the system is cut off. Auto-wake on S5 schedules a soft-reboot at certain periodic times that can be specified in the BIOS.

Options: Disabled (default); By Every Day (user specifies a regular daily time when the computer will power up); By Day of Month (user specifies a regular day each month when the computer will power up)

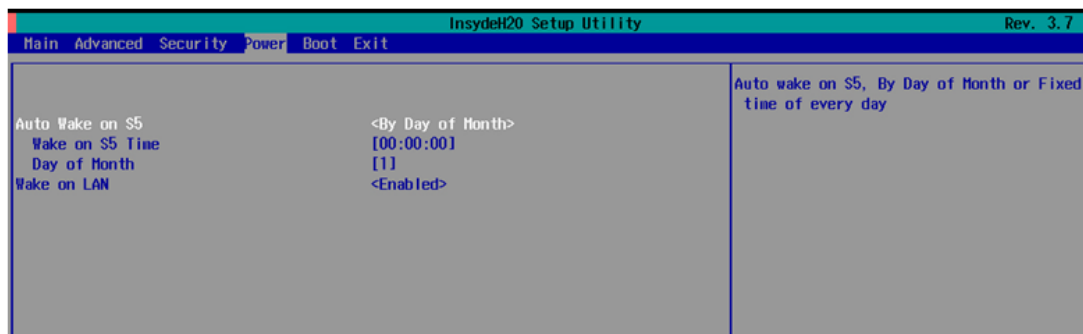

Wake on LAN

This feature is used to configure a wake on the system by a LAN device from a remote host.

Options: Enabled (default), Disable.

Boot Settings

The feature allows you to configure boot settings.

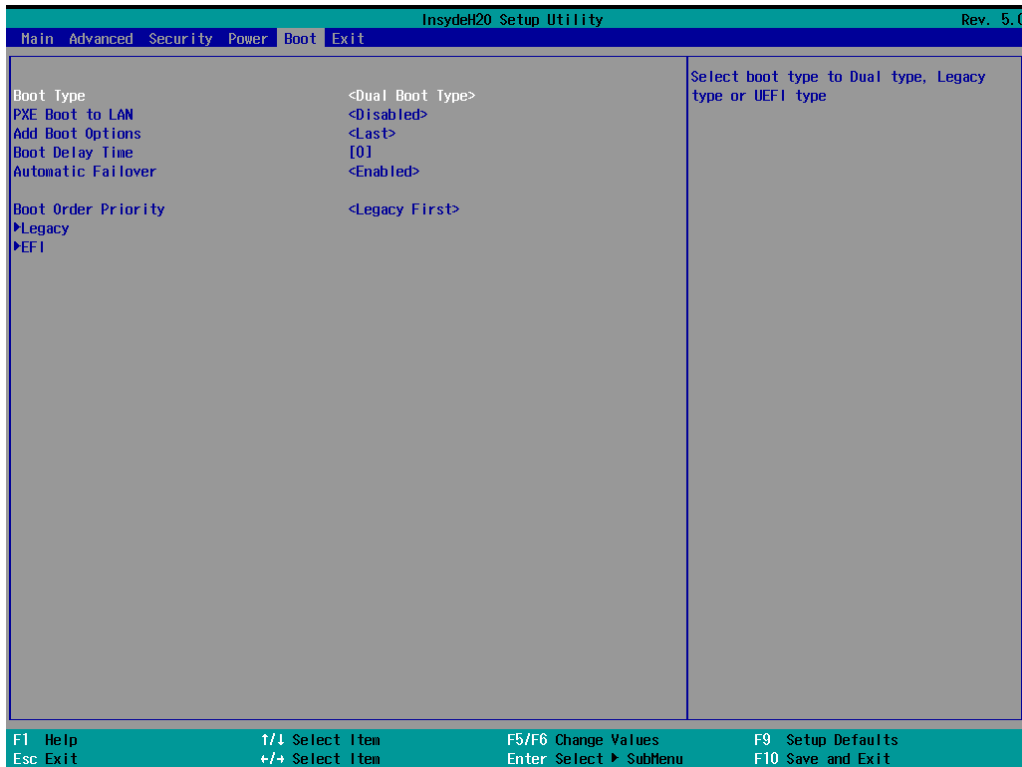

Boot Type

Allows you to enable/disable quick boot function.

Options: Dual Boot Type (default), Legacy Boot Type, UEFI Boot Type.

PXE Boot to LAN

Allows you to enable/disable PXE boot to LAN function.

Options: Disabled (default), Enabled

Add Boot Options

Allows you to add the boot order options for shell, network, and removable media.

Options: Last (default), First

Boot Delay Time

Allows you to configure the delay time value for users to input hot key during POST time.

Options: 0 Second (default), 3 Seconds, 5 Seconds, and 10 Seconds

Automatic Failover

This setting allows you to enable automatic failover to the next boot device if the default device fails to boot.

Enable: If the default device fails to boot, the system will automatically try to boot up the next device.

Disable: If the default device fails to boot, the system will display a warning message and the go into firmware.

Boot Order Priority

This setting allows you to determine the booting priority of the EFI device. If this setting is set to **EFI First**, the EFI device will boot first; if the setting is **Legacy First**, the legacy device will boot first.

Options: Legacy First (default), EFI first

Legacy Normal Boot Menu

This setting allows you to configure the boot menu.

Options: Normal, Advance (default)

Boot Type Order

This setting allows you to configure the boot order of the devices. To change the boot order, use the "-" or "F5" key to move down the list, or the "+" or "F6" key to move up the list, and then press **Enter**.

Options: Hard Disk Drive (default), CD/DVD-ROM Drive, USB, Others

EFI

Adjust boot order settings for EFI device

Exit Settings

The feature allows users to save configuration changes and exit the BIOS environment.

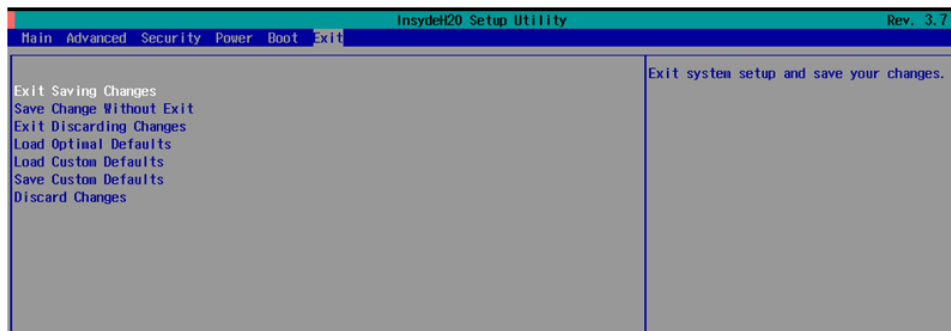

Exit Saving Changes

Allows you to exit the BIOS environment and save the values you have just configured.

Options: Yes (default), No

Save Change Without Exit

Allows you to save changes without exiting the BIOS environment.

Options: Yes (default), No

Exit Discarding Changes

Allows you to exit without saving any changes that might have been made to the BIOS.

Options: Yes (default), No

Load Optimal Defaults

Allows you to revert to the factory default BIOS values.

Options: Yes (default), No

Load Custom Defaults

Allows you to load custom default values for the BIOS settings.

Options: Yes (default), No

Save Custom Defaults

Allows you to save the current BIOS values as a custom default image. You can restore the system to this custom default image anytime using the **Load Custom Defaults** option.

Options: Yes (default), No

Discard Changes

Allows you to discard all settings you have just configured. Options: Yes (default), No

Upgrading the BIOS

This section describes how to upgrade the BIOS.

IMPORTANT BIOS upgrades, if not done correctly, can permanently damage the computer. We strongly recommend that you contact Moxa's technical support staff for assistance in order to obtain all necessary tools and the most current advice before attempting to upgrade the BIOS on any Moxa device.

Step 1: Create a Bootable USB Disk

Before upgrading the BIOS, you must create a bootable USB RAM drive, which you can use as a system rescue device. A useful software suite, Rufus for creating a bootable USB RAM drives can be downloaded at:

<https://rufus.akeo.ie/>

To create a bootable USB disk using Rufus software, do the following:

1. Start Rufus and select the USB device that you want to use as a bootable disk from the **Device** drop-down list.
2. Select **MBR partition scheme for BIOS or UEFI computers** to boot from a legacy BIOS or UEFI.
3. Select **FAT (Default)** from **File system** drop-down list.
4. Select **16 kilobytes (Default)** for **Cluster size**.
5. Enter a drive name under **New volume label**.
6. Select the **Quick format, Create a bootable disk using FreeDOS**, and **Create extended label and icon files** format options.
7. Click **Start** to format and create the bootable USB drive.

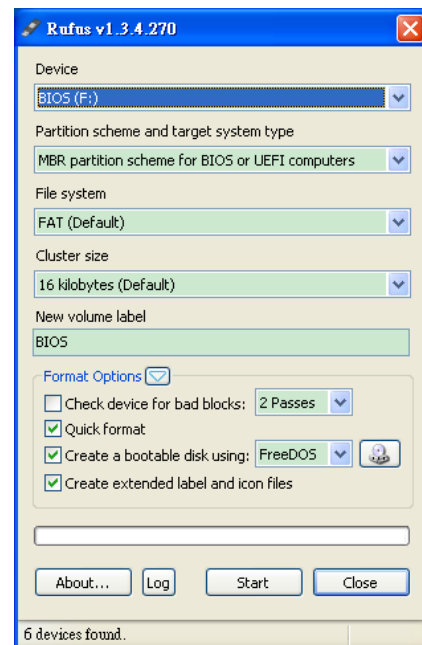

ATTENTION

We suggest you use a USB drive with under 2 GB disk space, as larger USB drives may not support FAT file format and consequently fail to boot.

Step 2: Prepare the Upgrade File

You must use the BIOS upgrade installation file to upgrade the BIOS. Contact Moxa's technical department for assistance.

1. Get the BIOS upgrade installation file. The file name should have following format: **682AxxSx.exe** (xx refers to version numbers).
2. Copy the file to the Bootable USB Disk.

Step 3: Run the upgrade program on the DA-720-DPP Computer

1. Reboot the computer, press F12 while booting up to enter the Boot Manager
2. Select USB Disk as the first boot source. Press Enter to continue.



3. When the boot up process is complete, the DOS screen is displayed. Go to the directory where the upgrade file is located. For example, if the upgrade file is stored in the DA-720 folder, type `cd DA-720`.

```
C:\cd DA-720
```

4. Run the upgrade program by typing `DA-72010017.exe`. Please note that the upgrade filename will vary depending on the computer versions.

```
C:\ DA-720>DA-72010017.exe
```

5. Wait until the upgrade process is complete.

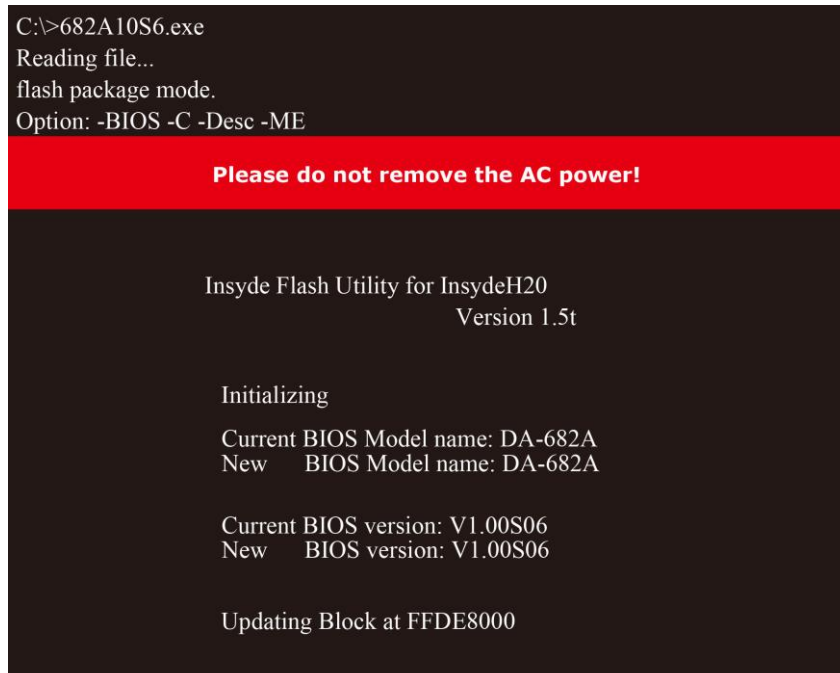

- When the upgrade is finished, the computer will automatically reboot. You can check the BIOS version on Main page of the BIOS Setup to confirm the upgrade.

**ATTENTION**

DO NOT switch off the power supply during the BIOS upgrade, since doing so may cause the system to crash.

A

Safety Installation Instructions

A. RTC Battery Warning

CAUTION: There is a risk of explosion if battery is replaced by an incorrect type. Dispose of used batteries according to the instructions.

B. Fuse Warning

CAUTION: For continued protection against fire, replace only with same type and rating of fuse.

C. Rackmount Warning

The following or similar rackmount instructions are included with the installation instructions:

(1) Elevated Operating Ambient: If installed in a closed or multi-unit rack assembly, the operating ambient temperature of the rack environment may be greater than the room ambient temperature. Therefore, consideration should be given to installing the equipment in an environment compatible with the maximum ambient temperature (T_{ma}) specified by the manufacturer.

(2) Reduced Air Flow: Installation of the equipment in a rack should be such that the amount of air flow required for safe operation of the equipment is not compromised.

(3) Mechanical Loading: Mounting of the equipment in the rack should be such that a hazardous condition is not achieved due to uneven mechanical loading.

(4) Circuit Overloading: Consideration should be given to the connection of the equipment to the supply circuit and the effect that overloading of the circuits might have on overcurrent protection and supply wiring. Appropriate consideration of equipment nameplate ratings should be used when addressing this concern.

(5) Reliable Grounding: Reliable grounding of rack-mounted equipment should be maintained. Particular attention should be given to supply connections other than direct connections to the branch circuit (e.g., by using power strips).