



# Edgeport<sup>®</sup>

USB Expansion Modules

---

## Installation Guide

## Revision history—90000403

Revision	Date	Description
K	July 2013	Removed the DoC section.
L	November 2013	Updated driver support information for newer Windows OS.
M	December 2017	Updated branding and made editorial enhancements.
N	March 2020	Added information about <a href="#">Edgeport/216</a> .
P	October 2020	Add <a href="#">RS232 DB9 Connector</a> information. Removed information about obsolete models: Edgeport 4r, 8r, and 22c.

## Trademarks and copyright

Digi, Digi International, and the Digi logo are trademarks or registered trademarks in the United States and other countries worldwide. All other trademarks mentioned in this document are the property of their respective owners.

© 2018 Digi International Inc. All rights reserved.

## Disclaimers

Information in this document is subject to change without notice and does not represent a commitment on the part of Digi International. Digi provides this document “as is,” without warranty of any kind, expressed or implied, including, but not limited to, the implied warranties of fitness or merchantability for a particular purpose. Digi may make improvements and/or changes in this manual or in the product(s) and/or the program(s) described in this manual at any time.

## Warranty

To view product warranty information, go to the following website:

[www.digi.com/howtobuy/terms](http://www.digi.com/howtobuy/terms)

## Send comments

**Documentation feedback:** To provide feedback on this document, send your comments to [techcomm@digi.com](mailto:techcomm@digi.com).

## Customer support

**Digi Technical Support:** Digi offers multiple technical support plans and service packages to help our customers get the most out of their Digi product. For information on Technical Support plans and pricing, contact us at +1 952.912.3444 or visit us at [www.digi.com/support](http://www.digi.com/support).

# Contents

---

## Edgeport products

### Edgeport/1, Edgeport/2, Edgeport/4, Edgeport/8

Cabling Edgeport .....	5
------------------------	---

### Edgeport/216, Edgeport/416

Cabling Edgeport .....	6
------------------------	---

## Edgeport mounting diagrams

## Edgeport driver installation

## RS232 DB9 connector pin assignments

RS232 DB9 Connector .....	11
RS232 DB9 Diagnostics loop-back plug for Edgeport/1, 2, 4, 8, 16 .....	11

## Edgeport configuration utility

General tab .....	13
Information tab .....	14
Configuration tab .....	15
Port Flag Configuration tab .....	16
Confidence Test tab .....	18
Power Management tab .....	19
Port Status tab .....	20
Version tab .....	21
Advanced tab .....	22

## Edgeport system status light

## Understanding hubs

## Regulatory information

## Edgeport products

---

This installation guide covers the following models:

- Edgeport/1
- Edgeport/2
- Edgeport/4
- Edgeport/8
- Edgeport/216
- Edgeport/416
- Edgeport/2c

Edgeport USB-to-Serial Converters offer an out-of-the-box alternative to serial cards for easy plug-and-play COM port expansion. Multiple serial and USB ports can be added to a PC, thin client or server in minutes — without opening the chassis or reconfiguring and rebooting the system. Its feature-rich design, reliable performance and operating system support make the Edgeport an excellent choice for mission-critical enterprise applications.

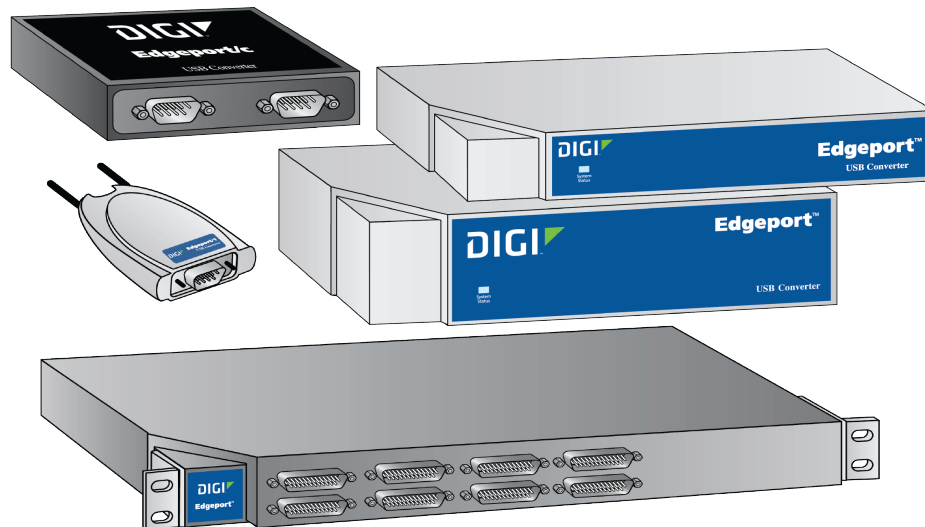

## **Edgeport/1, Edgeport/2, Edgeport/4, Edgeport/8**

The Edgeport/2, Edgeport/4, and Edgeport/8 from Digi International are intelligent, stackable expansion modules that connect to a PC or server running Windows XP, Server 2003 (R2), Server 2008 (R2), Windows 7, Windows 8, Windows Server 2012 (R2), Windows 10 and Windows Server 2016, via the Universal Serial Bus (USB), providing high-speed serial connectivity. For more detailed information as well as the latest manual and technical updates, visit [www.digi.com/support](http://www.digi.com/support).

### **Cabling Edgeport**

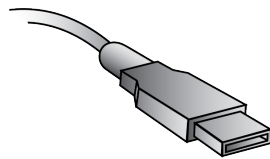

Type A

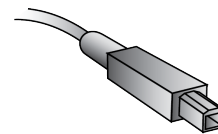

Type B

Plug the Type A end of the USB cable into the USB port located in the back of your PC or into an available USB port on a standard hub or into a Digi Hubport. Plug the Type B end of the USB cable into the back of the Edgeport.

If the drivers are not already installed, go to [Edgeport driver installation](#).

## Edgeport/216, Edgeport/416

---

The Edgeport/216 and the Edgeport/416 both use a standards-based USB bus for connectivity, unlike many serial card products that require additional external proprietary hardware to support the same number of devices.

### Edgeport/216

The Edgeport/216 also supplies two USB ports, providing users with a built-in migration path as peripherals become USB-ready. The converters can be rack mounted and easily daisy-chained together. This Edgeport converter is available with DB9 connectors.

### Edgeport/416

The Edgeport/416 also supplies four USB ports, providing users with a built-in migration path as peripherals become USB-ready. The converters can be rack mounted and easily daisy-chained together. This Edgeport converter is available in two models: one with DB25 connectors and one with DB9 connectors. The two models are functionally equal, but differ in the type and placement of the connectors.

## Cabling Edgeport

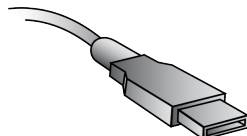

Type A

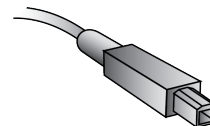

Type B

Connect one end of the power supply into the back of your Edgeport and the other end into an AC outlet.<sup>1</sup>

To connect your Edgeport to a PC or Hub, plug the Type A end of the USB cable into the USB port located in the back of your PC or into an available USB port on a standard hub or into a Digi Hubport. Plug the Type B end of the USB cable into the back of the Edgeport/416.

---

<sup>1</sup>Power to the Edgeport-DB25 and Edgeport-DB9 may be supplied by a UL Listed Direct Plug-In Power Unit or Information Technology Equipment Rated Power Unit rated 5 VDC, at least 2.9 A if used in the U.S. and Canada or a power supply with + - similar rating and approved by your local safety code if it is used elsewhere.

For polarity, see diagram to the right.



To connect a USB device to your Edgeport, plug the Type A end of the USB cable into one of the Edgeport's USB Type A slots and the Type B end of the USB cable into the device (such as a Rapidport or Hubport ).

If the drivers are not already installed, go to [Edgeport driver installation](#).

## Edgeport mounting diagrams

---

The following mounting diagram applies to the Edgeport/2, Edgeport/4 and /4R, and Edgeport 8 and /8R. Edgeport/416 is shown on a subsequent page.

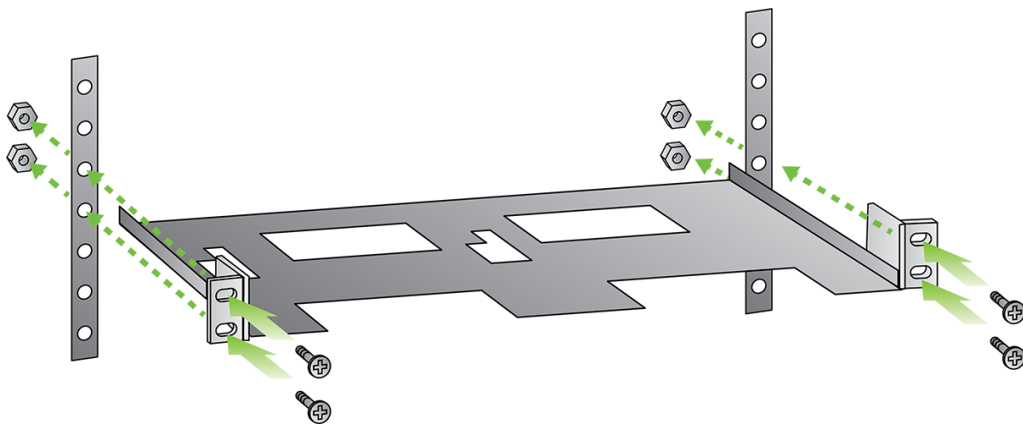

Rack Mount Kit<sup>1</sup>

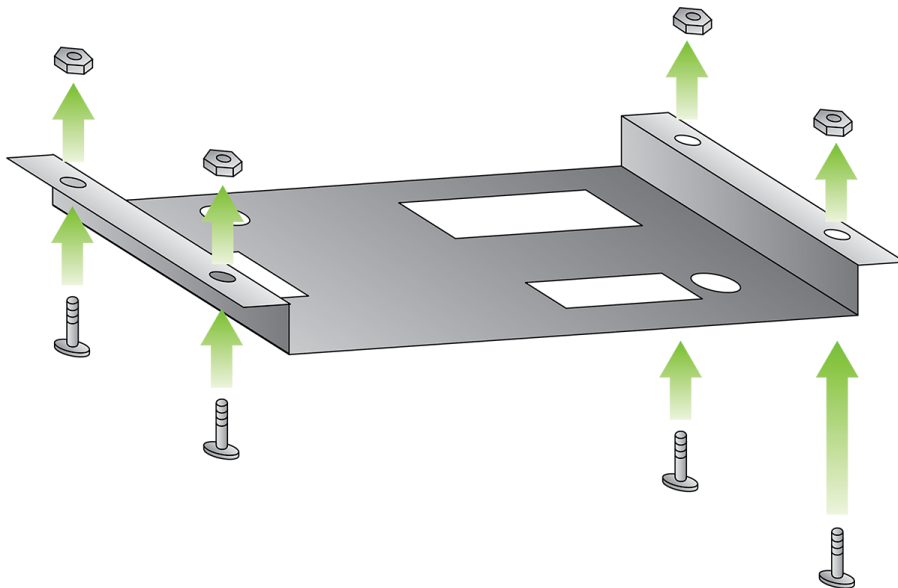

Under-Shelf Mounting Bracket<sup>1</sup>

<sup>1</sup>Nuts, bolts, and screws are not included.



## Edgeport/416

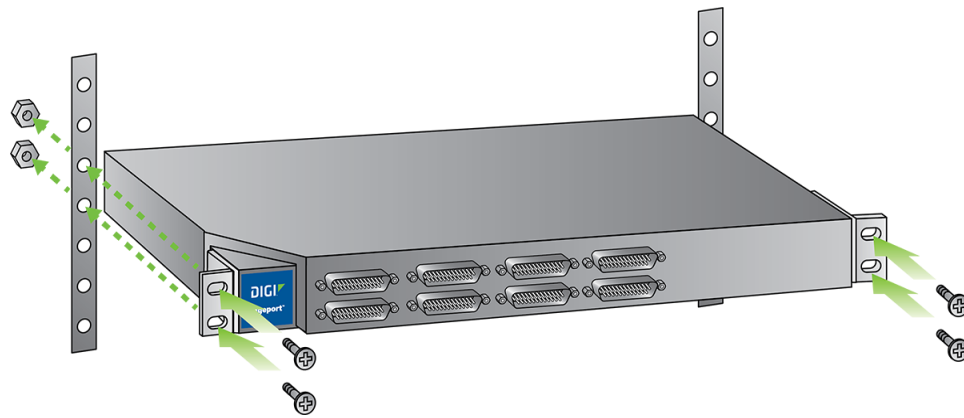

For Edgeport/416<sup>1</sup>

<sup>1</sup>Nuts, bolts, and screws are not included.

## Edgeport driver installation

---

The following instructions apply to Windows 7, Windows 8.1, Windows Server 2012 (R2), Windows 10, Windows Server 2016, and Windows Server 2019.

---

**Note** Please go to [www.digi.com](http://www.digi.com) to download software for older operating systems.

---

You must be logged into an account with administrator privileges before proceeding.

1. Make sure the Edgeport device is not connected to the computer.
2. If you have installed a previous Edgeport driver, use the Edgeport configuration utility that came with your driver package to uninstall the driver:
  - a. Click the **Uninstall** button from the **Advanced** tab.
  - b. Reboot the computer when prompted.
3. Download the most current Edgeport drivers from the Digi website:
  - a. Navigate to [www.digi.com](http://www.digi.com) using a web browser.
  - b. Select **Support Tools** from the **Support** menu.
  - c. Under the **Support Downloads** menu, select **Drivers**.
  - d. Select **Edgeport USB** from the list.
  - e. Select the appropriate Windows Operating System from the dropbox.
  - f. The driver download link will appear underneath the OS dropbox. Save this .exe file somewhere convenient such as your desktop.
4. Install the Edgeport driver:
  - a. Log into Windows with the administrator user account, or another account with administrative privileges.
  - b. Run the downloaded **.exe** file and wait until the installation is complete.
  - c. Connect the Edgeport to the computer with a USB cable. Or, if the Edgeport is already connected to the computer via USB, unplug and plug it in again.
  - d. The Edgeport drivers will automatically install.

Your new COM port(s) are ready and are numbered sequentially following the existing ports in your system. You can now run the Edgeport configuration utility, described in the next section.

## RS232 DB9 connector pin assignments

---

Use the table to find the RS232 DB9 connector pin assignments.

### RS232 DB9 Connector

DB-9M	Function	Abbreviation
Pin 1	Data Carrier Detect	CD
Pin 2	Receive Data	RD or RX or RXD
Pin 3	Transmitted Data	TD pr TX or TXD
Pin 4	Data Terminal Ready	DTR
Pin 5	Signal Ground	GND
Pin 6	Data Set Ready	DSR
Pin 7	Request To Send	RTS
Pin 8	Clear To Send	CTS
Pin 9	Ring Indicator	RI

### RS232 DB9 Diagnostics loop-back plug for Edgeport/1, 2, 4, 8, 16

Function	Pin
RTS to CTS, RI	Pins 7, 8, 9
DTR to DSR, CD	Pins 1, 4, 6
TXT to RXD	Pins 2, 3

## Edgeport configuration utility

---

The following instructions apply to all Windows operating systems.

The Edgeport configuration utility program allows you to manage the serial ports of your Edgeport product. The Edgeport configuration utility is available from the computer's **Start** menu after you install the Edgeport drivers.

Follow these steps to access the configuration utility:

1. Download the Edgeport drivers, following the instructions in [Edgeport driver installation](#).
2. Once the drivers are installed, launch the Edgeport configuration utility from the Digi USB program group on the computer's **Start** menu.

## General tab

The **General** tab in this utility allows you to perform tasks such as configuring the device's COM ports, setting port flags and testing the ports. See the subsections that follow for additional details.

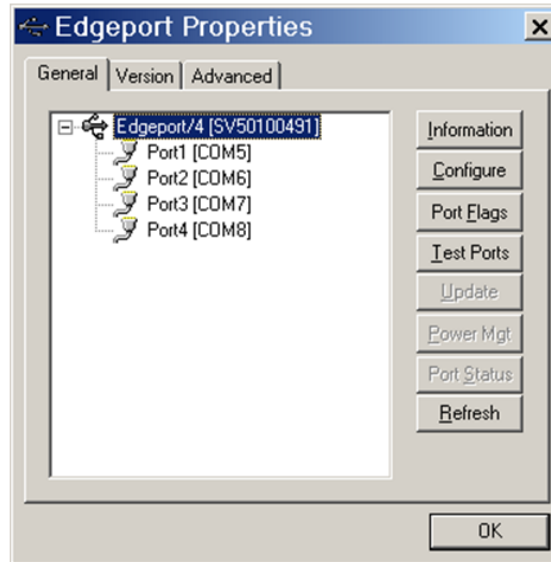

## Information tab

The **Information** tab allows you to review the manufacturing information pertaining to your device.

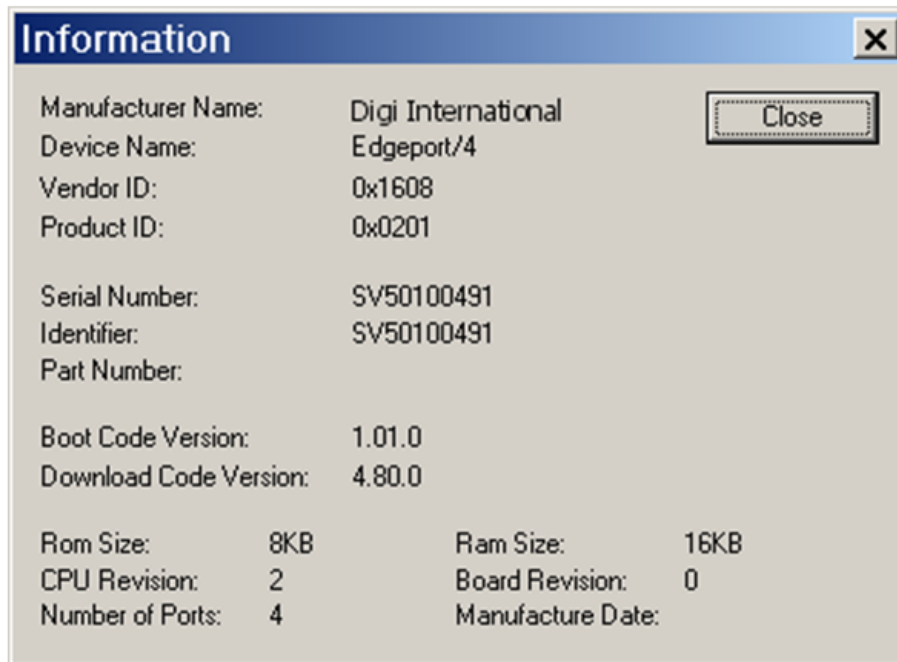

## Configuration tab

The **Configuration** tab allows you to reassign the physical port on your device to any available Windows COM port number from 1 to 255 and give your device a user friendly device name. This capability is particularly helpful if you have more than one device.

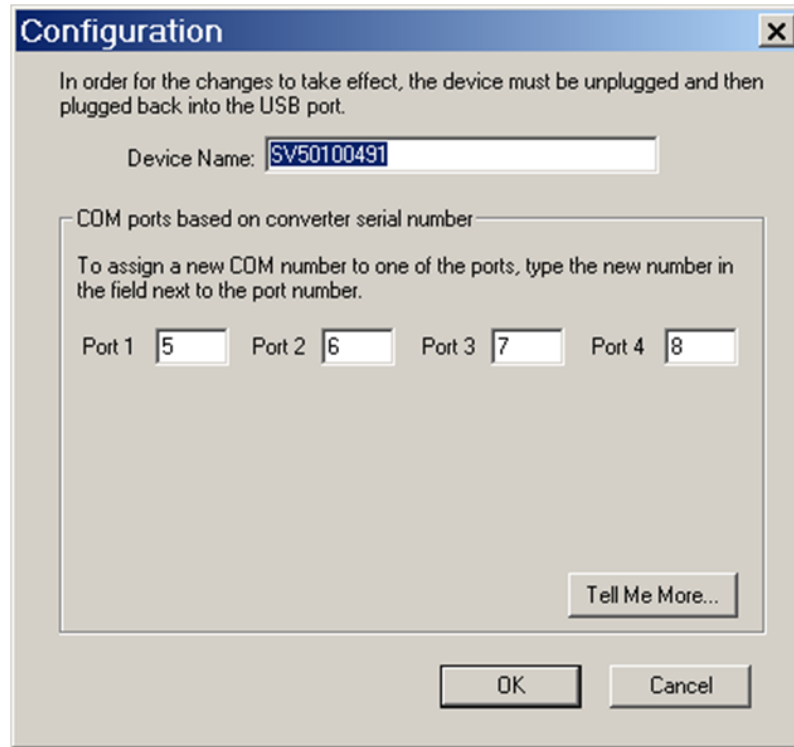

## Port Flag Configuration tab

The **Port Flag Configuration** tab allows you to configure performance options and special functionality on a per-port basis.

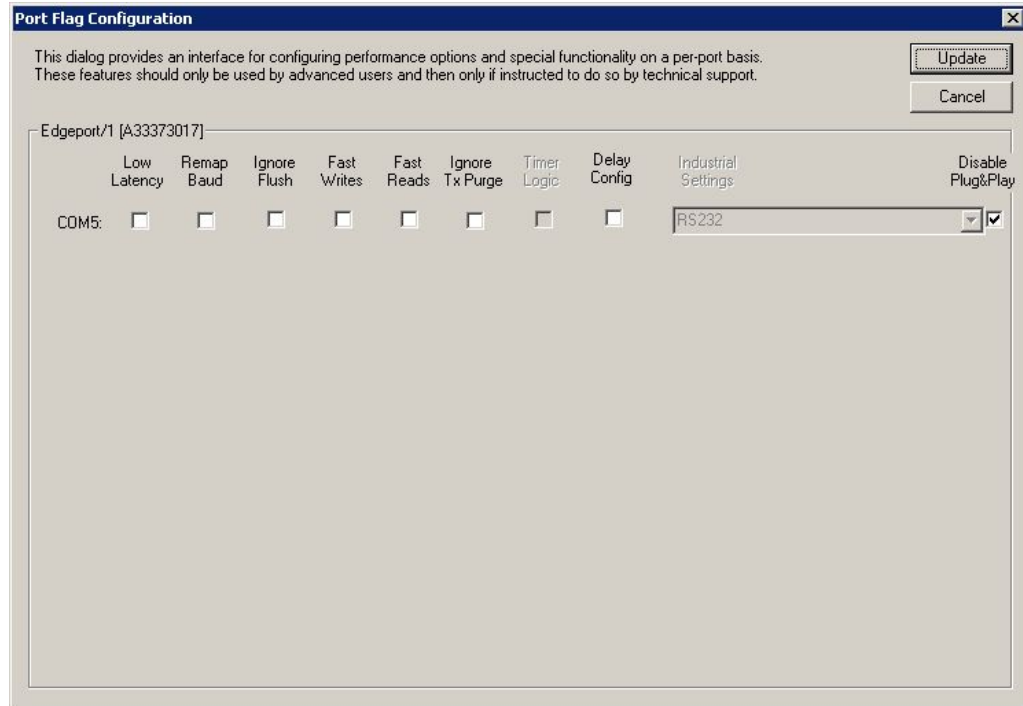

- **Low Latency** (930-based Edgeport only):

Normally the UART will interrupt when the receiver has been idle for 4 character times (for example, 4ms at 9600). As long as data is being received, the UART will continue to buffer them until its internal FIFO is full (~56 bytes). This flag causes the Edgeport to poll the RX FIFO for received bytes. If any bytes are available, they will be sent to the driver without any delay.

- **Remap Baud**: Setting the baud rate to 1200 baud results in 230400 baud.

- **Ignore Flush**:

If an application sends IRP\_MJ\_FLUSH\_BUFFERS, it will be ignored. The following is an excerpt from Microsoft documentation:

*Drivers of devices with internal caches for data and drivers that maintain internal buffers for data must handle this request.*



- **When Sent**

Receipt of a flush request indicates that the driver should flush the device's cache or its internal buffer, or, possibly, should discard the data in its internal buffer.

- **Operation**

The driver transfers any data currently cached in the device or held in the driver's internal buffer(s) before completing the flush request. The driver of an input-only device that buffers data internally might simply discard the currently buffered device data before completing the flush IRP, depending on the nature of its device.

- **Fast Writes:**

When an application sends a write to the driver, by default the Edgeport driver will wait until all data has been transmitted out of the Edgeport device before completing the write. When the Fast Writes flag is set, we complete the write even if data is still buffered in the driver and the Edgeport device.

- **Fast Reads:**

This flag is used when an application requires that a read complete immediately. In the read immediate case, the Edgeport driver will send a request to the Edgeport device asking for any buffered data to be sent up. This buffered data will be included when the read completes. If this flag is set, the driver will not query the Edgeport device for additional data.

- **Disable Plug & Play:**

Uncheck this to allow Windows to detect Plug and Play serial devices, such as most modems.

- **Timer Logic:** (Windows 9x only)

If the application uses `PortSetReadCallBack()`, the notification routine will only be called when the number of bytes in the receive buffer is greater than the RX trigger. The Microsoft serial VxD also implements a timer that will trigger and call the notification routine if some amount of data is available in the RX buffer but no new data has been received for ~200ms (receiver is no longer active).

We do not enable this behavior by default because of the nature of Edgeport buffering. But if you set the flag we will complete the read when we detect ~200 ms no activity.

The code specifies that if the receiver is active, the read will not be completed.

The problem is that the Edgeport buffers the RX bytes and we poll the driver. If we do not receive any bytes in 200ms we may report an erroneous event even if there are available bytes in the Edgeport device or driver.

## Confidence Test tab

The **Confidence Test** tab allows you to perform a confidence test on the internal workings of the serial ports.

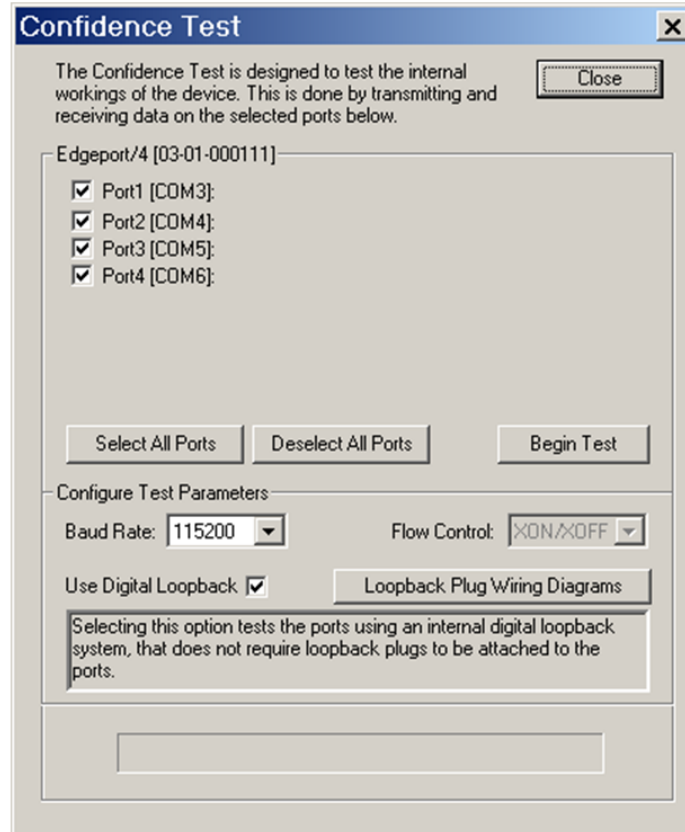

## Power Management tab

The **Power Management** tab allows you to turn the power on and off for select model Hubports with USB PlusPower ports.

**Note** This applies to Compact (/c) or PCI card PlusPower Hubport models. This feature does not toggle the 5 V standard USB port. It only applies to the 12 V and 24 V USB ports.

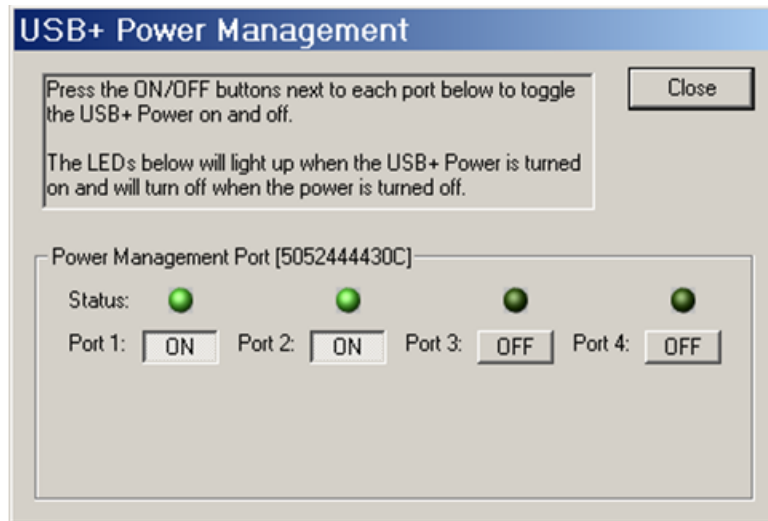

## Port Status tab

The **Port Status** tab provides the status of a selected (highlighted) serial port.

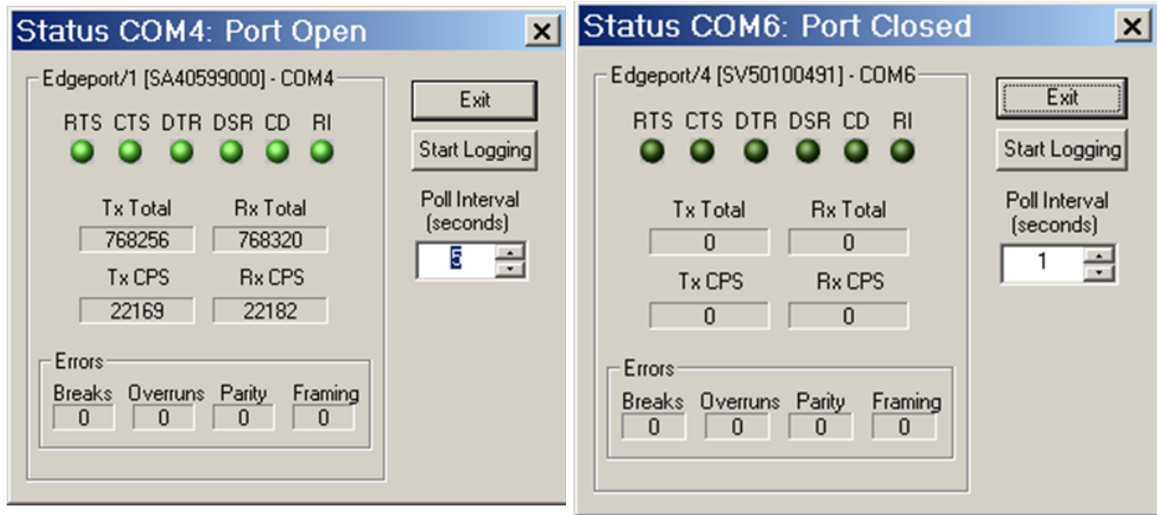

The Poll Interval is the number of seconds between updates of this window. This is also the number of seconds between each entry in the log file.

To create a log file, click the **Start Logging** button and enter a filename for the log file. This file will contain all of the information displayed in the **Port Status** window until you click **Stop Logging** button.

## Version tab

The **Version** tab allows you to review the file information pertaining to the software.

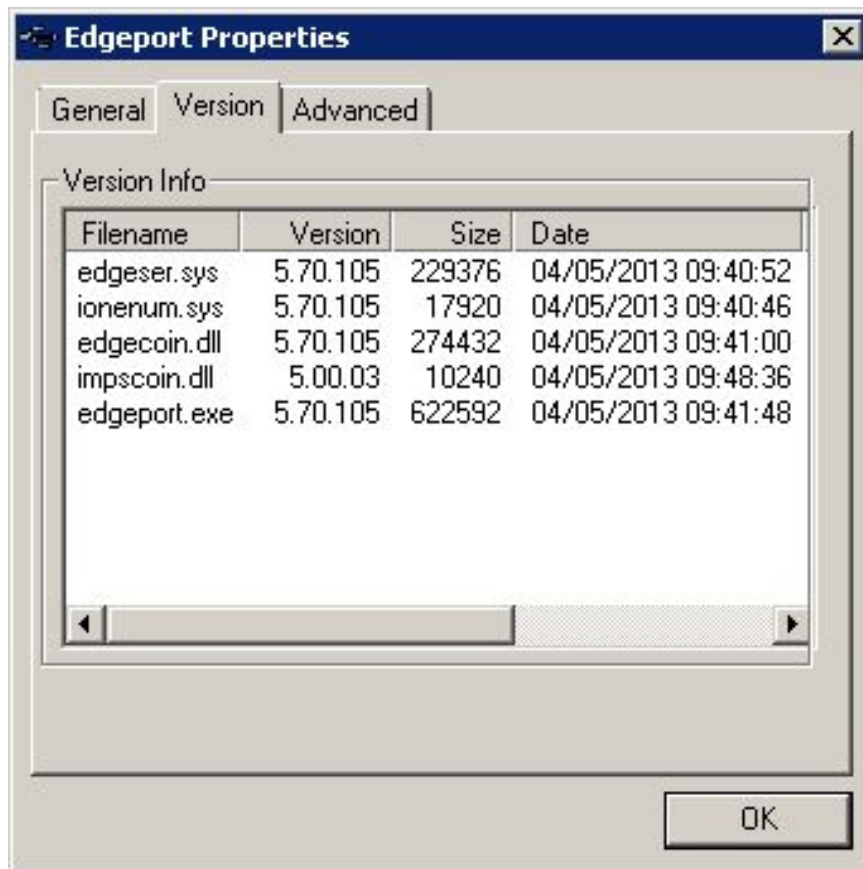

## Advanced tab

The **Advanced** tab allows you to do several advanced tasks. See the subsections that follow for more detailed information.



- **Uninstall** - Uninstall the Edgeport drivers.

---

**Note** You must reboot the computer after uninstalling the drivers.

---

- **Enable Event Logging** – Place event messages in the system event log.

- **COM Port Assignment** - Configure how COM ports will be assigned.
  - Assign COM ports based on converter serial number.

This is the default setting. In this mode, the driver uses the serial number of each converter to uniquely identify it, and the COM port assignments for a given converter are based on its serial number. No matter which physical USB port a converter is plugged into, it will maintain its assigned COM port numbers.
  - Assign COM ports based on physical USB port.

In this mode, the driver identifies a converter based on the physical USB port it is plugged into. This effectively assigns COM port numbers to physical USB ports. No matter which converter is plugged into a given USB port, it will use the COM port numbers assigned to that USB port. This permits a converter to be replaced with a new unit, and, although the new unit has a different serial number, it will receive the same COM port assignments as the old unit because they were both plugged into the same USB port.

When using this mode, converters are identified not by their serial number, but by a 2-7 digit number that identifies which USB port it is plugged into.

When the COM ports are assigned, click **OK**. You must reboot the computer before the change takes effect.

## Edgeport system status light

---

### For all Edgeport devices except the Edgeport/1

The functionality of the system status light is as follows for multi-port Edgeport products, with the exception of the Edgeport/1, which does not have LED indicators.

**Off** - No light indicates that the Edgeport driver is not properly installed.

**Red** - This light may flash briefly during installation.

**Orange** - Blinking orange indicates Edgeport serial port activity. This light may also flash briefly during installation.

**Green** - Blinking green indicates that the Edgeport driver is properly installed and operating normally, and the unit is idle, ready for use.



## Understanding hubs

---

Hubs, which are critical components in the USB architecture, are wiring concentrators that enable the attachment of multiple devices, thus converting a single attachment point into multiple attachment points. USB architecture allows a cascaded multiple hub configuration with certain power limitations (explained later in this section).

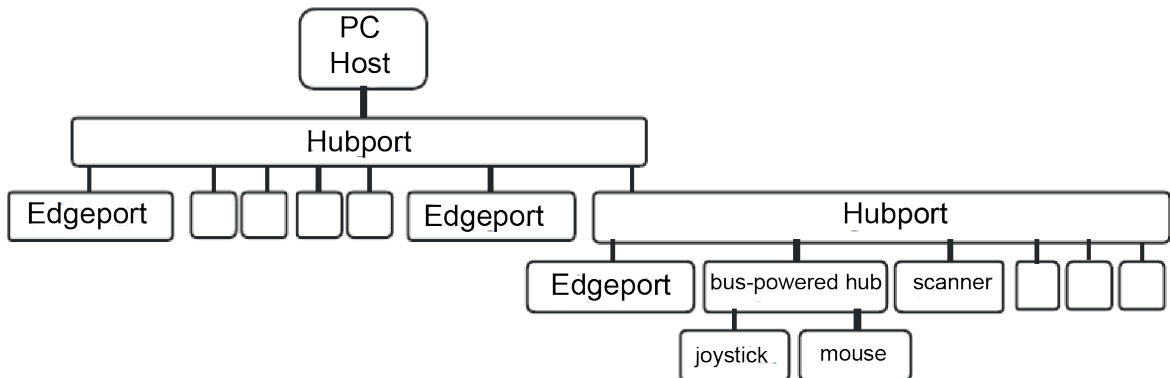

Each hub has an upstream port, connecting to the host, and multiple downstream ports, connecting to downstream devices, possibly including other hubs. A hub can detect attachment and detachment of downstream devices and enable and monitor the distribution of the power to downstream devices via their integral hardware and the operating system.

Each USB device reports its power requirements to the operating system, which then enables and disables the device as a function of its power requirements and the amount of available power. High powered devices typically need to be connected to a self-powered hub, such as the Hubport, which obtains power from its external power supply and provides up to 500 mA for each downstream port. A low-powered device, such as a mouse, can be connected to a bus-powered hub, which obtains power from its upstream host and provides up to 100 mA for each downstream port.

Due to the limited available power for bus-powered hubs, cascading two bus-powered hubs is an illegal topology, and devices connected to the second hub will not function. *USB specifications limit the connection of a bus-powered hub to a self-powered hub or host only.* Since Edgeport/421, Edgeport/42, Edgeport/42+, and Edgeport/416 operate as self-powered hubs, they are not affected by this limitation.

According to the USB Specification, the maximum limit of hubs cascaded in a series cannot exceed five. In other words, you may have a maximum of five hubs between any device and the host. This does NOT mean that the maximum number of hubs in a system is five. You can parallel-connect up to seven hubs can be connected parallel *at any given level*. You must tally both external and embedded hubs when counting downstream hubs.

## Regulatory information

---

Digi complies with all U.S. federal regulations for digital devices as well as the international regulations described below.

### Regulatory statements

#### **For U.S. Government use:**

Computer software is furnished with Restricted Rights in accordance with FAR 52.227-14. Technical Data is furnished with Limited Rights in accordance with DFAR 252.227-7013 (b) (3) of the clause entitled RIGHTS IN TECHNICAL DATA – NONCOMMERCIAL ITEMS.”

#### **For non-U.S. Government use:**

These programs are supplied under a license. They may be used, disclosed, and/or copied only as supplied under such license agreement. Any copy must contain the above copyright notice and restricted rights notice. Use, copying, and/or disclosure of the programs is strictly prohibited unless otherwise provided for in the license agreement.

#### **Radio Frequency Interface (RFI) (FCC 15.105)**

This device has been tested and found to comply with the limits for Class B digital devices pursuant to Part 15 Subpart B, of the FCC rules. These limits are designed to provide reasonable protection against harmful interference in a residential environment. This equipment generates, uses, and can radiate radio frequency energy, and if not installed and used in accordance with the instruction manual, may cause harmful interference to radio communications. However, there is no guarantee that interference will not occur in a particular installation. If this equipment does cause harmful interference to radio or television reception, which can be determined by turning the equipment off and on, the user is encouraged to try and correct the interference by one or more of the following measures:

- Reorient or relocate the receiving antenna.
- Increase the separation between the equipment and receiver.
- Connect the equipment into an outlet on a circuit different from that to which the receiver is connected.
- Consult the dealer or an experienced radio/TV technician for help.

#### **Labeling Requirements (FCC 15.19)**

This device complies with Part 15 of FCC rules. Operation is subject to the following two conditions: (1) this device may not cause harmful interference, and (2) this device must accept any interference received, including interference that may cause undesired operation.

If the FCC ID is not visible when installed inside another device, then the outside of the device into which the module is installed must also display a label referring to the enclosed module FCC ID.

#### **Modifications (FCC 15.21)**

Changes or modifications to this equipment not expressly approved by Digi may void the user's authority to operate this equipment.

#### **Industry Canada**

This digital apparatus does not exceed the Class B limits for radio noise emissions from digital apparatus set out in the Radio Interference Regulations of the Canadian Department of Communications.

Le present appareil numerique n'emet pas de bruits radioelectriques depassant les limites applicables aux appareils numeriques de la class B prescrites dans le Reglement sur le brouillage radioelectrique edicte par le ministere des Communications du Canada.

#### **Europe**

For OEM labeling, the "CE" mark must be affixed to a visible location on the OEM product. The following figure shows CE labeling requirements.

The CE mark shall consist of the initials "CE" taking the following form:

- If the CE marking is reduced or enlarged, the proportions given in the above graduated drawing must be respected.
- The CE marking must have a height of at least 5 mm except where this is not possible on account of the nature of the apparatus.
- The CE marking must be affixed visibly, legibly, and indelibly.

Conforms to the relevant EU Directives listed here:

If the Edgeport® USB is incorporated into a product, the manufacturer must ensure compliance of the final product with articles 3.1a and 3.1b of the RE Directive (Radio Equipment Directive).

#### **Declaration of Conformity (DoC)**

Digi has issued Declarations of Conformity for the Digi Edgeport products concerning emissions, EMC, and safety.

## **China RoHS statement**

The Table of Toxic and Hazardous Substances/Elements and their Content shall apply to any product covered by this manual and labeled with the following symbol: