

Vlinx™ Modbus Gateways

MESR9xx series

USER MANUAL



ADVANTECH

Advantech - Americas

707 Dayton Road
Ottawa, IL 61350 USA
Phone (815) 433-5100
Fax (815) 433-5105

Advantech - European Headquarters

Westlink Commercial Park
Oranmore, Co. Galway, Ireland
Phone +353 91-792444
Fax +353 91-792445

www.advantech.com
support@advantech-bb.com

CONTENTS

ABOUT THIS DOCUMENT	6
1. INTRODUCTION	7
About MESR9xx Modbus Gateways	7
MESR9xx Modbus Gateways – Numbering Matrix.....	8
List of MESR9xx Modbus Gateway Models	9
MESR9xx Modbus Gateway Features	10
Vlinux™ Manager Configuration Software	10
2. MESR9xx MODBUS GATEWAY HARDWARE	11
Package Checklist	11
MESR9xx Modbus Gateway Enclosures & Mounting.....	11
LED Indicators	12
E1/E2 Ethernet Link LED.....	12
Ready LED.....	12
Serial Port LEDs.....	12
Mode Switch	13
Ethernet Connector.....	13
Fiber Optic Connectors	14
Serial Port Connectors.....	14
Power Connector	15
Mounting Hardware	15
3. MODBUS GATEWAY SETUP & CONNECTIONS	16
Connecting the Power Supply.....	16
Connecting MESR9xx Modbus Gateways to Modbus Networks	16
Connecting the MESR9x2T-x	18

Connecting MESR9xx Modbus Gateways to a Network.....	18
Network Connection (10BaseT/100BaseTX)	18
Fiber Optic Connection	18
MESR9xx Modbus Gateway Configuration Connections.....	18
Installing Modbus Configuration Manager Software	19
Configuring the Gateway via the Network Connection	23
Configuring with Modbus Configuration Manager	23
Configuring the MESR9xx Modbus Gateway on Networks without a DHCP Server	38
Configuring the MESR9xx Modbus Gateway via the Serial Port (Console Mode)	41
MESR9xx Modbus Gateway Operational Connections	43
Using MESR9xx Modbus Gateways in Direct IP Mode	43
Initiating a Hardware Reset on the Modbus Gateway.....	44
Reloading Factory Defaults.....	44
4. UPGRADING THE MODBUS GATEWAY FIRMWARE.....	45
Downloading Firmware Files.....	46
Uploading the Firmware to the Modbus Gateway.....	46
5. DIAGNOSTICS.....	47
Testing a Modbus Gateway Connection.....	47
Monitor Function	48
6. APPLICATION EXAMPLES.....	49
Ethernet Master and Serial Slaves.....	49
Serial & Ethernet Masters, Serial & Ethernet Slaves.....	55
Serial Masters, IP Slaves	57
Identical Hard Coded Slaves.....	63
Identical Production Lines	64
7. MODBUS HELP	65

Modbus ASCII / RTU Basics	65
Hints and Tips.....	66
8. APPENDICES	67
Appendix A: Default Gateway Settings	68
Appendix B: Product Specifications	69
General Specifications.....	70
Controls, Indicators and Connector Specifications.....	71
Serial Interface Specifications.....	72
Network Specifications	72
Appendix C: Dimensional Diagrams.....	73
Appendix D: Connector Pinouts	77
MESR901 Serial Port Pinouts.....	77
MESR902T Serial Port Pinouts.....	78
Standard Ethernet Cable RJ45 Pin-out.....	79
GLOSSARY	80
APPROVALS, DIRECTIVES, STANDARDS	81
ADVANTECH TECHNICAL SUPPORT.....	81

ABOUT THIS DOCUMENT

© 2019 Advantech No part of this publication may be reproduced or transmitted in any form or by any means, electronic or mechanical, including photography, recording, or any information storage and retrieval system without written consent. Information in this manual is subject to change without notice, and does not represent a commitment on the part of Advantech

Advantech shall not be liable for incidental or consequential damages resulting from the furnishing, performance, or use of this manual.

All brand names used in this manual are the registered trademarks of their respective owners. The use of trademarks or other designations in this publication is for reference purposes only and does not constitute an endorsement by the trademark holder.

1. INTRODUCTION

Thank you for purchasing a MESR9xx Modbus Gateway product. This product has been manufactured to the highest standards of quality and performance to ensure your complete satisfaction.



Figure 1. An MESR921-MT Modbus Gateway

ABOUT MESR9xx MODBUS GATEWAYS

MESR9xx Modbus Gateways connect Modbus networks (RS-232, RS-422 or RS-485) to Ethernet networks, allowing the Modbus network to become a node on the network. The serial ports can be accessed over a LAN/WAN using Direct IP Mode connections.

MESR9xx Modbus Gateways feature 10BaseT or 100BaseTX copper network media and fiber optic media options, depending on the model. MESR9xx Modbus Gateways are built for use in industrial environments, featuring an IP30 approved slim-line DIN rail mountable case. They operate from a range of DC power supply voltages and feature pluggable terminal block power connectors. An external power supply, sold separately, is required. MESR90x units have one Ethernet port. MESR92x units have an additional Ethernet port which functions much like an Ethernet Switch.

MESR9xx MODBUS GATEWAYS – NUMBERING MATRIX

MESR9XXX-XX

Number of Ethernet Ports: _____

0 = 1 port

2 = 2 ports

Number of Serial Ports: _____

1 = 1 port

2 = 2 ports

Serial Connector for _____

MESR92x Models:

T = Terminal Block

NOTE: 1/single serial port models have a DB9 or terminal block, which can be wired. (Leave blank for these models.)

Fiber Optic Cable Type:

M = Multi-mode

S = Single-mode (15 km)

NOTE: Not used for copper RJ45. On MESR92x-xx models, the second Ethernet port is always copper RJ45 (Cat 5).

Fiber Optic Connector:

T = ST

C = SC

NOTE: Blank for RJ45 copper.

LIST OF MESR9xx MODBUS GATEWAY MODELS

The following table lists the available MESR9xx Modbus Gateway model configurations.

Model Number	Serial Port/s	Serial Connector	Ethernet Port/s	Ethernet Media	Ethernet Connector/s
MESR901	1	DB9 or TB	1	Copper	(1) RJ-45
MESR902T	2	TB	1	Copper	(1) RJ-45
MESR921	1	DB9 or TB	2	(2) Copper	(2) RJ-45
MESR922T	2	TB	2	(2) Copper	(2) RJ-45
MESR921-MT	1	DB9 or TB	2	MM Fiber, Copper	(1) RJ-45 & (1) ST
MESR922T-SC	2	TB	2	SM Fiber (15 km) & Copper	(1) RJ-45 & (1) SC

MESR9xx MODBUS GATEWAY FEATURES

- Four series:
 - MESR901 (one serial port, one Ethernet Port)
 - MESR902T (two serial ports with pluggable terminal blocks, one Ethernet port)
 - MESR921-x (one serial port, two Ethernet Ports)
 - MESR922T-x (two serial ports with pluggable terminal blocks, two Ethernet Ports)
 - On models with two Ethernet Ports, the second port is an Ethernet pass-through port that functions much like an unmanaged switch.
- Fiber model options – multi-mode or single-mode, SC or ST connectors
- Multi-interface serial ports
- DB9M and/or pluggable terminal block serial port connector options
- All ports are software selectable as RS-232, RS-422 or RS-485 2-wire and 4-wire
- Configuration via network or direct serial connection
- Slim-line, DIN rail mountable case
- Accepts DC power over a wide voltage range
- 10/100 Mbps Ethernet with auto-selection, auto MDI/MDIX
- LAN and WAN communications
- TCP Client or Server operation - configurable
- Firmware upload for future revisions/upgrades
- Software Support: Windows 2000, XP (32/64 bit), 2003 Server (32/64 bit), Vista (32/64 bit), 2008 Server (32/64 bit), 7 (32/64 bit), 8, 10
- Configuration of Ethernet and serial port settings using Vlinx Manager software

VLINX™ MANAGER CONFIGURATION SOFTWARE

The included Vlinx Manager configuration software enables you to find connected Modbus gateways, configure them, upgrade Modbus gateway firmware, and save/load configuration files. It features a Graphical User Interface (“GUI”) that is convenient and easy to use.

2. MESR9xx MODBUS GATEWAY HARDWARE

PACKAGE CHECKLIST

MESR9xx Modbus Gateways are shipped with the following items included:

- MESR9xx Modbus Gateway Module
- Quick Start Guide
- CD with User Manual, Quick Start Guide, Firmware and Configuration Software

MESR9xx MODBUS GATEWAY ENCLOSURES & MOUNTING

Each MESR9xx Modbus Gateway is packaged into one of two similar DIN rail mountable enclosures. Each gateway features LED indicators, power, Ethernet and serial connectors and a recessed mode switch.

NOTE: The MESR921 (shown below) enclosure is larger than an MESR90x unit. See the specification table for enclosure dimensions.



Figure 2. Front View of an MESR921 Modbus Gateway

LED INDICATORS

MESR9xx Modbus Gateways have three types of LED indicators: **Ethernet Link LEDs**, **Ready LED** and **Serial Port LEDs**.



Figure 3. Ready Ethernet Port LEDs on 1 and 2 Ethernet Port Modbus Gateways

E1/E2 ETHERNET LINK LED

The **Ethernet Link** LED (E1 or E2) illuminates (green) if the Ethernet is connected. When the LED is blinking, it indicates that there is data traffic on the Ethernet link.

E1 is used for all models to connect to the network. E2 is used on MESR92x models, and is a pass-through Ethernet connector.

READY LED

The **Ready** LED (green) blinks if the system is operating correctly, once per second in normal operating conditions, or three times per second in reset, configuration mode, or when loading factory defaults. If the LED is off or steady, it indicates the system is *not* operating correctly.

SERIAL PORT LEDS

Model MESR901 Modbus Gateway features one serial port. Model MESR902T Modbus Gateway features two serial ports. Each serial port has an associated LED. Serial Port LEDs blink (green) when data is being transmitted or received on the serial port. When the LED is On, it indicates the serial port is open.

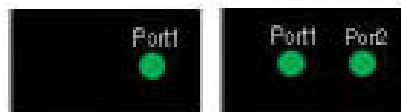

Figure 4. Serial Port LEDs on 1 and 2 Serial Port Modbus Gateways

MODE SWITCH

A recessed momentary reset switch is located on the top of the enclosure. To activate the switch, insert a small plastic tool through the hole in the enclosure and press lightly.

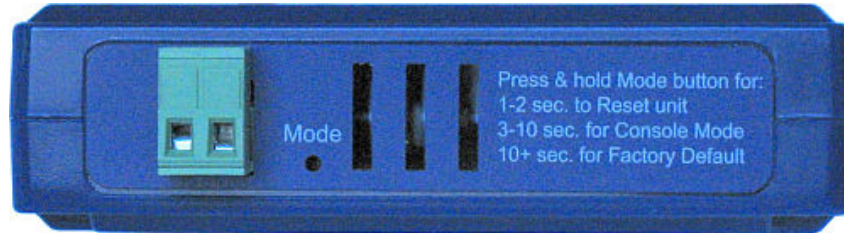

Figure 5. Mode Switch

The Mode switch can be used to:

- Initiate a hardware reset
- Enter Console Mode
- Reload factory defaults

NOTE: Refer to Section 3: Modbus Gateway Setup and Connections for more information on using the Mode switch.

ETHERNET CONNECTOR

Modbus gateway models using 10BaseT/100BaseTX network connections use an RJ45 receptacle. The Modbus gateway is connected to a standard Ethernet network drop using a straight-through RJ45 (male) Ethernet cable.



Figure 6. Ethernet Connectors. E2 is pass-through connection on model shown

NOTE: Refer to Appendix D for connection pin-outs.

FIBER OPTIC CONNECTORS

Modbus gateway models using fiber optic network connections use either SC or ST connectors, depending on the specific model.

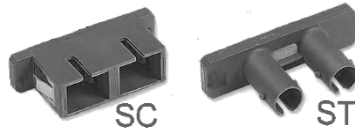

Figure 7. SC and ST Fiber Optic Cable Connectors

SERIAL PORT CONNECTORS

MESR9xx Modbus Gateways use four serial port connector configurations, depending on the model:

- MESR901 Modbus Gateway features one serial port and uses a DB9M connector for RS-232 and a 5-position removable terminal block for RS-422 and RS-485 connections.
- MESR902T Modbus Gateway features two serial ports, both using 5-position removable terminal blocks for RS-232, RS-422 and RS-485 connections.
- MESR921-x Modbus Gateways feature one serial port and use a DB9M connector for RS-232 and a 5-position removable terminal block for RS-422 and RS-485 connections.
- MESR922T-x Modbus Gateways feature two serial ports, both using 5-position removable terminal blocks for RS-232, RS-422 and RS-485 connections.



Figure 8. DB9 Female Serial Port Connector



Figure 9. Five-Position Pluggable Terminal Block

NOTE: Refer to Appendix D for connection pin-outs.

POWER CONNECTOR

The power connector is a 2-position pluggable terminal block.



Figure 10. Power Connection

MOUNTING HARDWARE

MESR9xx Modbus Gateway modules can be DIN rail mounted. The DIN mounting clip and spring is included on each module.



Figure 11. DIN Clips Detail - large DIN clips are used on MESR92x; small DIN clips on MESR90x.

3. MODBUS GATEWAY SETUP & CONNECTIONS

NOTE: In this section, devices to be connected to the Modbus gateway's serial connection are simply referred to as the "Modbus network".

CONNECTING THE POWER SUPPLY

Connect a DC power supply to the power terminals on the top of the Modbus gateway. Polarity of the wires is indicated on the label on the side of the Modbus gateway. Acceptable voltages are between 10 VDC and 48 VDC. The power supply must be capable of supplying 4 Watts for MESR90x units or 6 Watts from MESR92x units.

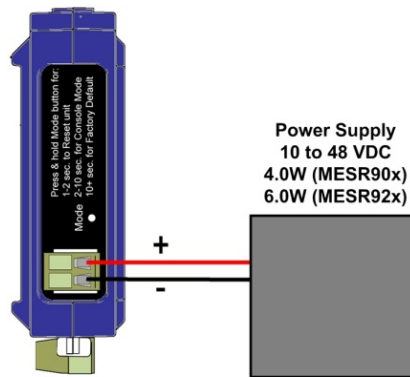

Figure 12. MESR Power Connection

CONNECTING MESR9xx MODBUS GATEWAYS TO MODBUS NETWORKS

MESR9xx Modbus Gateways can be configured to connect to Modbus networks using RS-232, RS-422, RS-485 2-wire and RS-485 4-wire.

RS-232 connections support eight signal lines plus Signal Ground. Signals are single ended and referenced to Ground. Default communications parameters are 9600, 8, N, 1 and no flow control implemented.

RS-422 connections support two signal pairs: RXA(-), RXB(+) and TXA(-), TXB(+), plus GND. The data lines are differential pairs (A & B) in which the B line is positive relative to the A line in the idle (mark) state. Ground provides a common mode reference.

RS-485 connections support 2-wire or 4-wire operation.

When configured for **4-wire operation**, the connection supports two signal pairs: RXA(-), RXB(+) and TXA(-), TXB(+), plus GND. This makes full-duplex operation possible. The data lines are differential pairs (A & B) in which the B line is positive relative to the A line in the idle (mark) state. Ground provides a common mode reference.

When configured for **2-wire operation** the connection supports one signal pair: DataB(+) and DataA(-) signal channels using half-duplex operation. The data lines are differential with the Data B line positive relative to Data A in the idle (mark) state. Ground provides a common mode reference.

The **MESR9x1-x** has one serial connection that supports RS-232, RS-422 and RS-485 (2- and 4-wire). The unit has two connectors: a DB9M connector and a 5-position terminal block.

If you select RS-232 mode when you configure the Modbus gateway, you must connect the Modbus serial network to the Modbus gateway via a serial cable. Model MESR901 is DTE. If the Modbus network is DTE, use a null modem (cross-over) cable. If the Modbus network is DCE, use a straight-through cable. DTE and DCT ports are complementary, the **Output** signals on a DTE port are **Inputs** to a DCE port; **Output** signals on a DCE port are **Inputs** to a DTE port. The signal names match each other and connect pin-for-pin. Signal flow is in the direction of the arrows. See figure below.

Modem Cable - Straight Cable DB9 to DB9

DTE Device (Computer)			DTE to DCE Connections		DCE Device (Modem)		
Pin#	DB9	RS-232 Signal Names			Pin#	DB9	RS-232 Signal Names
#1	Carrier Detector (DCD)	CD	←		#1	Carrier Detector (DCD)	CD
#2	Receive Data (Rx)	RD	←		#2	Receive Data (Rx)	RD
#3	Transmit Data (Tx)	TD	→		#3	Transmit Data (Tx)	TD
#4	Data Terminal Ready	DTR	→		#4	Data Terminal Ready	DTR
#5	Signal Ground/Common (SG)	GND	→		#5	Signal Ground/Common (SG)	GND
#6	Data Set Ready	DSR	←		#6	Data Set Ready	DSR
#7	Request to Send	RTS	→		#7	Request to Send	RTS
#8	Clear to Send	CTS	←		#8	Clear to Send	CTS
#9	Ring Indicator	RI	←		#9	Ring Indicator	RI
Soldered to DB9 Metal - Shield					Soldered to DB9 Metal - Shield		
		FGND					FGND

If you select RS-422 mode, RS-485 2-wire mode, or RS-485 4-wire mode when you configure the Modbus gateway, you must connect the Modbus network appropriately, via the 5-position terminal block.

NOTE: Refer to Appendix D for connector pin out information.

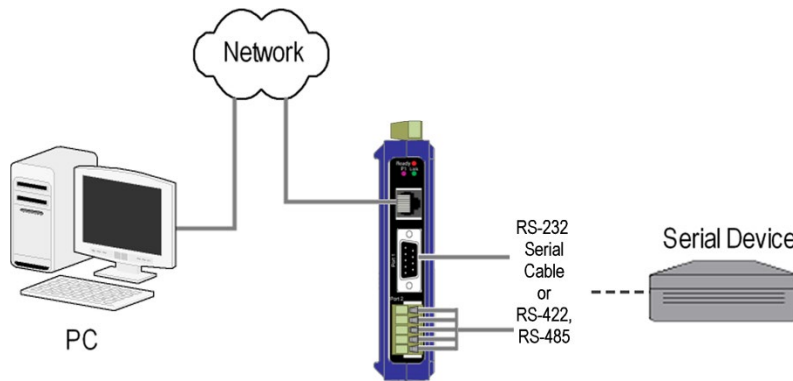

Figure 13. MESR901 Connections

CONNECTING THE MESR9x2T-X

The **MESR9x2T-xx** has two serial connections that support RS-232, RS-422 and RS-485 (2-wire and 4-wire). The unit has two connectors - both are 5-position terminal blocks. Make the appropriate connections to the terminal blocks to match the serial connection mode that you select when configuring the Modbus gateway.

NOTE: Refer to Appendix D for connector pinout information.

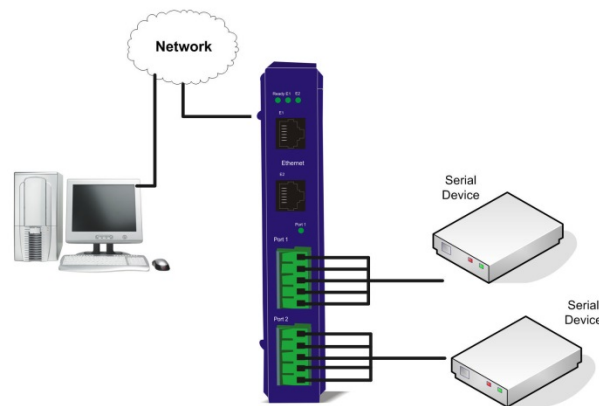

Figure 14. MESR902T Connections

CONNECTING MESR9xx MODBUS GATEWAYS TO A NETWORK

NETWORK CONNECTION (10BASET/100BASETX)

When connecting a Modbus gateway equipped with a 10BaseT/100BaseTX network connection (RJ45 connector), a standard network cable is connected from the Modbus gateway to a network drop. PCs configuring and/or communicating with the Modbus gateway are also connected to the network.

FIBER OPTIC CONNECTION

When connecting a Modbus gateway equipped with a fiber optic interface to a fiber optic link, the appropriate fiber optic cable must be connected between the Modbus gateway and the network interface. Refer to Figure 2, "List of xx Modbus Gateway Models" at the beginning of this manual for a list of supported fiber types, distances and connectors.

MESR9xx MODBUS GATEWAY CONFIGURATION CONNECTIONS

MESR9xx Modbus Gateways can be configured over the network or via a serial port.

INSTALLING MODBUS CONFIGURATION MANAGER SOFTWARE

1. The Modbus Configuration Manager Software is contained on the CD which is packaged with the product. Insert the CD into your CD ROM drive. The software should automatically begin the installation process. If AUTO RUN is disabled on your computer, open the CD drive and double-click on the executable file. The file name is Modbus Gateway Manager Vx.x.x.
 - a. The following screen will be displayed on your computer:

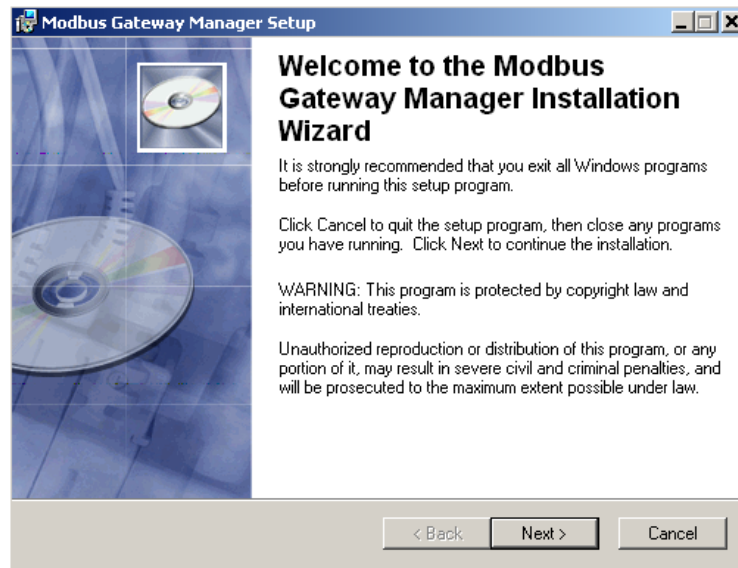

Figure 15. *Modbus Gateway Manager Installation Welcome Screen*

- b. Click **Next**. The License Agreement Screen will be displayed on your computer.

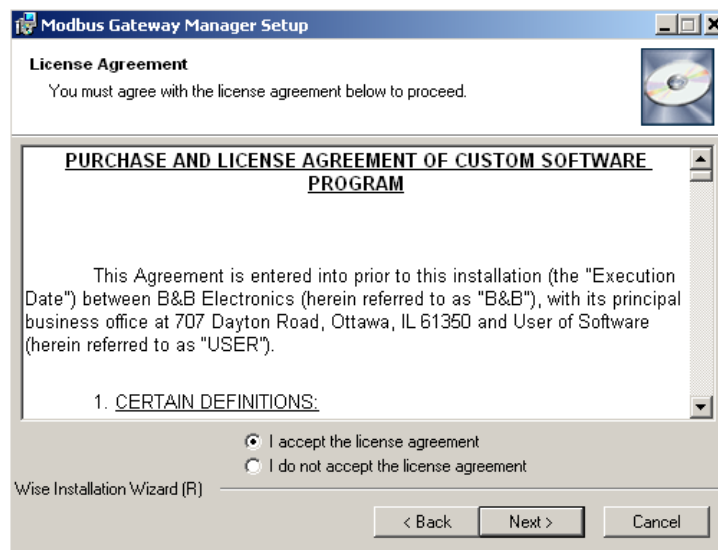

Figure 16. *Modbus License Acceptance Screen*

- c. Click **Next**. The User Information Screen will be displayed on your computer. Enter your name and organization (optional) and select if the software will be accessible to your account or anyone who uses the computer.

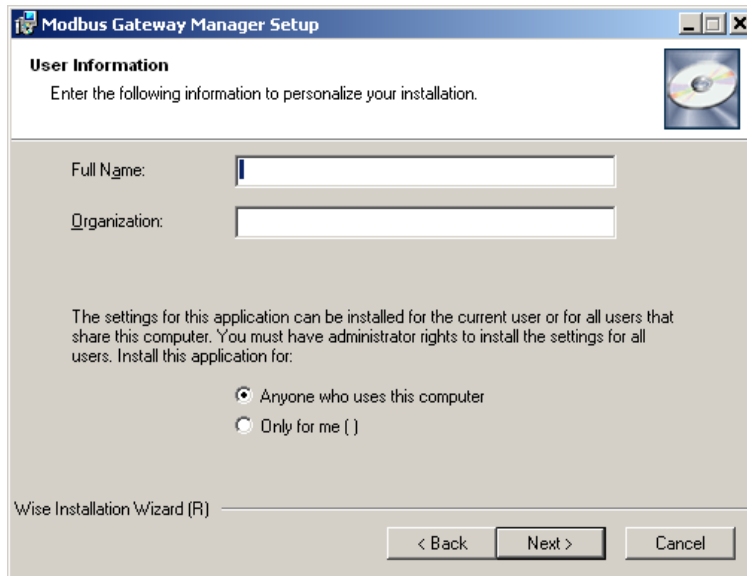

Figure 17. User Information Screen

- d. Click **Next**. The Destination Folder Screen will be displayed on your computer. The default directory is:

C:\Program Files\BB Electronics\Winx\Modbus Gateway Manager\

If desired, you can select another location by clicking the **Browse** button.

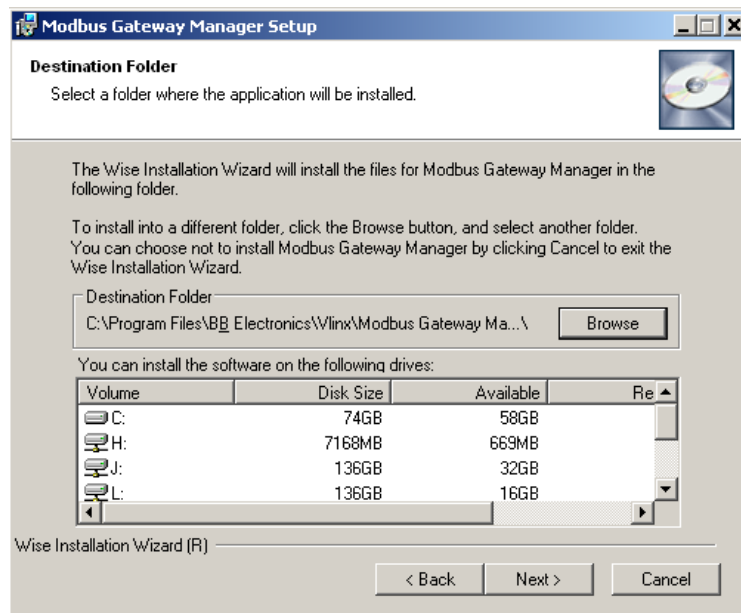

Figure 18. Destination Folder Screen

- e. Click **Next**. The Ready to Install Application Screen will be displayed on your computer. You can select the **Back** button to change destination folder.

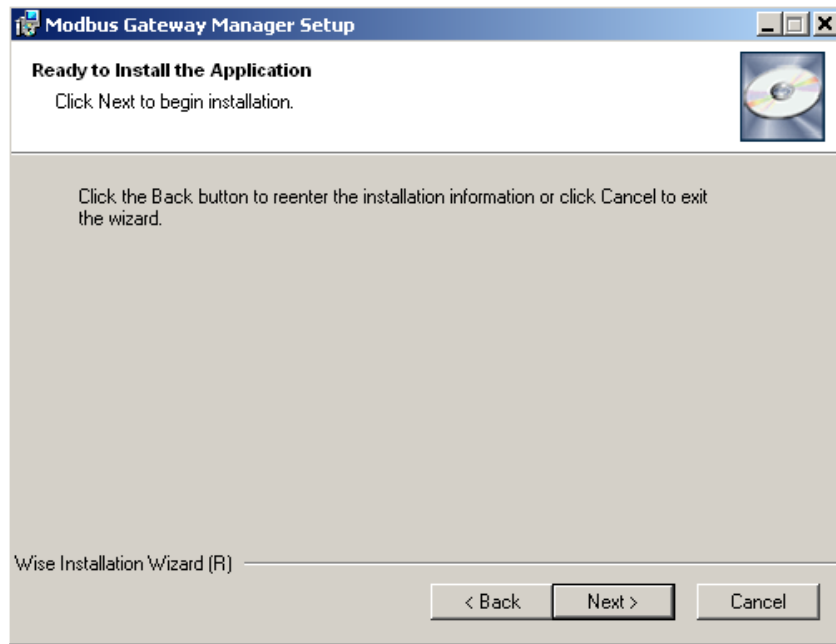

Figure 19. Ready to Install Application Screen

- f. Click **Next**. The software will begin installing.

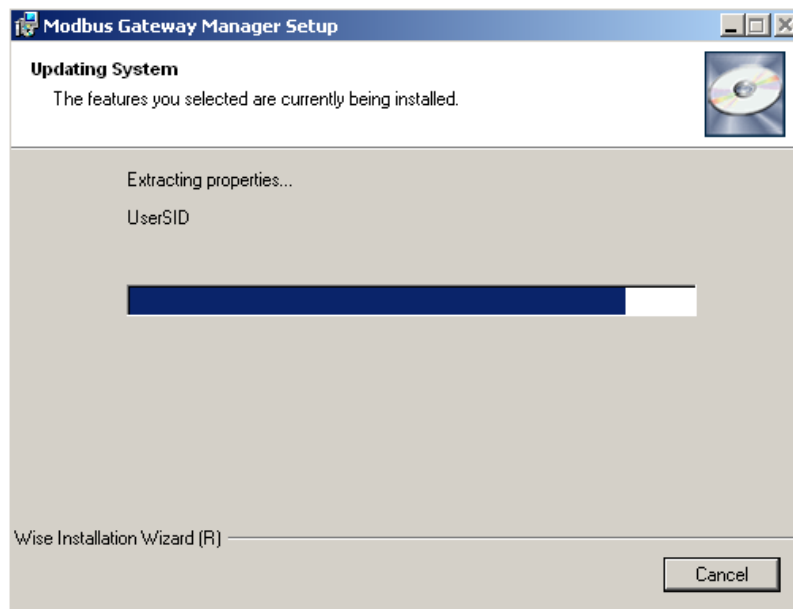

Figure 20. Software Installing Screen

- g. After the installation is complete, an information screen will be displayed containing contact information and release notes. Click **Next**.

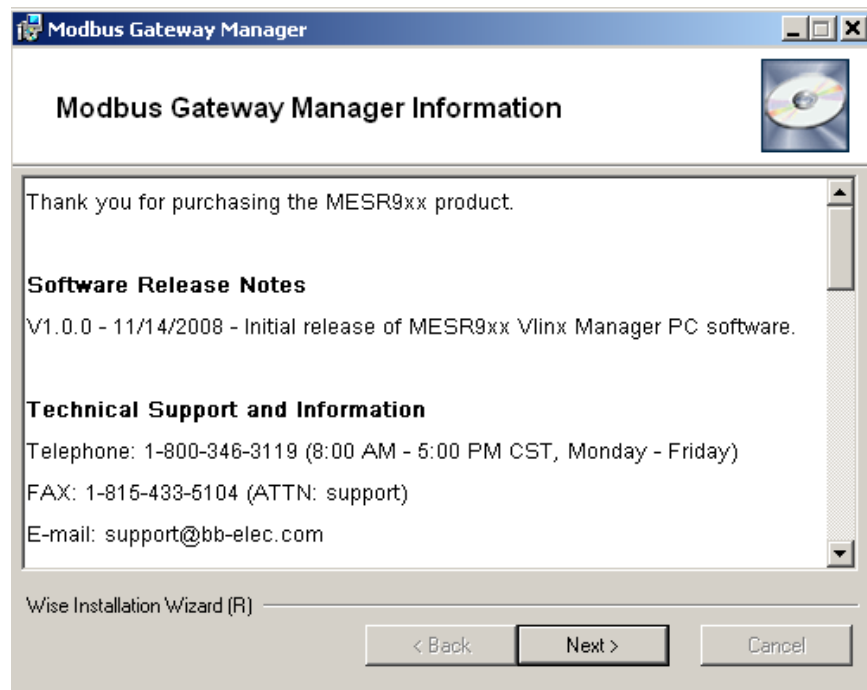

Figure 21. Information Screen

- h. Click **Next**. The Installation Complete screen will be displayed on your computer. Click **Finish** to finish the installation.



Figure 22. Installation Complete Screen

CONFIGURING THE GATEWAY VIA THE NETWORK CONNECTION

When configuring via the network, either Modbus Configuration software or the web interface can be used.

CONFIGURING WITH MODBUS CONFIGURATION MANAGER

MESR9xx Modbus Gateways can be configured over the network using Modbus Configuration manager software running on a PC.

To open Modbus Configuration Manager:

1. From the Desktop, click **Start → Programs → Advantech → Vlinx → Modbus Gateway Manager**. Alternate method: double-click the shortcut installed on the desktop.

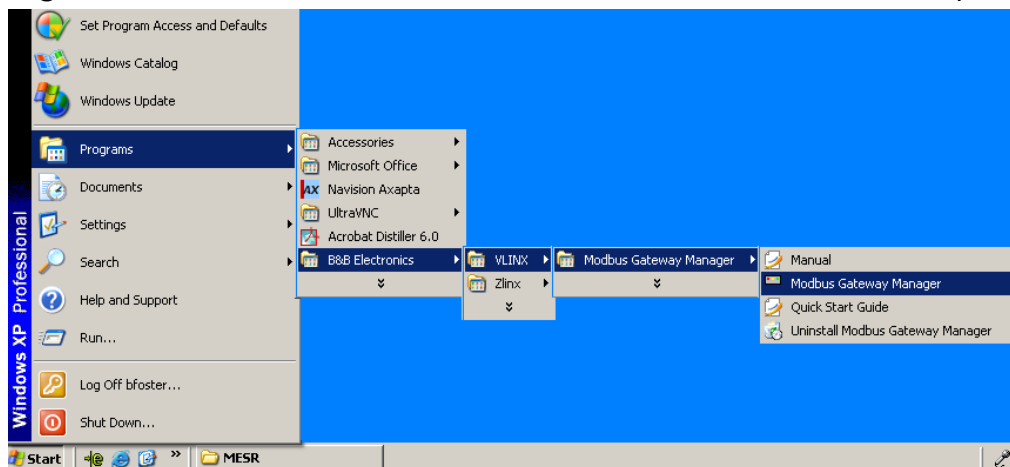

Figure 23. Opening Vlinx Modbus Gateway Manager



Figure 24. Vlinx Modbus Gateway Manager Shortcut Icon

- The Vlinx Modbus Configuration Manager Device Discovery window appears.

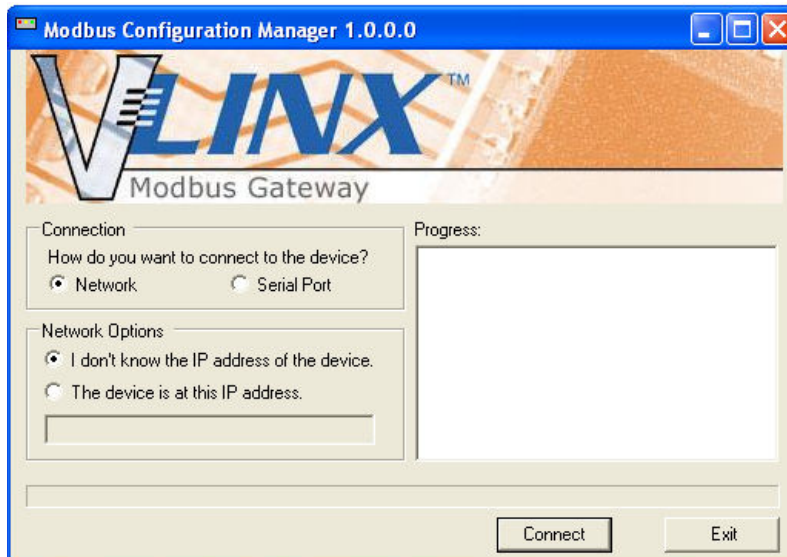

Figure 25. Vlinx Modbus Configuration Manager Discovery Window

- If you do not know the IP address, check **Network** and **I don't know the IP address of this device** selections and click the **Connect** button. The software will discover any MESR9xx Gateways on the network. The configuration manager screen will be displayed on your computer. All available devices will be listed on the top portion of this screen. If you know the IP address, you may select **The Device is located at this IP address** and input the address in the box provided.

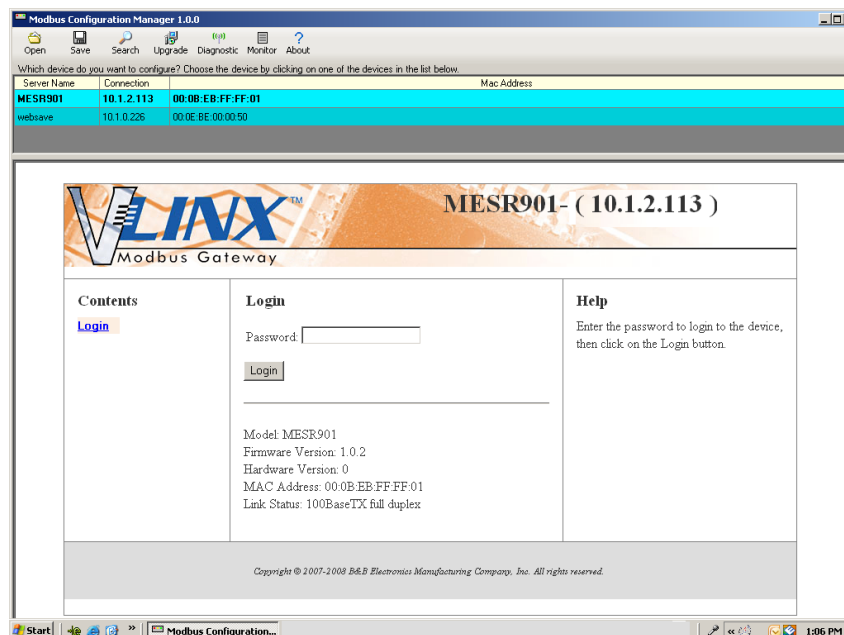

Figure 26. Configuration Manager Screen

4. All Modbus Gateways on the network will be displayed in the top portion of the screen. To select a gateway, click the appropriate device.
 - a. The main portion of the screen displays the Model, Firmware version, Hardware version, MAC Address, and Link Status. The IP Address is also displayed on the top portion of the screen and title graphic area.
5. The default password is no password. Click the **Login** button. The “General” settings screen will be displayed on your computer.
6. Vlinux Modbus Manager Settings Screen Overview:

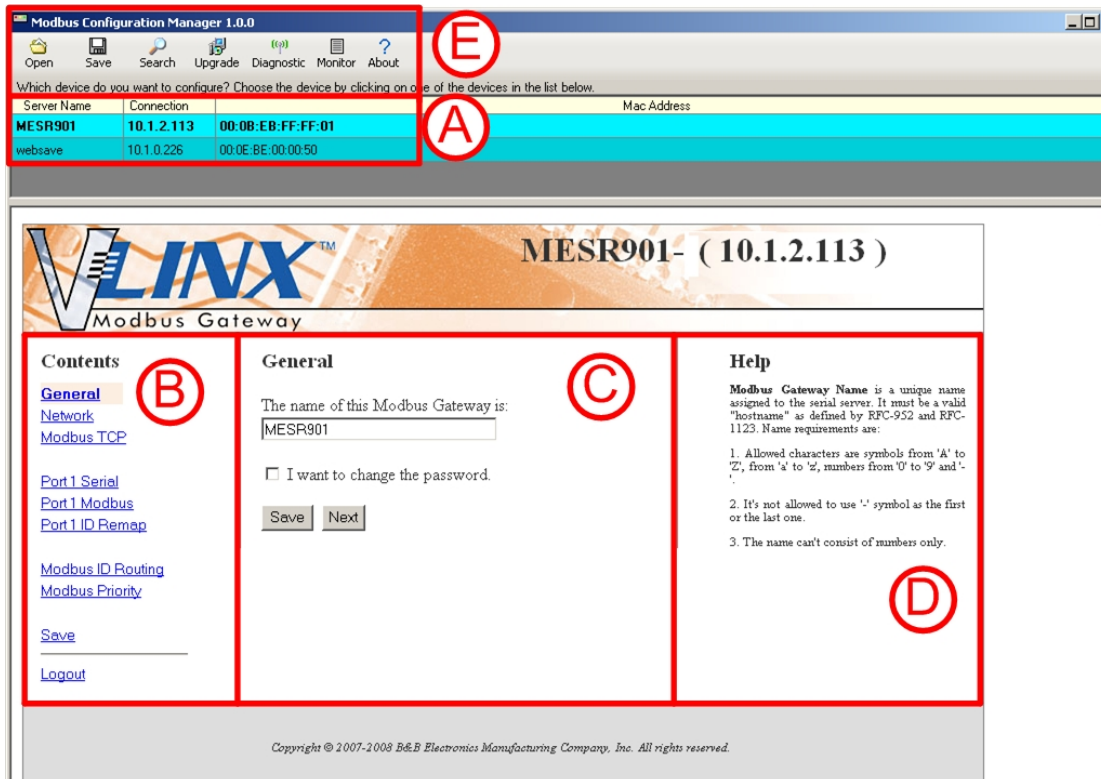

Figure 27. Settings Screen Overview

- a. This area shows Modbus Gateways available on the network.
- b. This area is used to skip directly to the specific configuration screen that you need to access. An alternate method of accessing the configuration screens is to use the **Next** button in area C.
- c. This area contains dialog boxes specific to the configuration screen.

NOTE: Any configuration changes you make must be saved using the **Save** button.
- d. This area contains helpful information about the configuration screen you are currently on.
- e. This area contains shortcuts to specific functions:
 1. **Open** allows you to load a previously saved configuration file into your Modbus Gateway.
 2. **Save** allows you to save your configuration to a file. This should not be confused with the “Save” button described in 6.c above.

3. **Search** allows you to search for Modbus Gateways on the network.
4. **Upgrade** allows you to upgrade your Modbus Gateway's firmware.
5. **Diagnostic** allows you to test a configured Modbus Gateway. See Section 5.
6. **Monitor** allows you to monitor a Modbus Gateway. See Section 5.
7. **About** contains information about your Modbus Gateway.

7. General Settings:

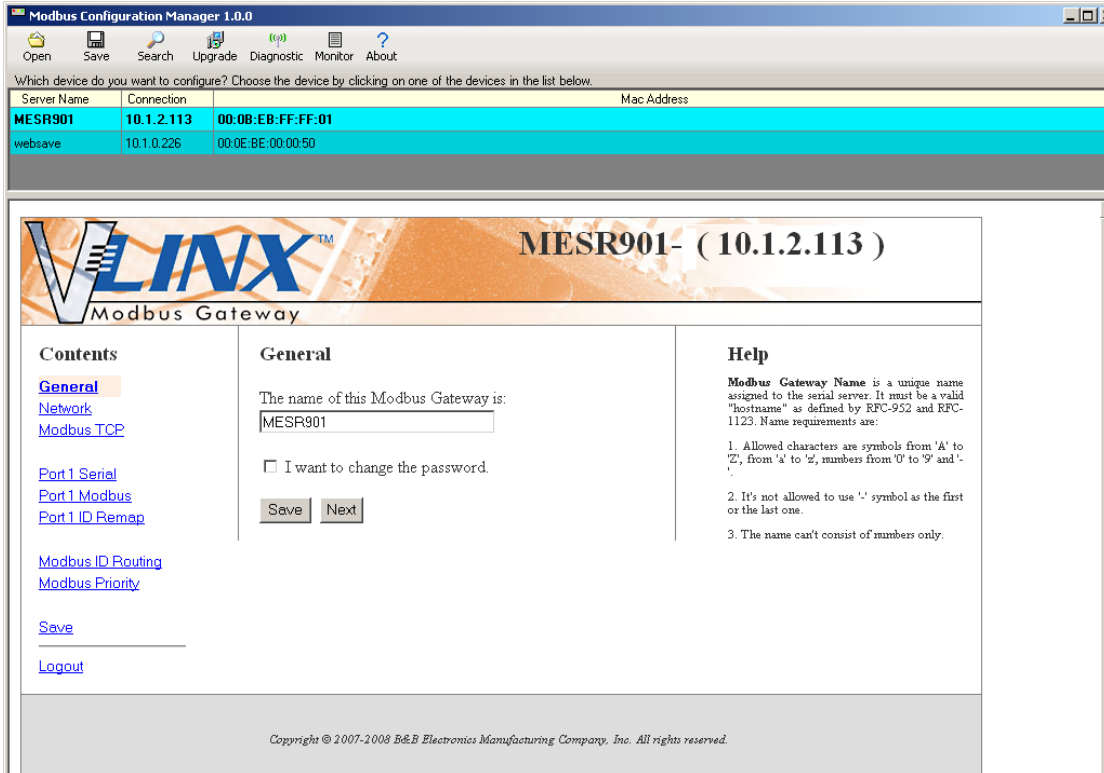

Figure 28. General Settings Screen

- a. This screen enables you to assign a unique name to the gateway. This allows you to easily identify a particular gateway when multiple devices are used on the same network. To change the name, type a new name in the "The Name of this Modbus Gateway is" box. The name must be a valid "hostname" as defined by RFC-952 and RFC-1123. Allowed characters are A to Z, a to z, 0 to 9 and "-". The "-" symbol cannot be the first or last character. The name cannot consist of numbers only. **To save the new name, click the Save button.**
- b. You can also change the gateway's password on this screen. To do this, check the **I want to change the password** box. New password entry boxes will appear on the screen.

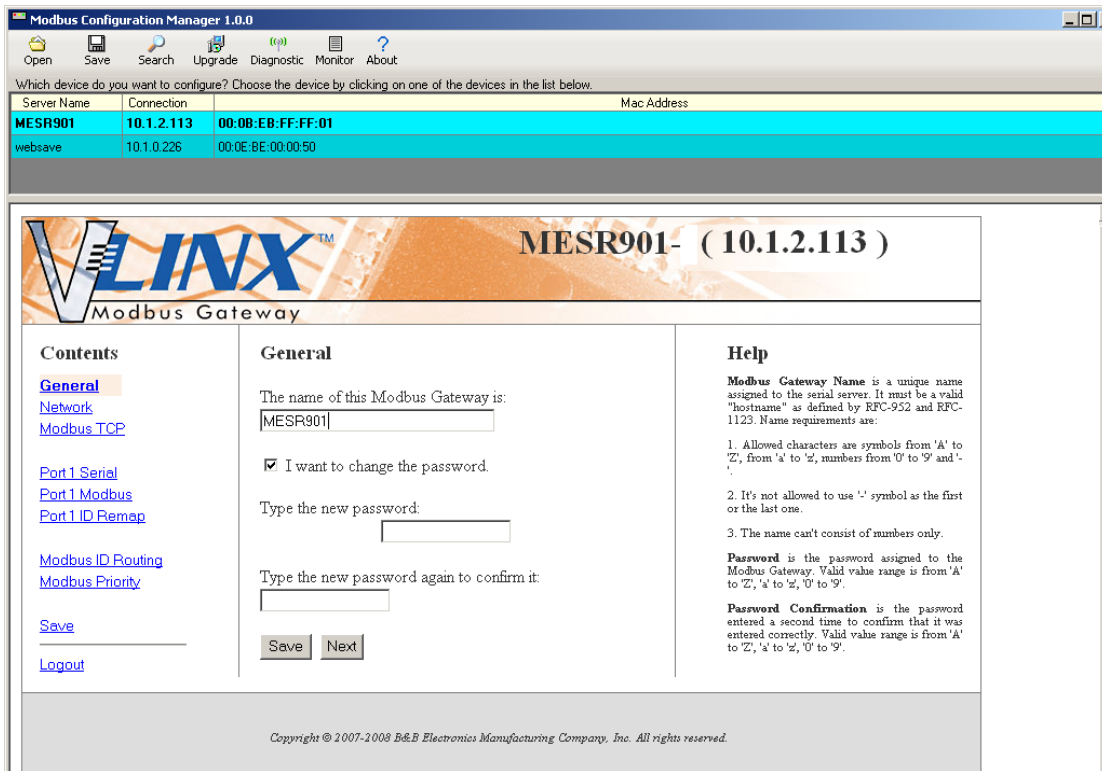

Figure 29. Changing The Password

- c. Type your new password in the “Type the new password box.” Verify the password by typing it again in the box provided. **To save the new password click the “Save” button.**

8. Network Settings

- a. To get to the Network Settings Screen, you can either click the **Next** button or click on the **Network** link on the left side of the screen.



Figure 30. Network Settings Screen (DHCP Selected)

- b. The default network configuration is to receive an IP address assignment from a DHCP Server. **DHCP** controls whether or not a DHCP server is used to set the IP address, subnet mask and default gateway of the Modbus Gateway. When DHCP option is enabled but the DHCP Server is not found, the Modbus Gateway will automatically configure IP address 1169.254.255.255 with a subnet mask 255.255.0.0
- c. To configure your Modbus Gateway without using a DHCP server, uncheck the **I want DHCP to setup the network** box. You will need to know the IP Address, Subnet Mask, and Default Gateway.

IP Address field contains static internet protocol address of the Modbus Gateway.

Subnet Mask field contains mask that is used to define sub network.

For Class A network (IP addresses 0.0.0.0 through 127.255.255.255), the default subnet mask is 255.0.0.0.

For Class B network (IP addresses 128.0.0.0 through 191.255.255.255), the default subnet mask is 255.255.0.0.

For Class C network (IP addresses 192.0.0.0 through 223.255.255.255), the default subnet mask is 255.255.255.0.

For Class D network (IP addresses 224.0.0.0 through 239.255.255.255) and Class E network (IP addresses 240.0.0.0 through 255.255.255.255), the subnet mask is ignored.

Default Gateway field contains default route to remote networks.

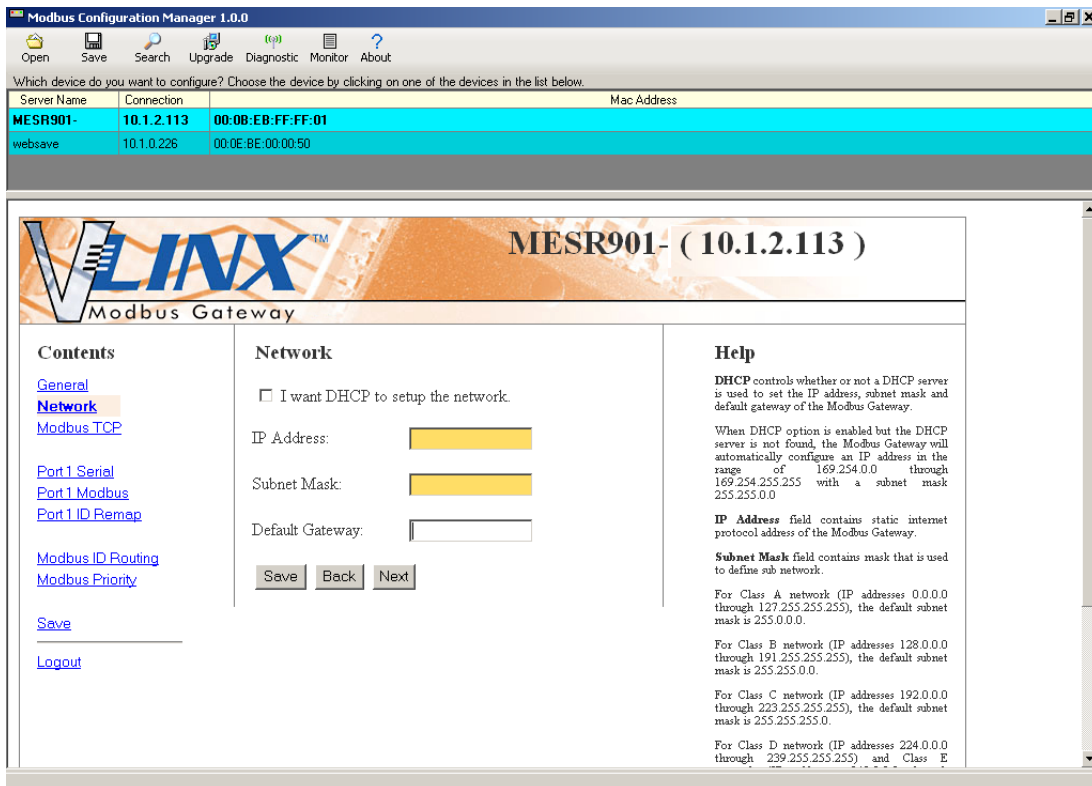

Figure 31. Network Settings Screen (DHCP not selected)

- d. More information about assigning an IP address without using a DHCP Server is contained in the section, "Configuring the VESR90x Serial Server on Networks without a DHCP Server."
- e. Save changes by clicking the **Save** button.

9. Modbus TCP Settings

- a. To access this screen, click the **Next** button or click on the Modbus TCP link on the left side of the screen.
- b. This screen allows you to change Modbus TCP client and server settings.

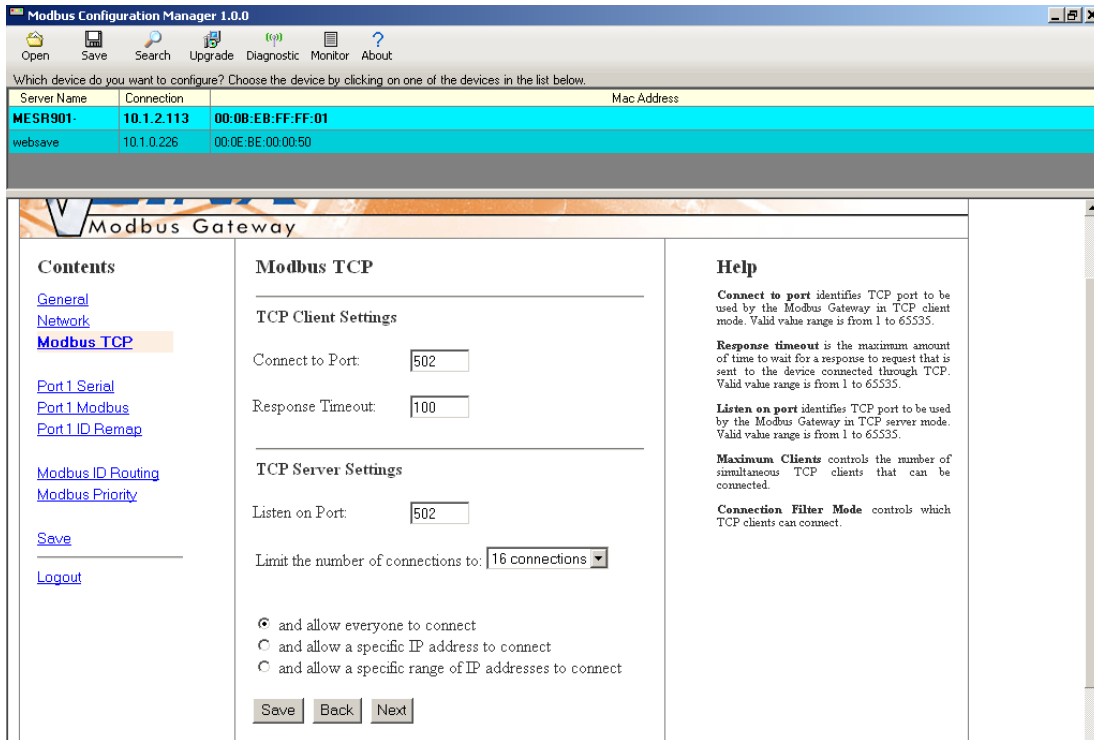

Figure 32. Modbus TCP Settings Screen

c. TCP Server Settings

- i. **Connect to Port** identifies TCP port to be used by the Modbus Gateway in TCP client mode. Valid value range is from 1 to 65535.
- ii. **Response Timeout** is the maximum amount of time to wait for a response to a request that is sent to the device connected through TCP. Valid value range is from 1 to 65535.
- iii. Save settings by clicking the **Save** button.

d. TCP Server Settings

- i. **Listen on Port** identifies TCP port to be used by the Modbus Gateway in TCP server mode. Valid value range is from 1 to 65535.
- ii. **“Limit the number of connections to_”** pull down box allows you to control the number of simultaneous TCP clients that can be connected. Choices are 1 through 16.
- iii. **Connection Filter Mode** controls which TCP clients are able to connect. The default is: “and allow everyone to connect.”
 - a. You can select **“allow a specific IP address to connect.”** This filter is limited to 4 IP addresses.

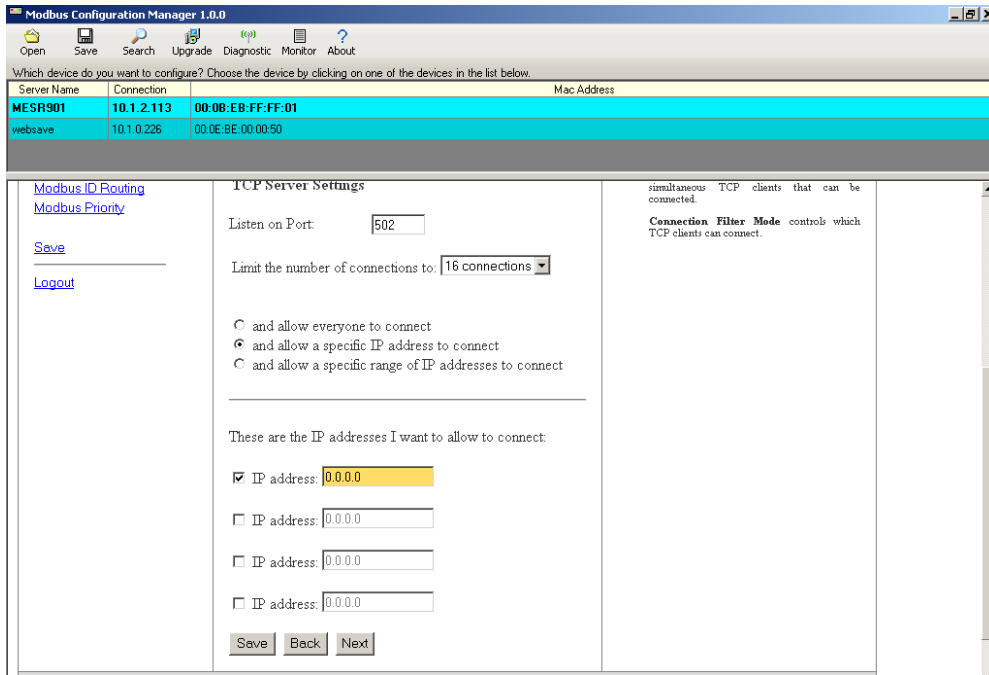

Figure 33. TCP Connection Filter “Allow Specific IP addresses to Connect”

- You can select **and allow a specific range of IP addresses to connect**. This filter is limited to 4 IP address ranges.
- Save settings by clicking the **Save** button.

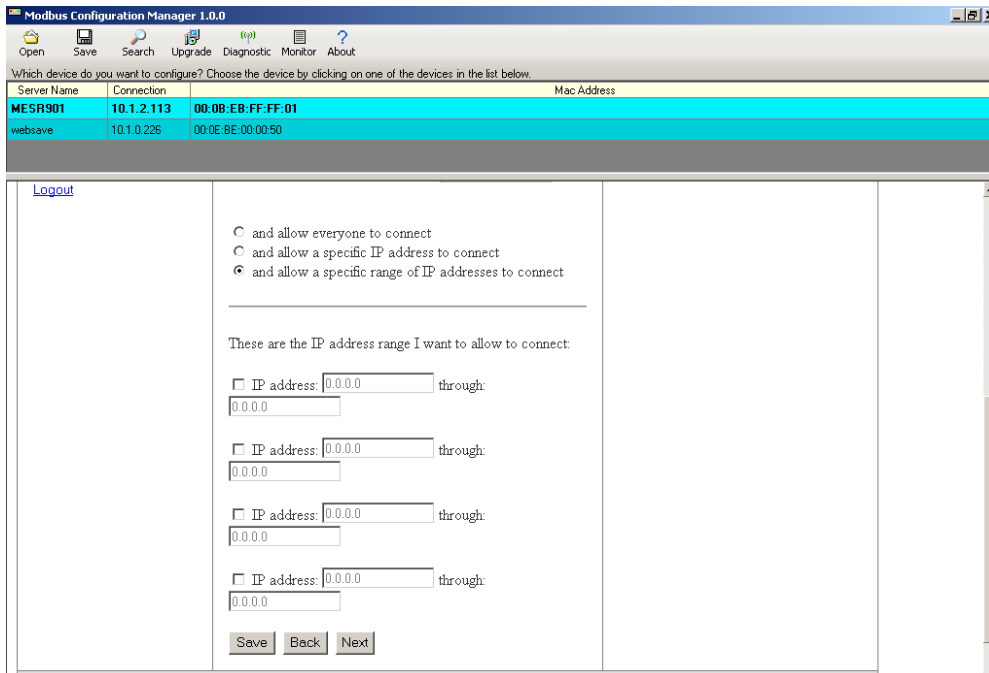

Figure 34. TCP Connection Filter “Allow Specific Range of IP Addresses to Connect”

Figure 35.

10. PORT x Serial Settings

- a. To access this screen, click the **Next** button or click the Port X Serial link on the left side of the screen. X = the Serial Port number (1 or 2)
- b. This screen allows you to change the serial port settings.

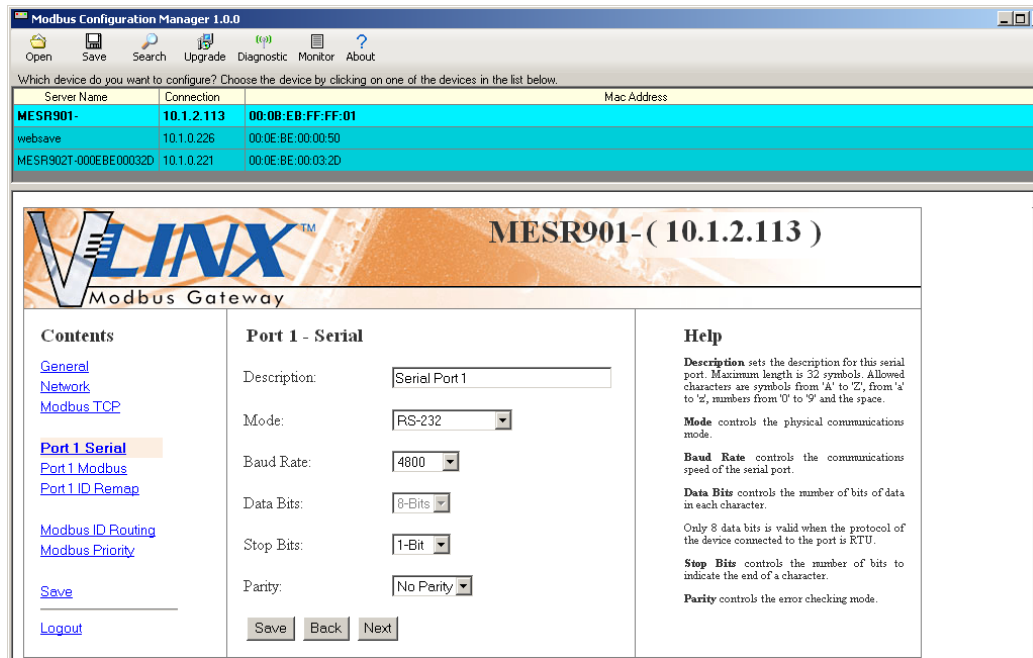

Figure 36. Serial Port Screen

- c. **Description** - sets the description for this serial port. Maximum length is 32 symbols. Allowed characters are symbols from 'A' to 'Z', from 'a' to 'z', numbers from '0' to '9' and the space.
- d. **Mode** – Controls the physical communications mode for the. The Mode can be RS-232, RS-422 (4-Wire), RS-485 (2-Wire), or RS-485 (4-Wire).
- e. **Baud Rate** – Controls the communications speed of the serial port. The Baud Rate can be: 2400, 7200, 9600, 14400, 19200, 14400, 28800, 38400, 57600, 115200, or 230400.
- f. **Stop Bits** – Controls the number of bits to end a character. Choices are 1 or 2.
- g. **Parity** – Controls the error checking mode. Choices are Odd, Even, Mark, or Space.
- h. Save settings by clicking the **Save**” button.

11. Port X Modbus

- a. To access this screen, click the **Next** button or click the **Port X Modbus** link on the left side of the screen. X = the Serial Port Number (1 or 2)
- b. This screen allows you to change Modbus settings for the port.

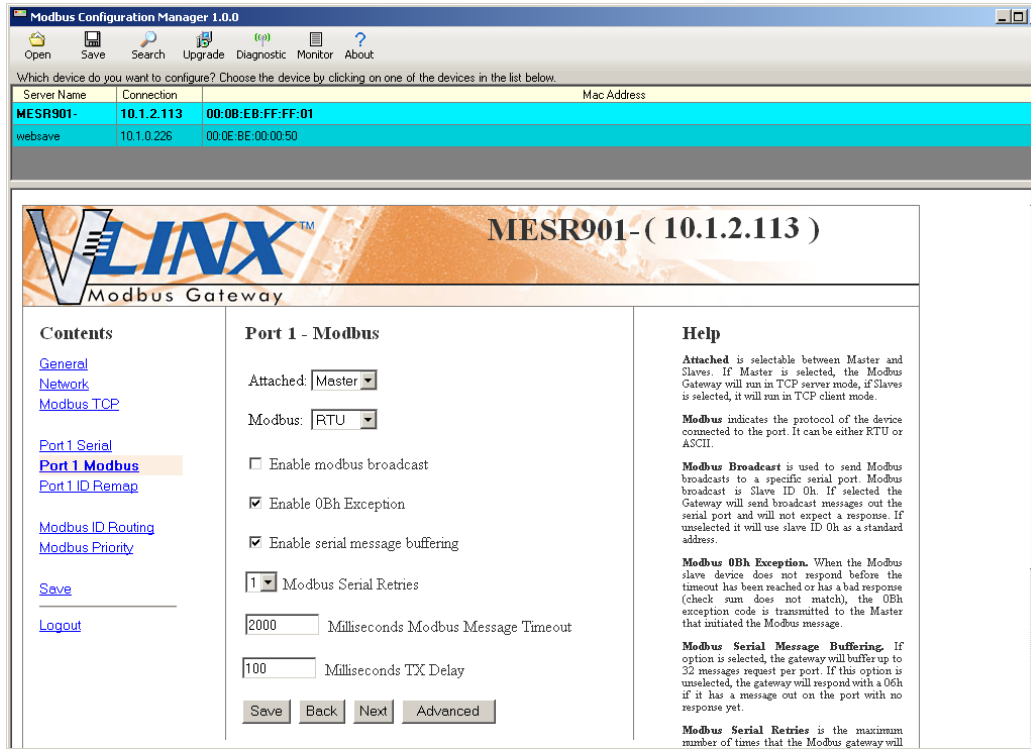

Figure 37. Modbus Port Screen

- c. **Attached** – This is selectable between Master and Slaves. If Master is selected, the Modbus Gateway will run in TCP server mode; if Slaves is selected, it will run in TCP client mode.
- d. **Modbus** – indicates the protocol of the device connected to the port. It can be either RTU or ASCII.
- e. **Modbus Broadcast** – Check this box to send Modbus broadcasts to a specific serial port. Modbus broadcast is Slave ID 0h. If selected, the Gateway will send broadcast messages out the serial port and will not expect a response. If unselected it will use slave ID 0h as a standard address.
- f. **Enable 0Bh Exception** – Check this box to enable. When the Modbus slave device does not respond before the timeout has been reached or has a bad response (check sum does not match), the 0Bh exception code is transmitted to the Master that initiated the Modbus message.
- g. **Enable Serial Message Buffering** – If this option is selected, the gateway will buffer up to 32 messages request per port. If this option is unselected, the gateway will respond with a 06h if it has a message out on the port with no response yet.

- h. **Modbus Serial Retires** – Select 0 through 5. This sets the maximum number of times that the Modbus gateway will retry to send a Modbus message to a Modbus client, before reporting a 0Bh exception if it is selected. Number of retries is limited to 5.
 - i. **Milliseconds Modbus Message Timeout** – This is the maximum amount of time to wait for a response to the message. Valid value range is from 1 to 65535.
 - j. **Milliseconds TX Delay** – This is the minimum amount of time after receiving a response before the next message can be sent out. Valid value range is from 1 to 65535.
 - k. Save settings by clicking the **Save**” button.
12. Port x ID Remap
- a. To access this screen, click the **Next** button or click the **Port x ID Remap**” link on the left side of the screen.
 - b. This screen allows you to set Modbus Slave ID Remap settings.

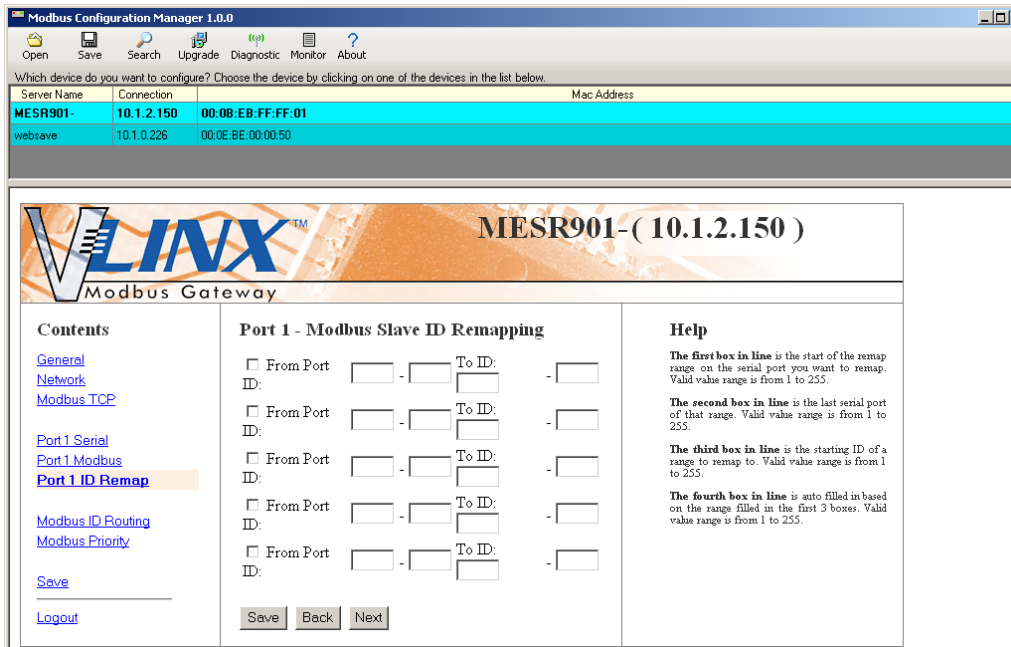

Figure 38. Port ID Remap Screen

- c. The first box in line is the start of the remap range on the serial port that you want to remap. Valid value range is from 1 to 255.
- d. The second box in line is the last serial port of that range. Valid value range is from 1 to 255.

- e. The third box in line is the starting ID of a range to remap to. Valid value range is from 1 to 255.
 - f. The fourth box in line is auto-filled in based on the range filled in the first 3 boxes. Valid value range is from 1 to 255.
 - g. Save settings by clicking the **Save** button.
13. Modbus ID Routing
- a. To access this screen, click the **Next** button or click the **Modbus ID Routing** link on the left side of the screen.
 - b. This screen allows you to set the Modbus Slave ID routing.

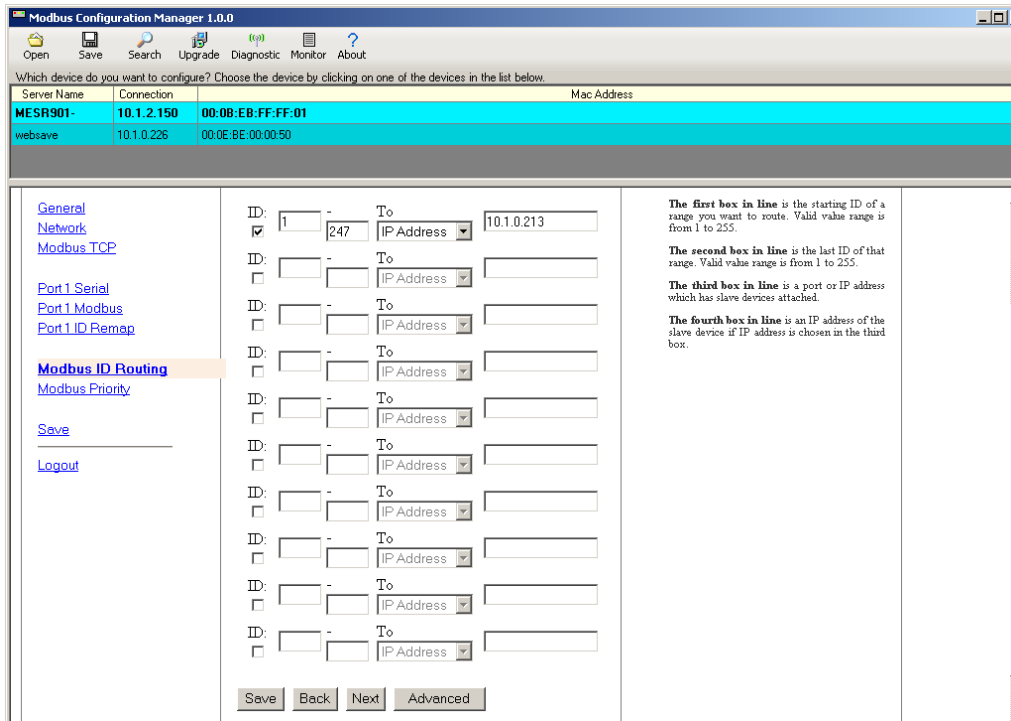

Figure 39. Modbus ID Routing Screen

- c. The first box in line is the starting ID of a range you want to route. Valid value range is from 1 to 255.
- d. The second box in line is the last ID of that range. Valid value range is from 1 to 255.
- e. The third box in line is a port or IP address which has slave devices attached.
- f. The fourth box in line is an IP address of the slave device if IP address is chosen in the third box.
- g. Save settings by clicking the **Save** button.

14. Modbus Priority

- a. To access this screen, click the **Next** button or click the **Modbus Priority** link on the left side of the screen.
- b. This screen allows you to configure the gateway to move high priority messages to the front of the serial message buffer.

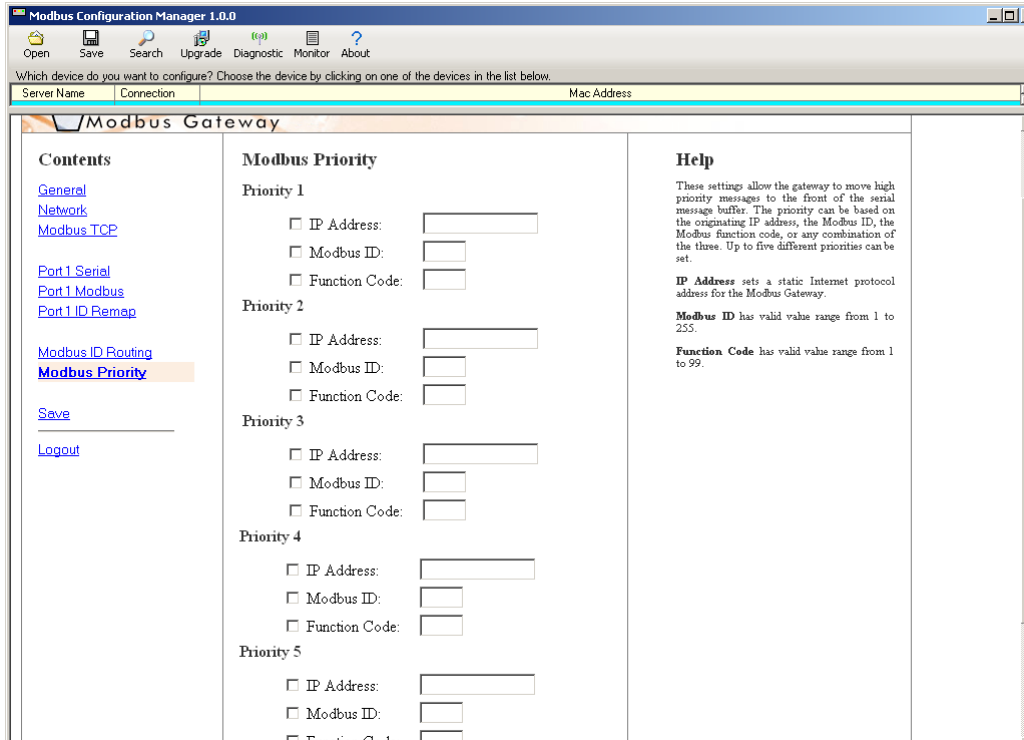

Figure 40. Modbus Priority Screen

- c. These settings allow the gateway to move high priority messages to the front of the serial message buffer. The priority can be based on the originating IP address, the Modbus ID, the Modbus function code, or any combination of the three. Up to five different priorities can be set.
- d. **IP Address** – Used to set a static Internet protocol address for the Modbus Gateway.
- e. **Modbus ID** – Valid range is from 1 to 255.
- f. **Function Code** – Valid range is from 1 to 99.
- g. Save settings by clicking the **Save** button.

NOTE: For more information on configuration options refer to Section 4, "Description of Modbus Gateway Properties."

CONFIGURING WITH THE WEB INTERFACE

MESR9xx Modbus Gateways can be configured over the network using a standard internet browser such as Internet Explorer or Firefox.

To open the web configuration interface:

1. On a PC connected to the network, open a web browser.

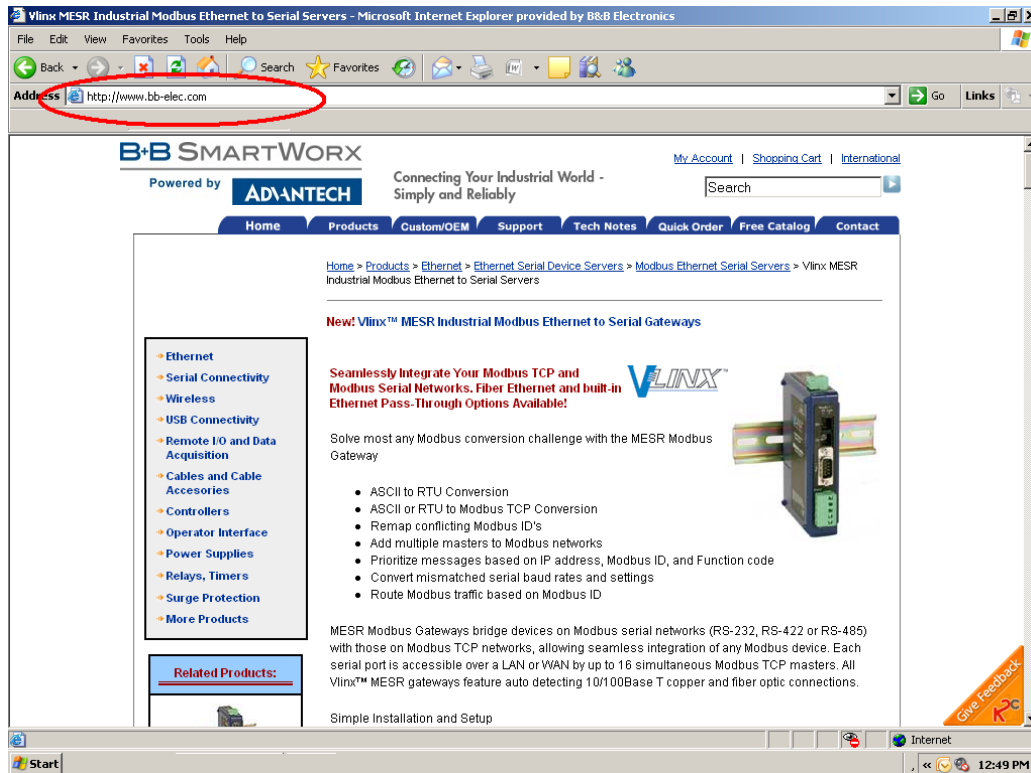

Figure 41. Open Web Browser

2. In the browser's address bar, type the IP address of the Modbus gateway.

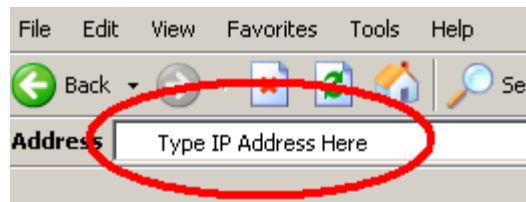

Figure 42. Type IP Address

NOTE: Your Modbus gateway is factory pre-configured to receive an IP address assignment from a DHCP server. If a DHCP server is not available on your network, it will default to 169.254.102.39.

The web interface Login page appears.

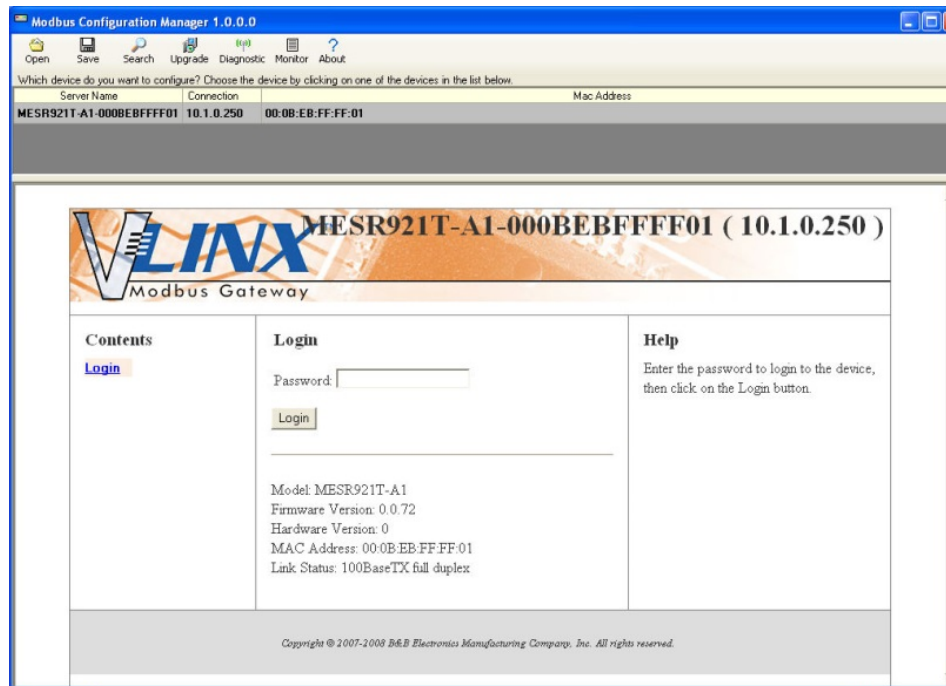

Figure 43. Modbus Gateway Login Screen

3. The screens for configuring your gateway via a web browser are the same as those used to configure using the Vlinx Modbus Manager software.

CONFIGURING THE MESR9xx MODBUS GATEWAY ON NETWORKS WITHOUT A DHCP SERVER

Your Modbus Gateway comes factory-set to receive an IP assignment from a DHCP server. If there is not a DHCP server on your network, the Modbus Gateway will default to IP address **169.254.102.39**. If this address does not work with your PC, there are two methods to manually configure the network information:

1. **Method 1:** Change your PC Network to Match the Modbus Gateway

Open your network connection:

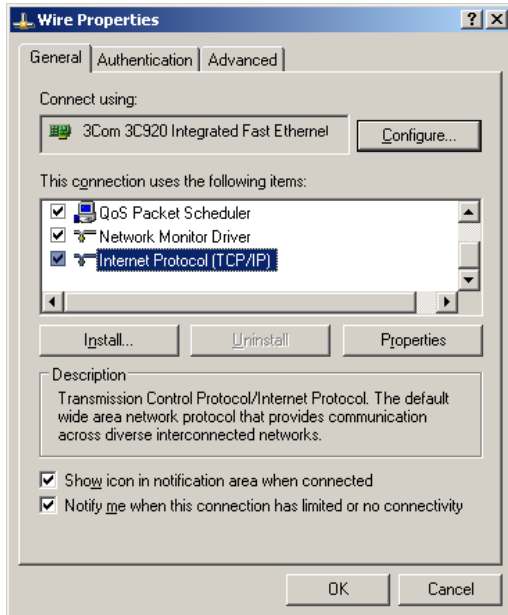

b. Click on Internet Protocol (TCP/IP) and click <Properties>. Change the parameters to the following:

IP Address = 169.254.102.1
 Subnet Mask = 255.255.0.0
 Default Gateway = 169.254.102.100

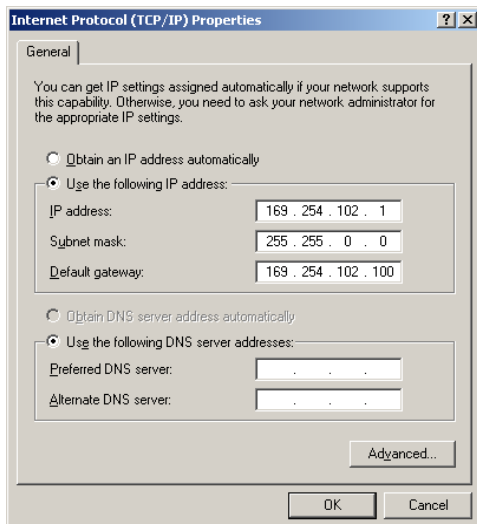

c. Use the Vlinx™ Modbus Manager Software to search for, discover, and configure the Modbus Gateway.

2. **Method 2:** Change the Modbus Gateway's network settings to match your PC using Console Mode:

- a. Connect a null modem serial cable (crossover cable) from Port 1 on the Modbus Gateway to an available COM port on your PC.
- b. Open Hyper Terminal or similar serial emulation software and connect to the COM port used in Step 1. Ensure the port is configured to: 115,200 baud, 8 data bits, no parity, and 1 stop bit.
- c. Enter Console Mode. Press and hold the Modbus Gateway's reset button for 2 to 10 seconds. The LED indicators will respond as follows:

Model	Port 1 LED	Port 2 LED	Ready LED
MESR9x1	OFF	XXXXXXX	ON
MESR9x2	OFF	ON	OFF

- d. Release the reset button. The READY LED will blink once per second for five seconds. This indicates that the Modbus Gateway is re-booting in Console Mode.
- e. When the Modbus Gateway has successfully restarted in Console Mode, the READY LED will be OFF and the PORT 1 LED will be ON.
- f. Open the Vlinx™ Modbus Manager Software and select **Serial Port** as the method to connect to the Modbus Gateway.
- g. After logging in, click on <Network>.
- h. Un-check the box next to **I Want DHCP to set up the Network**.
- i. Re-configure the Modbus Gateway's network settings to something within the range of your PC's network settings. For example:

PC Network Settings:

IP Address = 192.168.0.1
 Subnet Mask = 255.255.0.0
 Default Gateway = 192.168.0.100

Change the Modbus Gateway's network settings to:

IP Address = 192.168.0.50
 Subnet Mask = 255.255.0.0
 Default Gateway = 192.168.0.100

- j. Save the settings and remove power from the Modbus Gateway.
- k. Re-apply power. Open the Vlinx™ Modbus Manager Software and select **Network** as the method to connect to the device.

CONFIGURING THE MESR9xx MODBUS GATEWAY VIA THE SERIAL PORT (CONSOLE MODE)

Your Modbus gateway can be configured via a serial port using Vlinx™ Modbus Manager. To use this feature, the Modbus Gateway's serial port must be connected to the serial port of a PC (using a null modem cable).

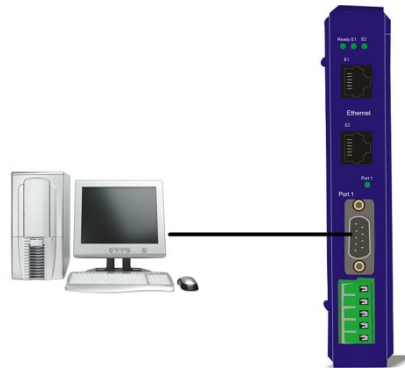

Figure 44. Console Mode Setup

To configure the Modbus Gateway, it must be put into Console Mode, using the Mode switch.

To enter Console Mode, press and hold the Mode switch for between 2 and 10 seconds. The LED indicators respond as follows:

1. The Ready LED blinks three times per second while the button is being pressed.
2. The Modbus gateway is in Console Mode when:
 - On Model MESR901: Port 1 LED is On and the Ready LED is Off.
 - On MESR902T: Port 1 LED is On and the Port 2 LED is Off.

To configure the Modbus Gateway, open the Vlinx Modbus Manager software and set up the Modbus gateway's parameters as required.

1. Under Connection, select **Serial Port**.

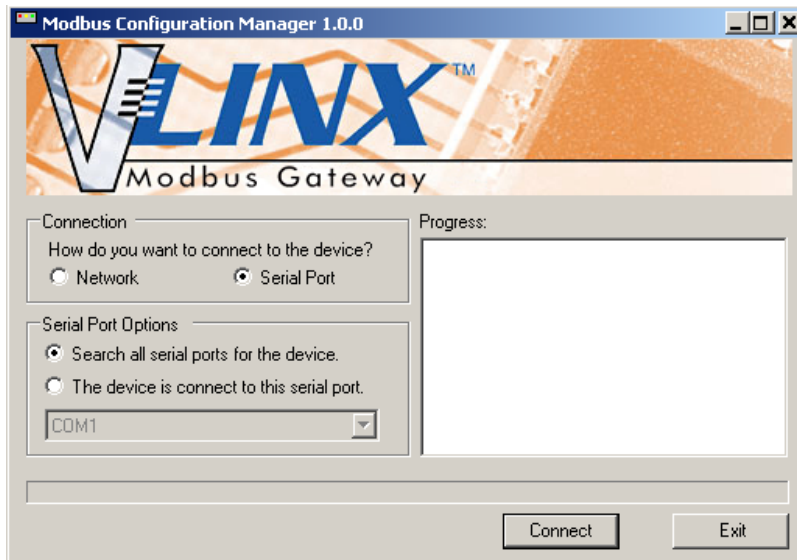

Figure 45. Connection

2. If you do not know which COM port your gateway is connected to, select **Search all serial ports for the device** under Serial Port Options. If you do know, you may specify the COM port by selecting **The device is connected to this serial port** under Serial Port Options and using the pull down menu to choose the COM port.

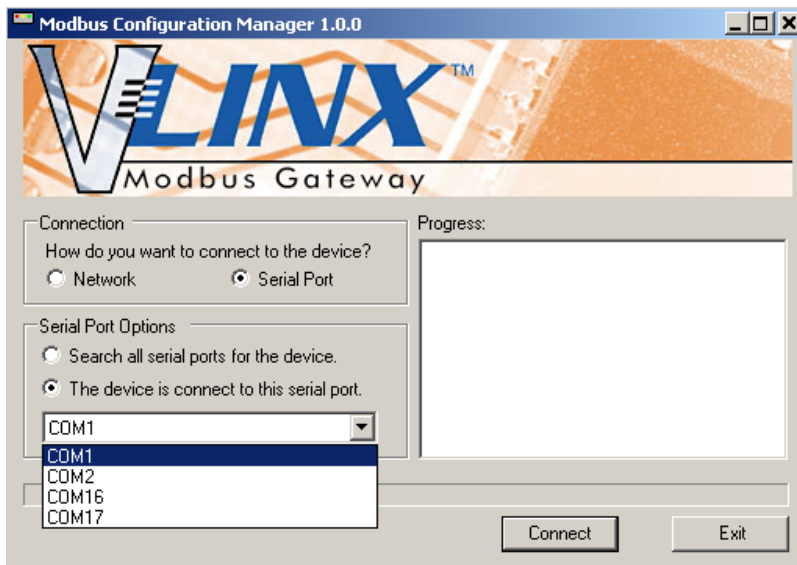

Figure 46. Serial Port Selection

3. The remaining screens are identical to those shown in configuring your gateway using a network connection.

To exit Console Mode, press and hold the Reset switch for two seconds. The LEDs go back to their normal states when the device resumes normal operation.

MESR9xx MODBUS GATEWAY OPERATIONAL CONNECTIONS

MESR9xx Modbus Gateways can operate in Direct IP Mode.

USING MESR9xx MODBUS GATEWAYS IN DIRECT IP MODE

A Direct IP connection allows applications using TCP/IP socket programs to communicate with the COM ports on the Modbus gateway. In this type of application, the Modbus gateway is configured as a TCP server. The socket program running on the PC establishes a communication connection with the Modbus gateway. The data is sent directly to and from the serial port on the server.

To set up a Direct IP Mode connection:

1. Connect the Modbus gateway to the network and a Modbus network as described in previous sections.
2. Configure the Modbus gateway with the appropriate network settings (using Vlinx™ Modbus Manager or the web interface).
3. Configure your software application with the appropriate IP address and port number to communicate with the Modbus network(s).

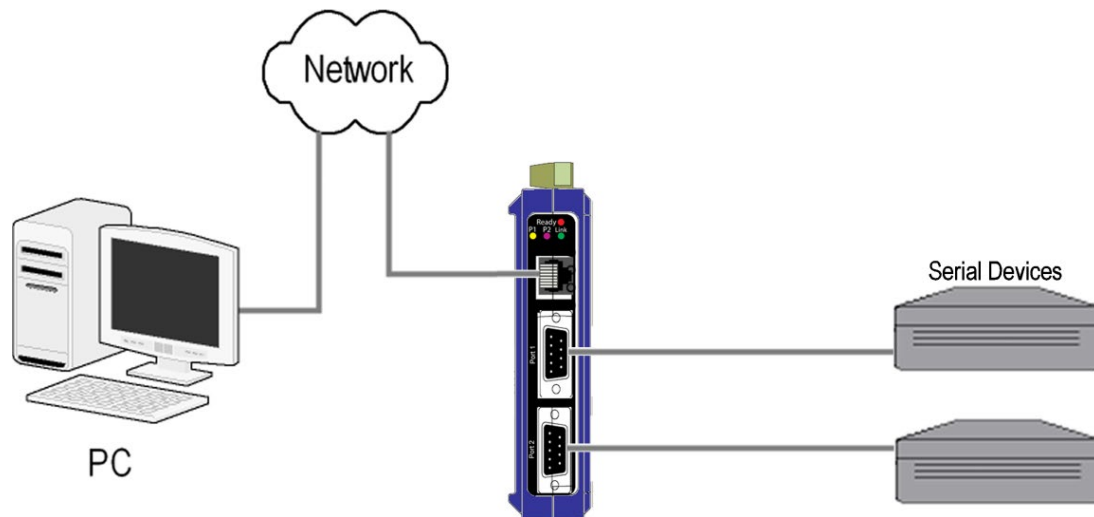

Figure 47. Direct IP Connection

INITIATING A HARDWARE RESET ON THE MODBUS GATEWAY

To initiate a Hardware Reset on the Modbus Gateway, press and hold the Mode switch for 0 to 2 seconds, then release it. The LED indicators respond as follows:

1. The Ready LED blinks three times per second while the button is being pressed.
2. The Modbus Gateway is in Reset Mode when:
 - On Model MESR901: Port 1 LED is On and the Ready LED is Off.
 - On MESR902T: Port 1 LED is On and the Port 2 LED is Off.
3. The LEDs go back to their normal states when the device resumes normal operation.

RELOADING FACTORY DEFAULTS

To reload Factory Defaults, press and hold the Mode switch for more than 10 seconds. The LED indicators respond as follows:

1. The Ready LED blinks three times per second while the button is being pressed.
2. The Modbus gateway is in Factory Default Mode when:
 - On Model MESR901: Port 1 LED and the Ready LED are both On.
 - On MESR902T: Port 1 LED and the Port 2 LED are both On.

The Modbus gateway reloads all factory default configuration parameters.

3. The LEDs go back to their normal states when the device resumes normal operation.

NOTE: Factor default parameters are listed in Appendix A.

4. UPGRADING THE MODBUS GATEWAY FIRMWARE

Occasionally, updated firmware may become available for your Modbus Gateway. The firmware can be upgraded using the Zlinux™ Manager software. The following procedure describes the firmware updating process:

1. Click the **Upgrade** button to open the **Firmware Upgrade** dialog box.

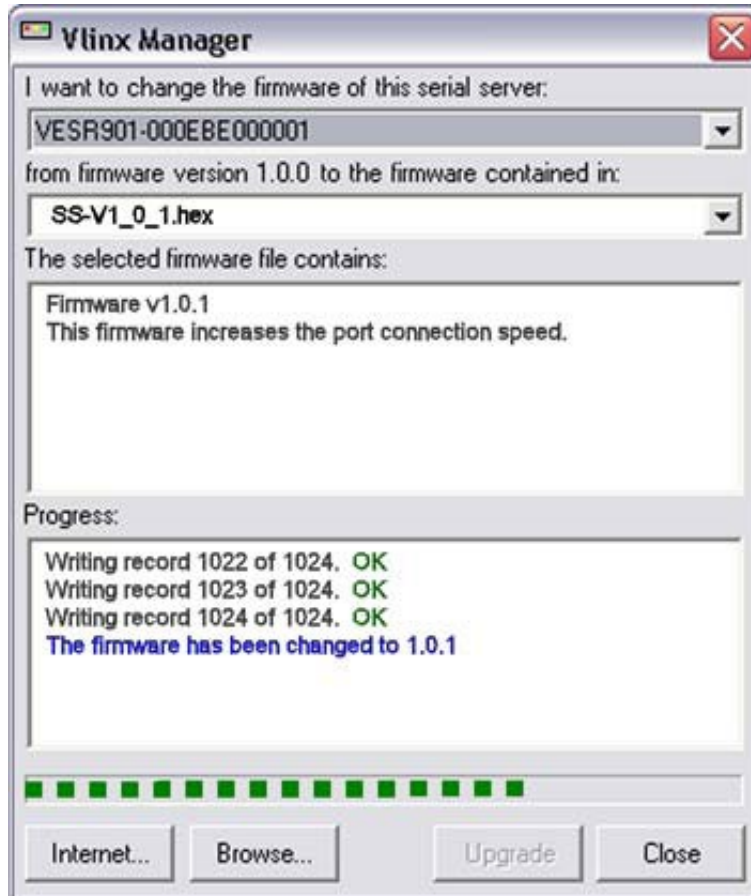

Figure 48. Firmware Upgrade Dialog Box

The name of the currently selected Modbus gateway appears in the top drop down list. Other Modbus gateways (that have already been discovered) can be selected from the drop down list, if desired.

The current firmware version of the selected Modbus gateway is shown in the text below the Modbus gateway name.

Information about the selected firmware file is shown in the third text box.

DOWNLOADING FIRMWARE FILES

The **Firmware File** list (second box) displays all firmware files in the firmware installation folder. Only firmware that is compatible with the selected Modbus gateway is available in this list.

To download the latest firmware files from an FTP site on the Internet:

1. Click the **Internet** button at the bottom of the window.

The Vlinx™ Modbus Manager connects to an FTP server on the Internet.

2. Click the **Check for Updates** button.

Progress Bar and **Progress Box** display information about and progress of the download.

To download the latest firmware files from a file:

1. Click the **Browse** button to open an **Open File** dialog box.
2. Browse to the drive and folder containing the firmware file.
3. Select and download the file to the local firmware folder.

UPLOADING THE FIRMWARE TO THE MODBUS GATEWAY

To upgrade the firmware:

1. In the **Modbus Gateway Selection** drop down list, select the Modbus gateway to be upgraded.
2. In the **Firmware Description** drop down list, select the firmware to upload to the Modbus gateway.
3. Click the **Upgrade** button.

Progress Bar and **Progress Box** provides information on the progress of the transfer.

4. In the **Firmware File** drop down list, select the firmware file to upload to the Modbus gateway.
5. Click **Upgrade**. The Progress box and Progress bar display information on the upgrading process.
6. When the upgrade process is complete, click **Close**.

5. DIAGNOSTICS

Clicking the **Diagnostics** icon opens the **Diagnostics** dialog box and enables you to check the operation of connected Modbus gateways on the local computer.

The **Computer Information** box displays information about the type of network connections, the IP Addresses, Subnet Masks and Default Gateways in use.

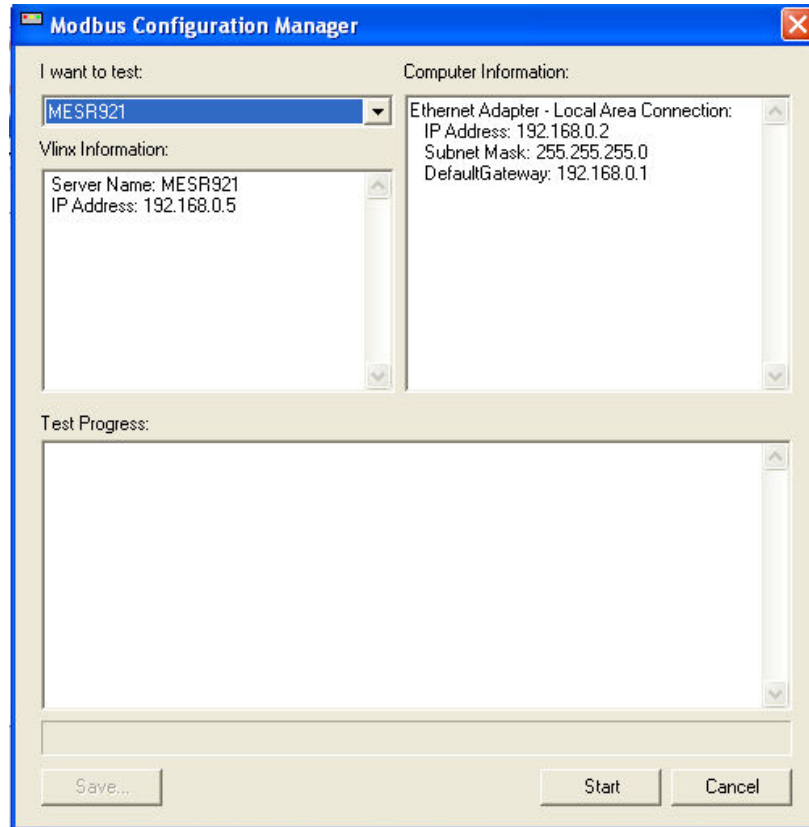

Figure 49. Diagnostics Dialog Box

TESTING A MODBUS GATEWAY CONNECTION

To run diagnostics on a Modbus gateway:

1. Click the **Diagnostics** icon.

The **Diagnostics** dialog box appears.

2. In the drop down box select the specific Modbus gateway that you want to check.
3. Click the **Start** button

Information about the progress of the pinging process is displayed in the **Test Progress** box.

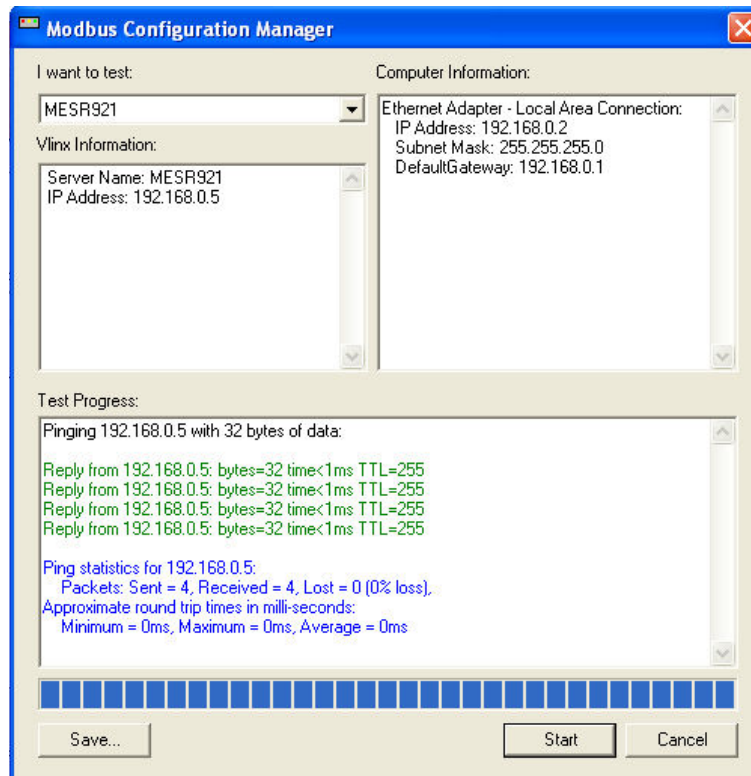

Figure 50. Testing a Modbus Gateway Connection

MONITOR FUNCTION

The Monitor button is used to display a screen that shows information about events and data transfer through the Modbus Gateway.

To start monitoring, select a Modbus Gateway and press the “**Start**” button.

The “**Auto Scroll**” check box enables and disables automatic scrolling of the displayed text.

The “**Clear**” button clears the displayed text.

Press the “**Stop**” button to stop monitoring.

Press the “**Save**” button to save the information to a file.

6. APPLICATION EXAMPLES

Modbus Gateways can be used to integrate Modbus networks in a wide variety of settings. But, as each setting has its own requirements, users may not understand how a gateway helps, or if it is appropriate for their specific needs.

The following scenarios are examples only, and many others are possible. Contact Advantech technical support for information on other applications.

ETHERNET MASTER AND SERIAL SLAVES

Your Modbus Gateway can be used to integrate serial slave devices on a Modbus TCP network. This allows TCP Masters to control serial slave devices. The example below is using a gateway with two serial ports.

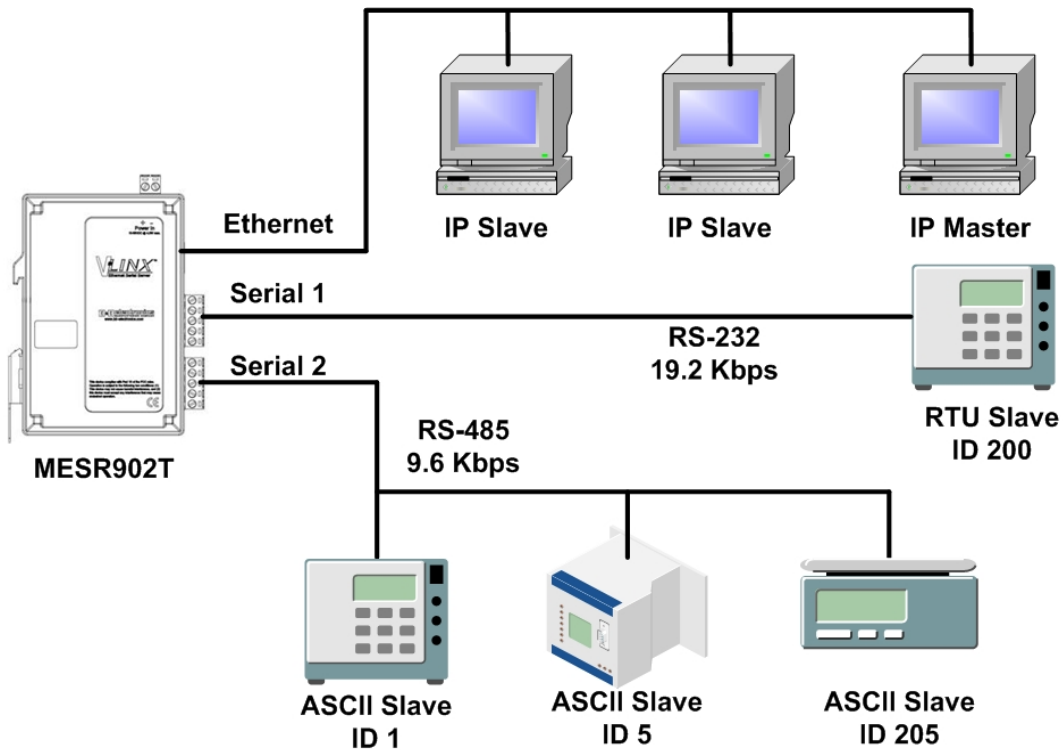

Figure 51. Ethernet Master With Serial Slaves

1. Log into your gateway.
2. Access the Serial Port 1 setup screen by clicking the link on the left side of the screen.

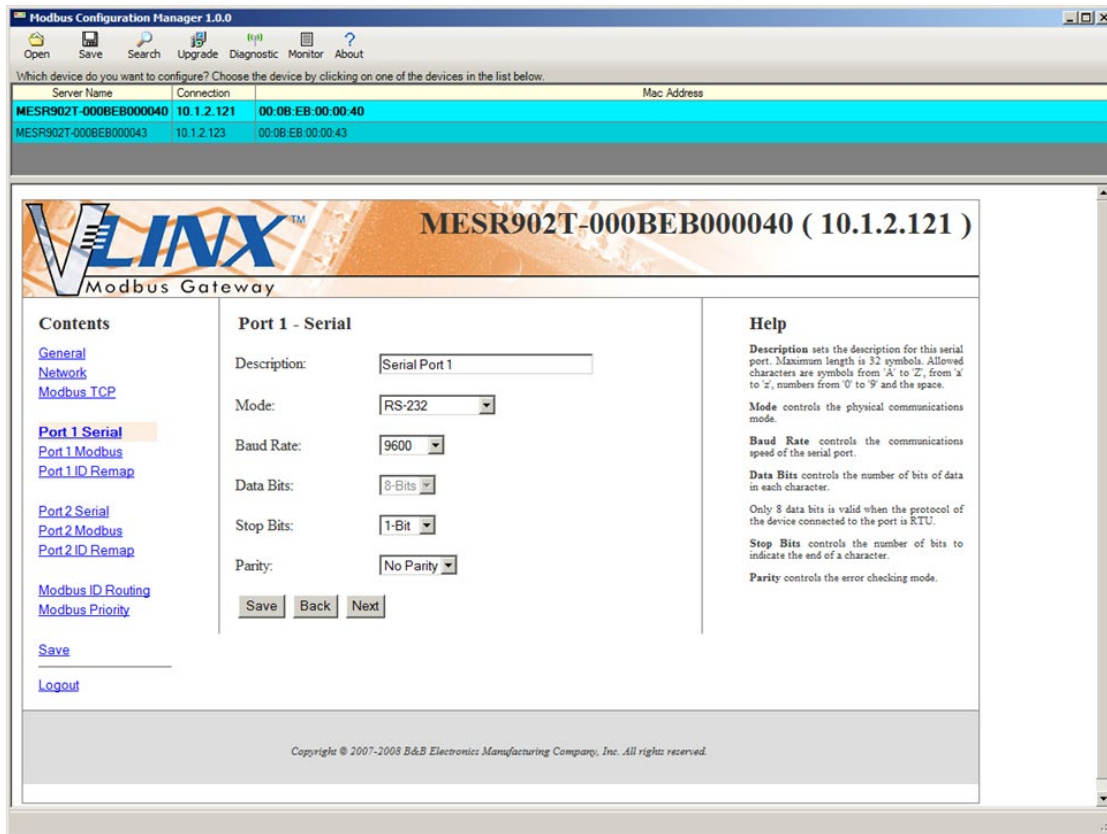

Figure 52. Serial Port 1 Setup

3. Configure Serial Port 1. In this case, it is RS-232, 19.2 kbps, 8 data bits, 1 stop bit, and even parity. Save the settings
4. Access Port 1 Modbus by clicking the link on the left side of the screen.

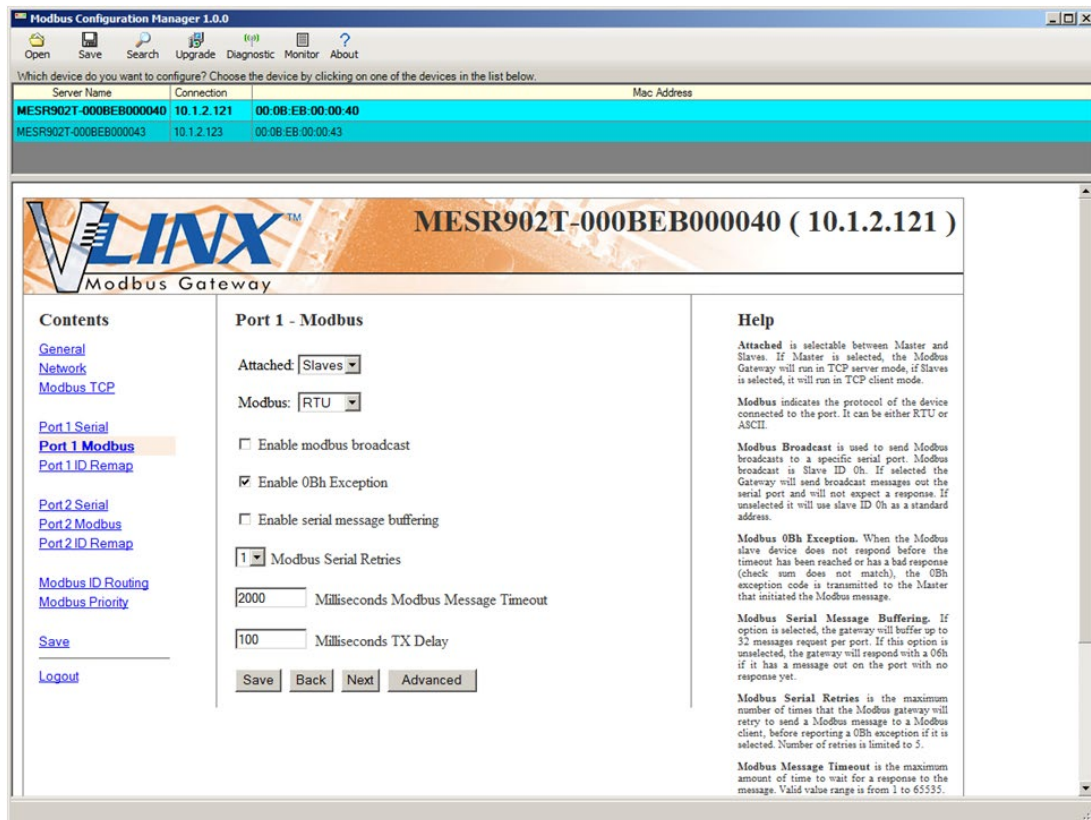

Figure 53. Port 1 Modbus

5. Configure the Port 1 Modbus settings. In this case, **Attached** should be slaves, **Modbus** should be RTU. The other settings depend on your application.
6. Configure Port 2 Serial and Modbus in the same way.
7. Access **Modbus ID Remapping** for each port and configure as necessary.

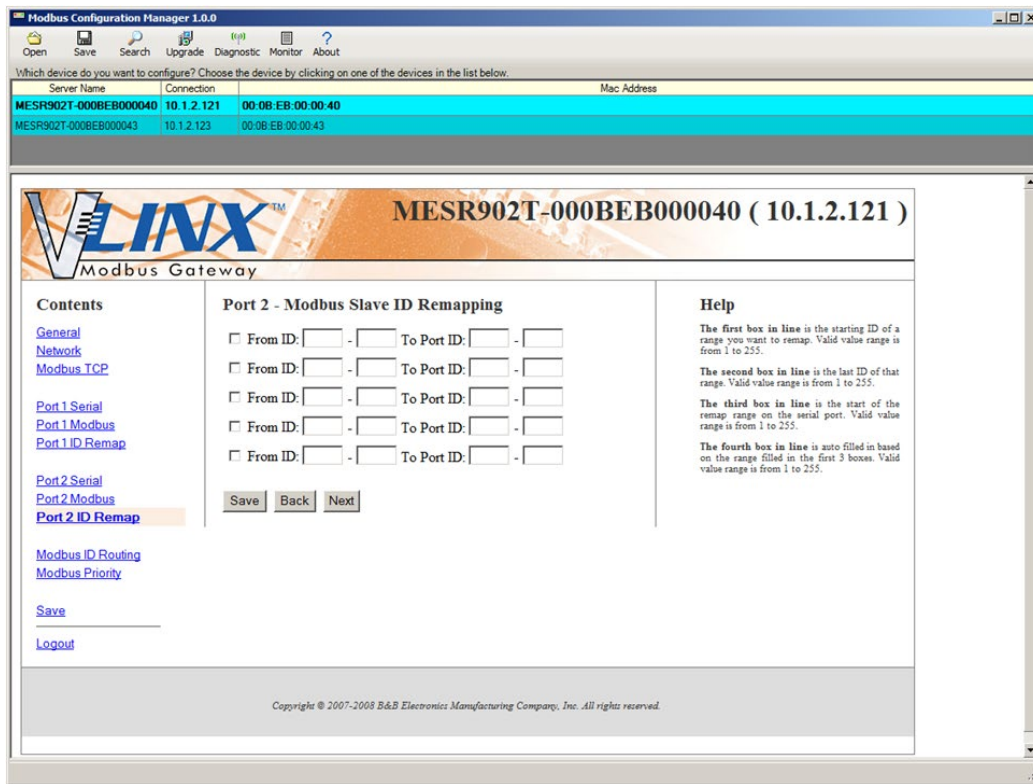

Figure 54. Port x Modbus Slave ID Remapping

8. Access **Modbus ID Routing**. Configure as necessary. In this example, Slave ID 200 is mapped to serial port 1, Slave ID 1 through 5 and 205 are mapped to serial port 2.

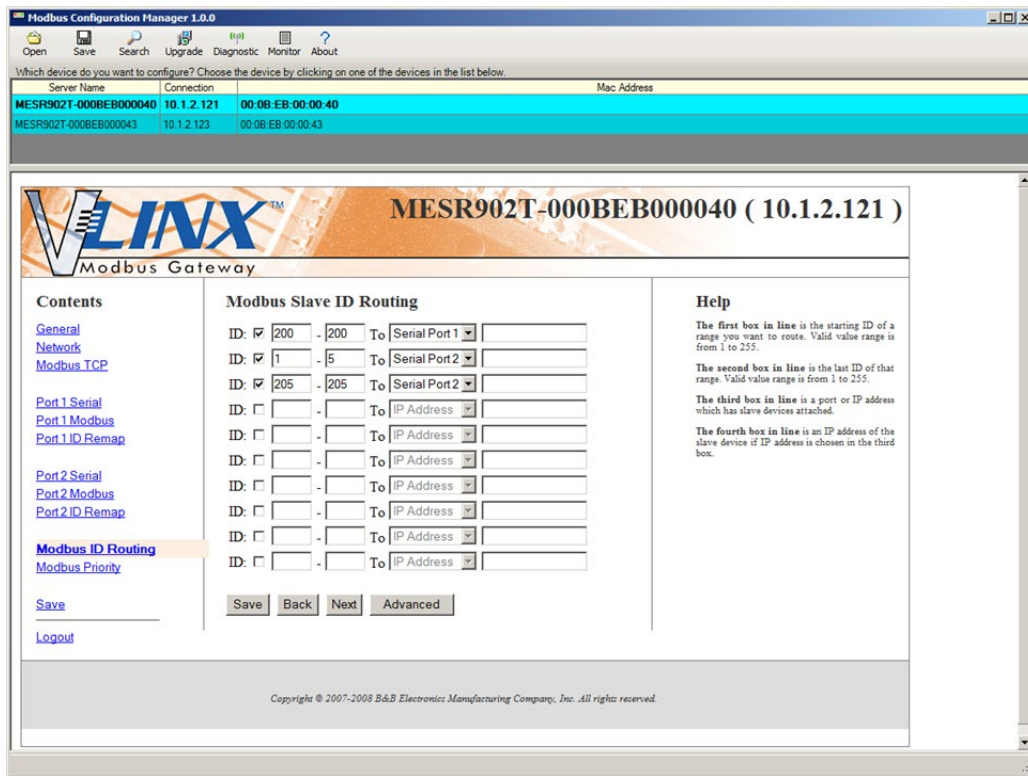

Figure 55. Modbus ID Routing

9. Access **Modbus Priority** and configure as necessary.

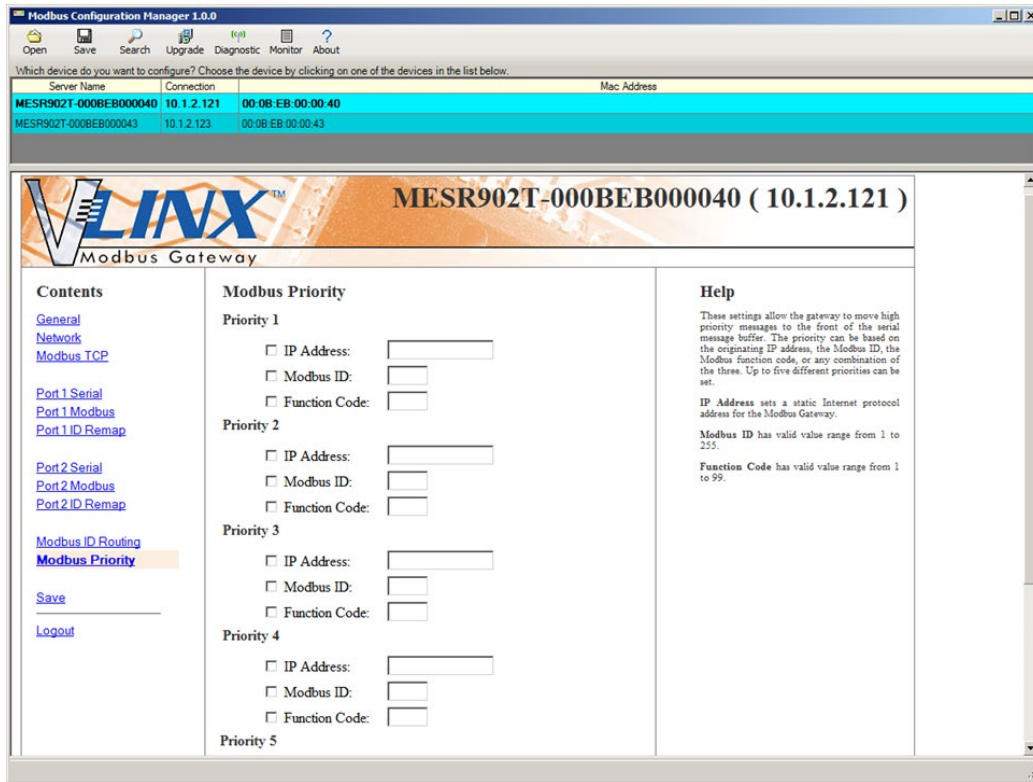

Figure 56. Modbus Priority

SERIAL & ETHERNET MASTERS, SERIAL & ETHERNET SLAVES

Your Modbus Gateway can also integrate multiple master devices onto serial and Ethernet networks.

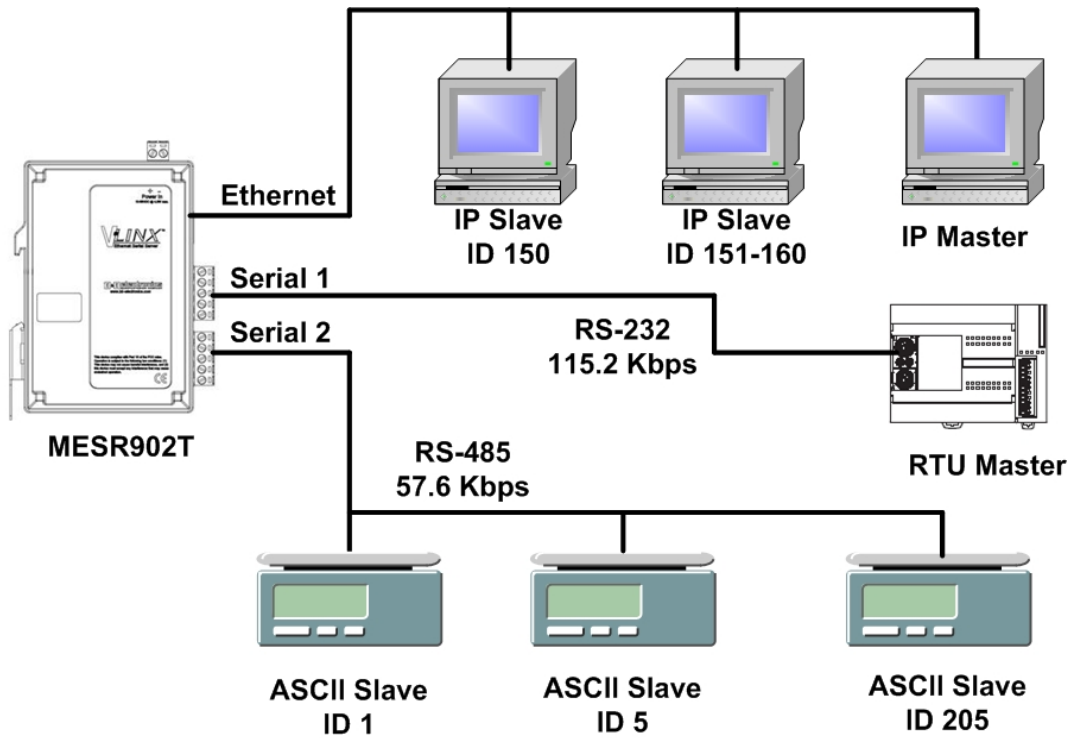

Figure 57. Serial & Ethernet Masters, Serial & Ethernet Slaves

1. In this example, Serial Port 1 has an RTU Master attached. Configure the serial port settings as appropriate for the device. Access the Port 1 Modbus screen and configure it the port for Modbus Master and RTU.

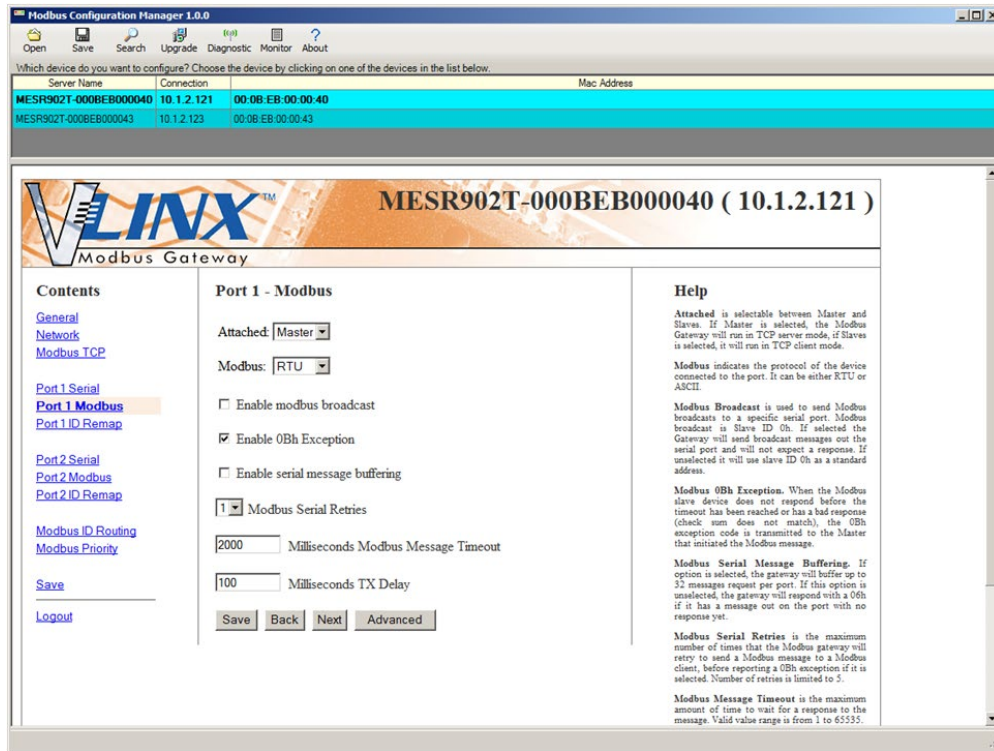

Figure 58. Port 1 Modbus

- Configure the Modbus Slave ID routing. In this case Modbus Slaves 1 through 5 and 205 are on Serial Port 2. Modbus Slaves 150 and 151 through 160 have IP assignments.

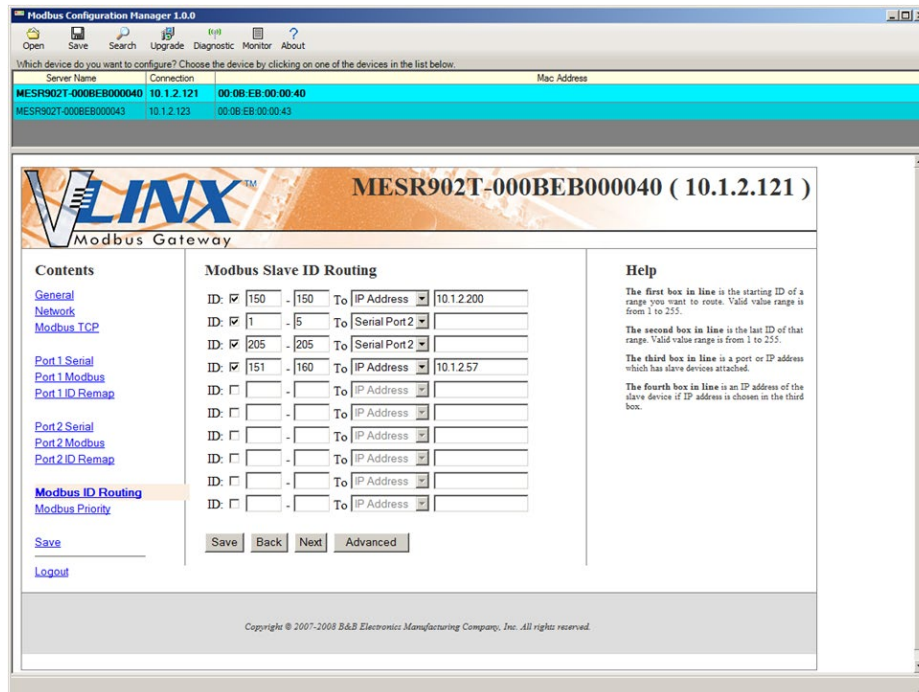

Figure 59. Modbus Slave ID Routing

SERIAL MASTERS, IP SLAVES

Serial Masters can be used to control IP slaves.

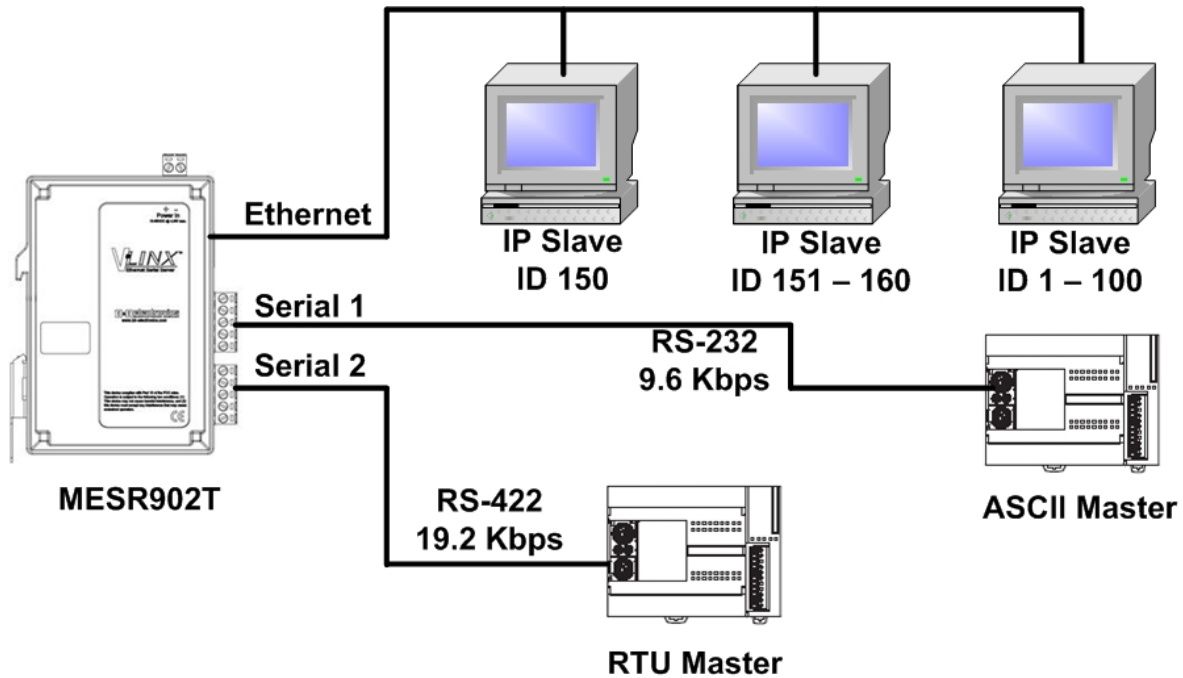

Figure 60. Serial Masters, IP Slaves

- 1) In this example, an ASCII Master is connected to Serial Port 1 and an RTU Master is connected to Serial Port 2. Configure the serial ports as appropriate for these devices.

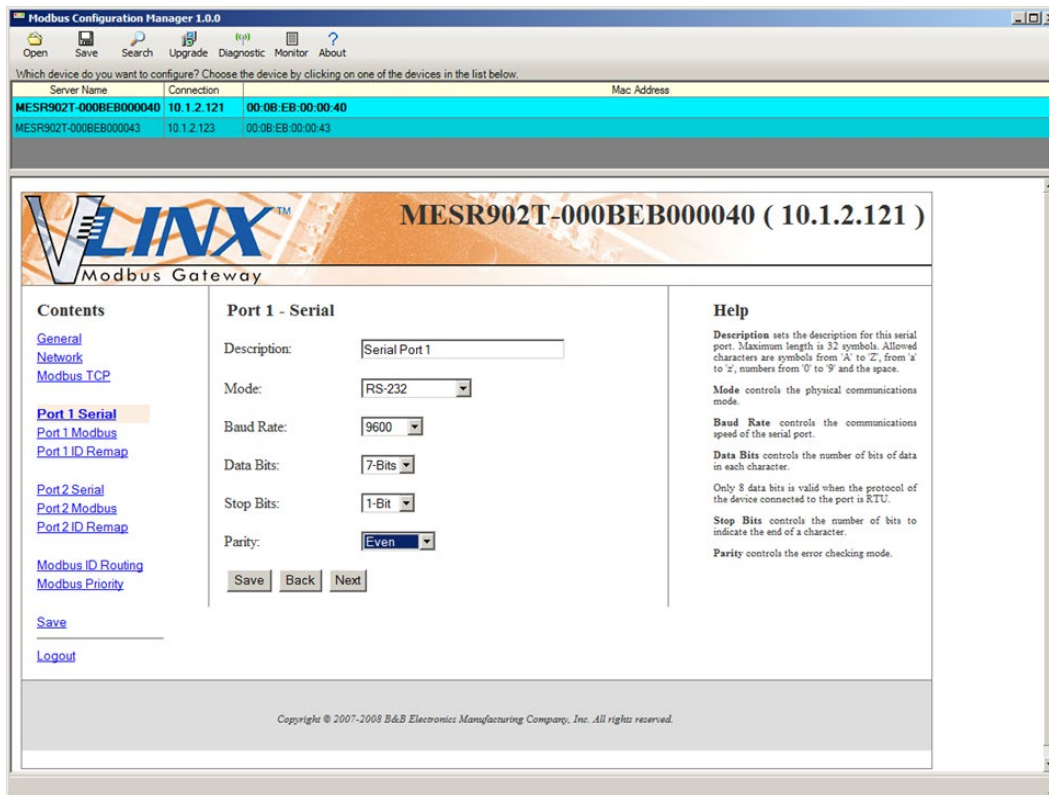

Figure 61. Port 1 Serial

2. Access the Modbus screen for each port and configure as appropriate. In this case, Port 1 has an ASCII Master and Port 2 has an RTU Master attached.

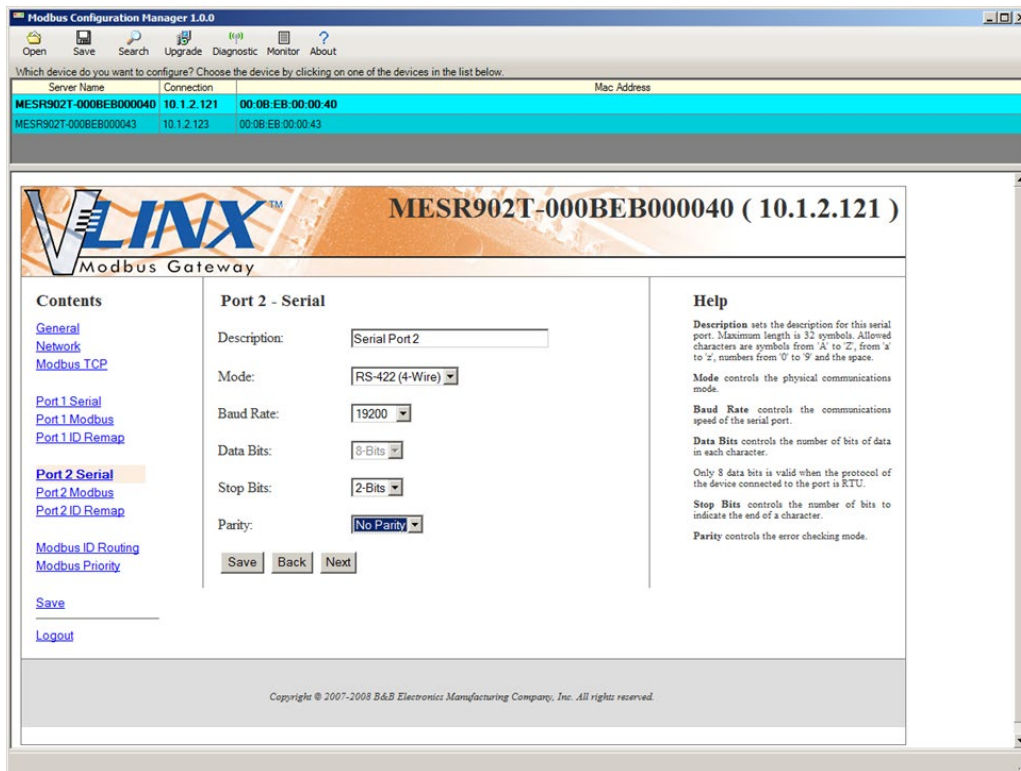

Figure 62. Port 2 Serial



Figure 63. Port 1 Modbus

- Set up the Slave ID Routing to associate IP addresses with the appropriate Slave ID.

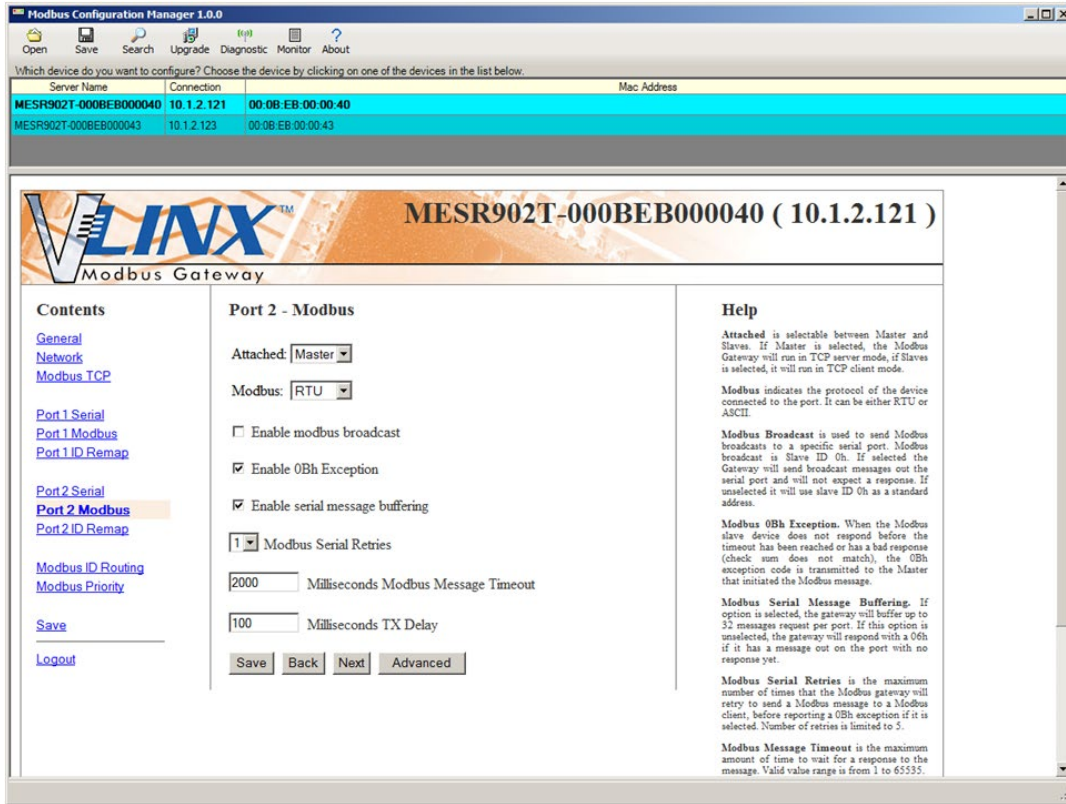

Figure 64. Port 2 Modbus

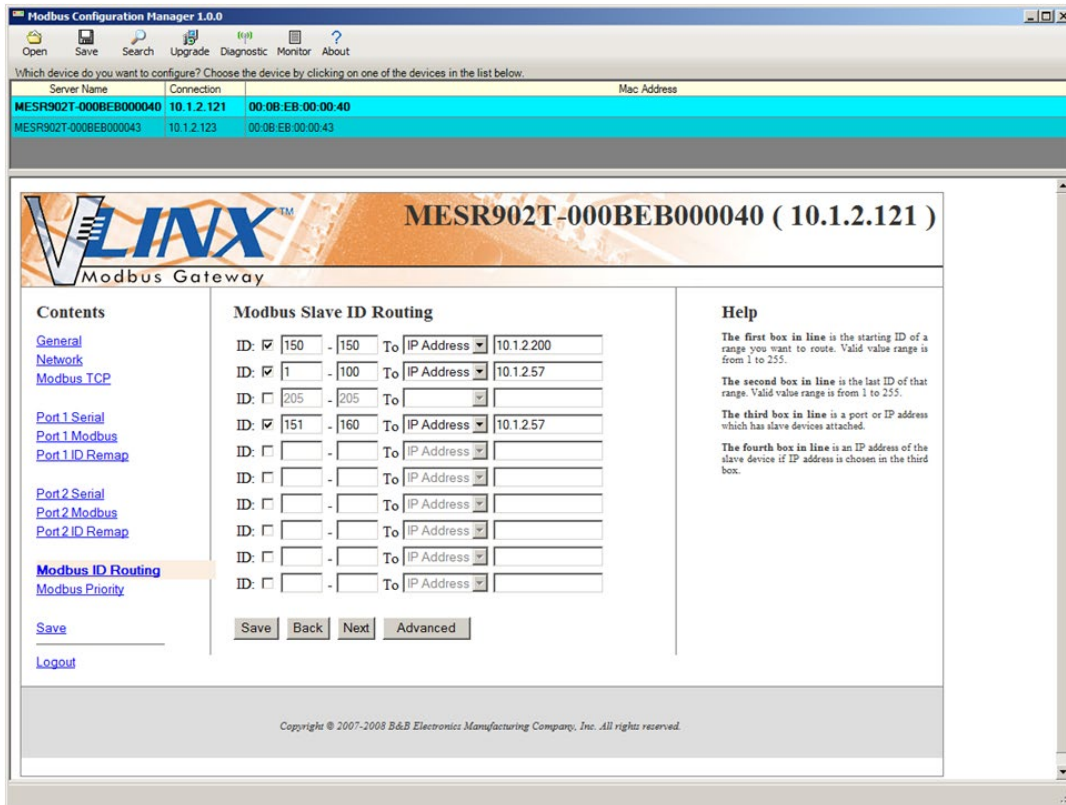

Figure 65. Modbus Slave ID Routing

IDENTICAL HARD CODED SLAVES

In this example, two slave devices that are hard coded with the same ID are required. This is accomplished by putting them on different serial ports.

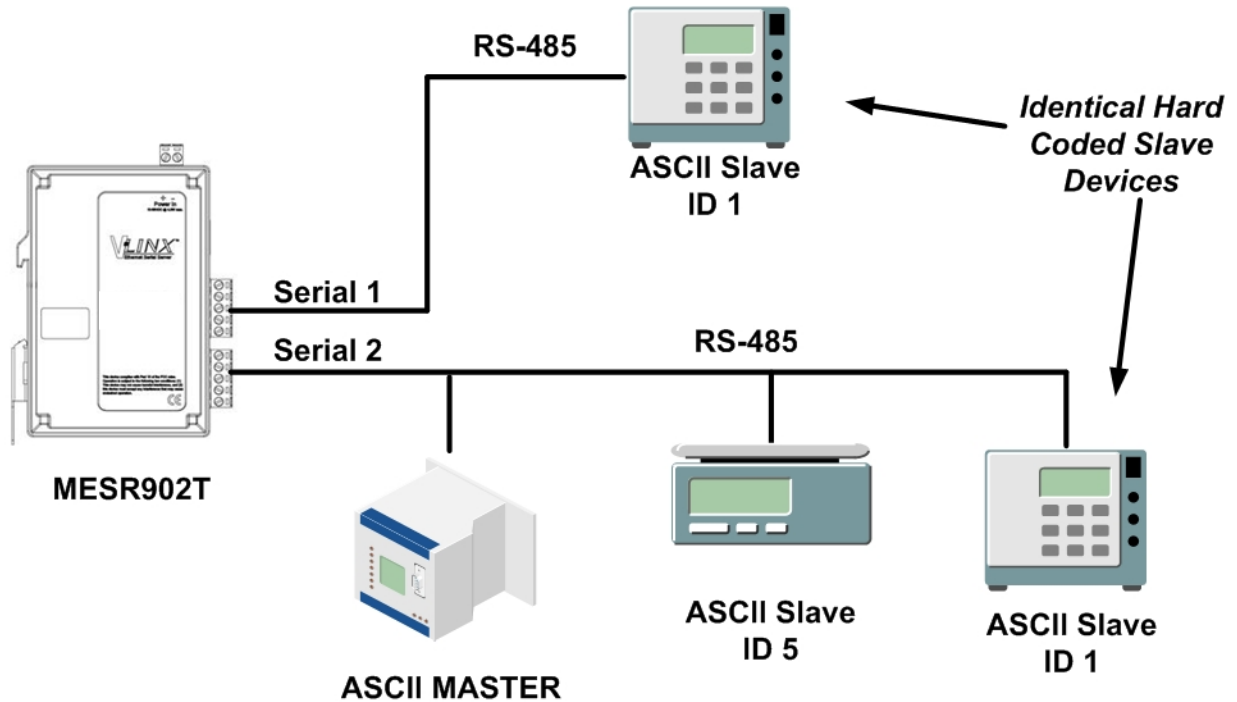

Figure 66. Identical Hard Coded Slaves

IDENTICAL PRODUCTION LINES

In this example, identical or backup production lines can be controlled by the same IP Master. This allows the duplicate networks to be configured identically, saving documentation and maintenance time.

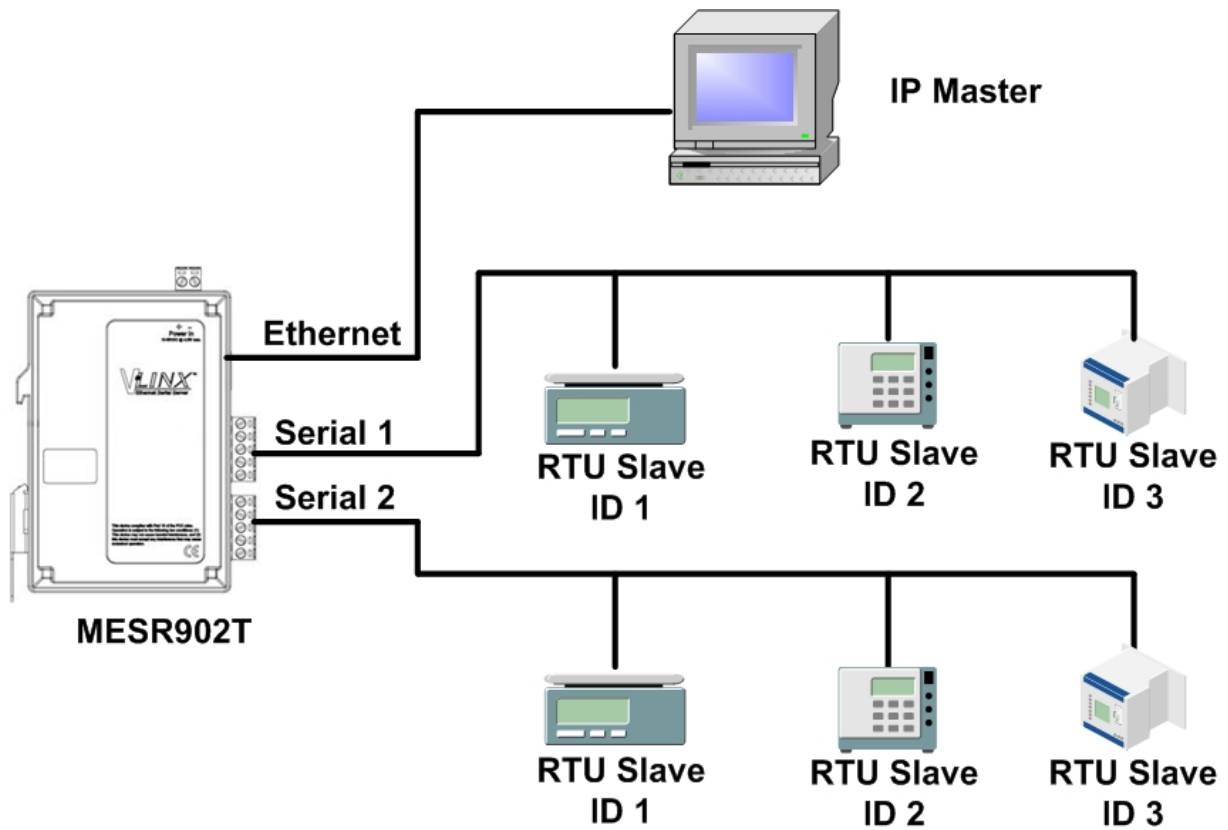

Figure 67. Identical Production Lines

7. MODBUS HELP

MODBUS ASCII / RTU BASICS

The Modbus protocol emerged in the mid-1970s as an early protocol for linking terminals with Modicon PLCs using a master/slave (sometimes called “master/client”-) relationship. As a simple, open, message-based protocol, it caught on quickly and became a de facto standard in the industry. It supports asynchronous point-to-point and multi-drop communications and can be used with a variety of serial interfaces (RS-232, RS-422, RS-485, modems, etc.).

The original Modbus specification included two possible transmission modes: ASCII and RTU. Modbus RTU mode is the most common implementation, using binary coding and CRC error-checking. Modbus ASCII messages, though somewhat more readable because they use ASCII characters, is less efficient and uses less effective LRC error checking. ASCII mode uses ASCII characters to start and end messages whereas RTU uses time gaps (3.5 character times) of silence for framing. The two modes are incompatible, so a device configured for ASCII mode cannot communicate with one using RTU.

All Modbus communications are initiated by Modbus masters using a polling query/response format. The master can send broadcast messages (using a slave address of 0), which all slaves accept, but do not reply to. More commonly, the master polls individual slaves sequentially. In each poll it sends a message containing a **device address**, followed by a **function code**, any **data** that maybe required, and an **error check** field. The addressed slave responds with a similar message structure. Typically, it repeats back its address and the function code, and then sends a field indicating the number of bytes of data that it is sending, followed by the data and the error check field.

Slave addresses can range from 1 to 247. Function codes include several common ones, typically used in all applications, and additional ones that may be implemented in specific cases. Common function codes include: Read Coil Status (01), Read Input Status (02), Read Holding Registers (03) and Read Input Registers (04).

When a master sends a message to a slave it expects to receive a valid response within certain length of time. If the slave does not receive the message, or if the slave receives the message but an error is detected, it does not respond. If the slave cannot respond appropriately for some other reason (e.g. it does not recognize the function code), it will return a message containing an exception response.

HINTS AND TIPS

A few simple suggestions that may assist you if your system is experiencing problems include:

- Slowing down the polling rate may be helpful if power cycling does not cure the problem.
- A common misperception is that every serial network must terminate with a resistor. While this was true of early serial network configurations, it is typically the wrong answer – call Advantech Technical Support to verify if your application is an exception.

A sometimes difficult problem is difference in grounding voltage between various network locations. Stray voltage from lightning or other sources may also find its way onto the network. These conditions make isolation necessary in many settings.

8. APPENDICES

This section includes the following Appendices:

- **Appendix A: Default Gateway Settings**
- **Appendix B: Product Specifications**
- **Appendix C: Dimensional Diagrams**
- **Appendix D: Connector Pinouts**

APPENDIX A: DEFAULT GATEWAY SETTINGS

Setting	Default Value
Gateway Name	User assigned
Password	Password field is blank from factory
DHCP	Enabled
IP Address	DHCP will configure. If a DHCP server is not available, the unit will default to 169.254.102.39
Net Mask	255.255.0.0
Gateway	169.254.102.100
MAC Address	Fixed - see bottom label
Firmware Version	(Vx.x.x)
Hardware Version	(Vx.x.x)
Port	1, 2
Serial Port Mode	RS-232
Baud Rate	9600
Data Bits	8
Parity	None
Stop Bits	1
Flow Control	None
Protocol	TCP
Serial Timeout	0 seconds
Inter-character Timer	0 ms
TCP Port	Port 1 = 4000 Port 2 = 4001
Maximum Connection	1

APPENDIX B: PRODUCT SPECIFICATIONS

This section includes the following specifications:

- General Specifications
- Controls, Indicators and Connector Specifications
- Serial Interface Specifications
- Network Specifications

GENERAL SPECIFICATIONS

Hardware and Included Accessories	Device	MESR901, MESR902T Modbus Gateway Module
	CD	CD with Vlinx™ Modbus Manager software for Windows 2000, XP (32/64 bit), 2003 Server (32/64 bit), Vista (32/64 bit), 2008 Server (32/64 bit), 7 (32/64 bit)
Optional Accessories	Cable	Null Modem Crossover Cable for DTE to DTE connection (Model# 232NM9)
Configuration Options	via serial port	Using Vlinx Modbus Manager via a serial connection, (press Reset button to enter Console Mode)
	via network	Using Vlinx Modbus Manager via a Ethernet connection
		Using a standard web browser such as Internet Explorer 6.0/7.0 or Firefox 1.5/2.0
Software	Vlinx Modbus Manager for Modbus Gateway Configuration	Windows 2000, XP (32/64 bit), 2003 Server (32/64 bit), Vista (32/64 bit), 2008 Server (32/64 bit), 7 (32/64 bit)
Environment	Operating Temperature	-40 to +80 °C (-40 to +176 °F)
	Storage Temperature	-40 to +85 °C (-40 to +185 °F)
	Operating Humidity	10 to 95% non-condensing
Certifications	FCC	Part 15 Class A
	CE	
	UL	UL Listed, File E222870 UL Class 1 Division 2 Groups A, B, C, D (HAZLOC), File E245458
	EU Directives	2014/30/EU - Electromagnetic Compatibility Directive (EMC) 2011/65/EU - Reduction of Hazardous Substances Directive (RoHS2) 2012/19/EU - Waste Electrical and Electronic Equipment (WEEE)
	EU Standards	EN 55032 Class B - Electromagnetic Compatibility of Multimedia Equipment - Emission Requirements EN 55024 - Information Technology Equipment - Immunity Characteristics - Limits and Methods of Measurement (ITE)
Enclosure	Rating	IP30
	Mounting	DIN rail mount (35 mm)
	Dimensions, medium case (MESR92x)	(2.8 x 11.4 x 15.7 cm (1.2 x 4.5 x 6.2 in))
	Dimensions, small case (MESR90x)	3.1 x 8.4 x 11.9 cm (1.2 in x 3.3 x 4.7 in)
Power Supply (external power supply required)	Voltage Requirements	10 to 48 VDC (58 VDC maximum)
	Power Consumption	MESR90x – 4.0W, maximum MESR92x – 6.0W, maximum
Terminal Blocks	Wire Size	28 to 16 AWG
	Wire Type	Copper Wire Only
	Tightening Torque	5 KG-cm
	Wire Temperature Rating	105°C, minimum, sized for 60°C ampacity
	Note	One conductor per terminal

CONTROLS, INDICATORS AND CONNECTOR SPECIFICATIONS

Switches	Reset Button	Hold in for 0 to 2 seconds for hardware reset. Hold in for 2 to 10 seconds for Console Mode (do a hardware reset or recycle power to exit Console Mode). Hold in for more than 10 seconds to reset to factory defaults.
Indicators	Serial LED (one per port)	Color = Green On = Port open Blink = Data traffic
	Link LED	Color = Green On = 100BaseTX Off = 10BaseT Blink = Data traffic
	Ready LED	Color = Green Blink (once per second) = System OK Off = System NOT OK
Connectors	10BaseT/100BaseTX Ethernet	Single RJ45F (8-pin)
	SC Fiber	SC connector
	ST Fiber	ST connector
	Serial	MESR901: (1) DB9M connector
		MESR902T: (2) pluggable, lockable, 5.08mm terminal blocks
DC Power	2-position pluggable, lockable, 5.08mm terminal block	

SERIAL INTERFACE SPECIFICATIONS

Mode Selection	RS-232/422/485, software selectable
RS-232 Lines	TXD, RXD, RTS, CTS, DTR, DSR, DCD, GND
RS-422 Lines	TXDA(-), TXDB(+), RXDA(-), RXDB(+), GND
RS-485 Lines (2-wire)	Data(-), Data(+), GND
RS-485 Lines (4-wire)	TXDA(-), TXDB(+), RXDA(-), RXDB(+), GND
Baud Rates	75, 150, 300, 600, 1200, 2400, 4800, 7200, 9600, 14400, 19200, 28800, 38400, 57600, 115200, 230400
Data Bits	5, 6, 7, 8
Parity	None, even, odd, mark, space
Stop Bits	1, 1.5, 2
Flow Control	None
RS-422/485 Biasing	Auto 4.7K Ohm pullups and pulldowns
RS-422/485 Termination	Auto-termination with through-hole resistor (user supplied)
RS-485 Data Control	Auto-control via MCU

NETWORK SPECIFICATIONS

Memory	Serial Memory	10 K bytes per port
	Network Memory	10 K bytes
I/P Port Addresses	5300	Configuration setting in TCP Mode
	8888	MESR9xx update
Network Communications	LAN	10/100 Mbps auto-detecting 10BaseT or 100BaseTX
Network Physical Layer Standards	Ethernet	IEEE 802.3 auto-detecting & auto MDI/MDX 10BaseT and 100BaseTX
Protocols Supported		TCP, IPv4, ARP, HTTP 1.0, ICMP/PING, DHCP/BOOTP
	IP Mode	Static, DHCP or Auto IP
	TCP	User definable
Connection Modes		Server, Client
Search		Serial direct COM and Ethernet auto-search or specific IP
Firmware Upgrade		Via serial, Ethernet or auto web search
Character Count		0 to 65535
Timeouts	Character	0 to 65535 ms, default set at 10 ms
	Modbus Message	0 to 65535 ms, default set at 1000 ms
	Serial	0 to 65535 sec

APPENDIX C: DIMENSIONAL DIAGRAMS

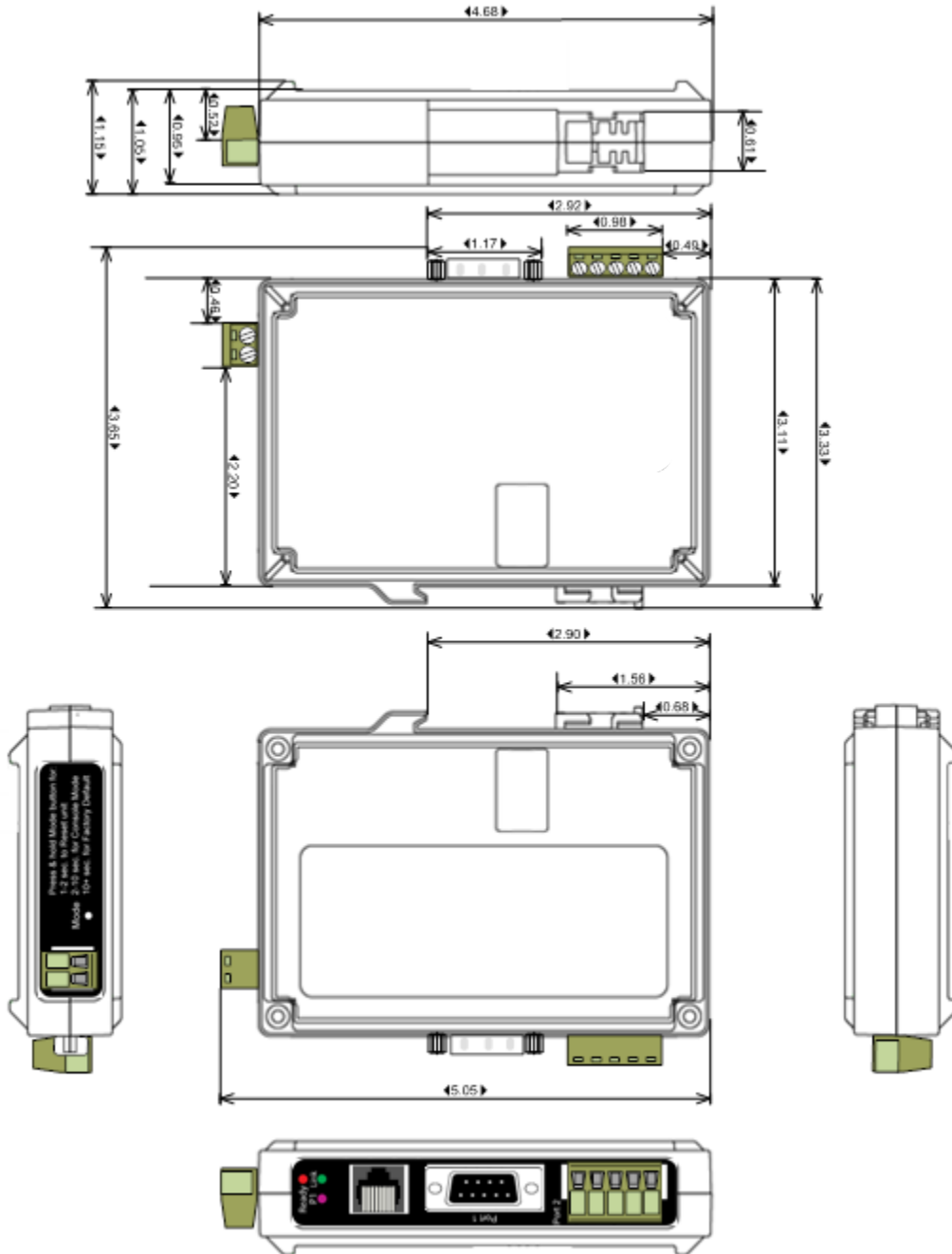

Figure 68. Dimensional Diagram of MESR901 Modbus Gateway (NOTE: small case used for MESR901 series units)

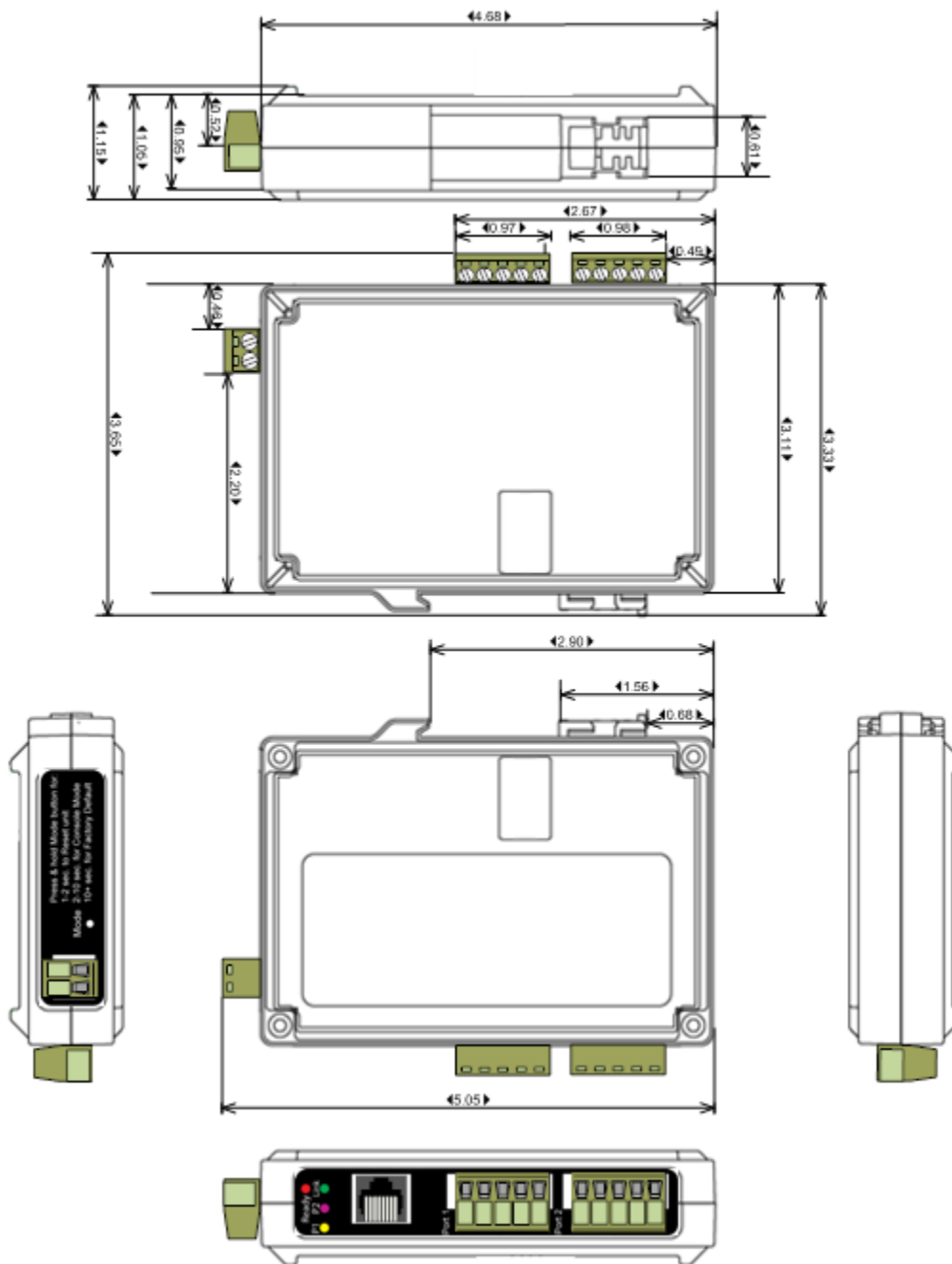

Figure 69. Dimensional Diagram of MESR902T Modbus Gateway (NOTE: small case used for MESR902 series units)

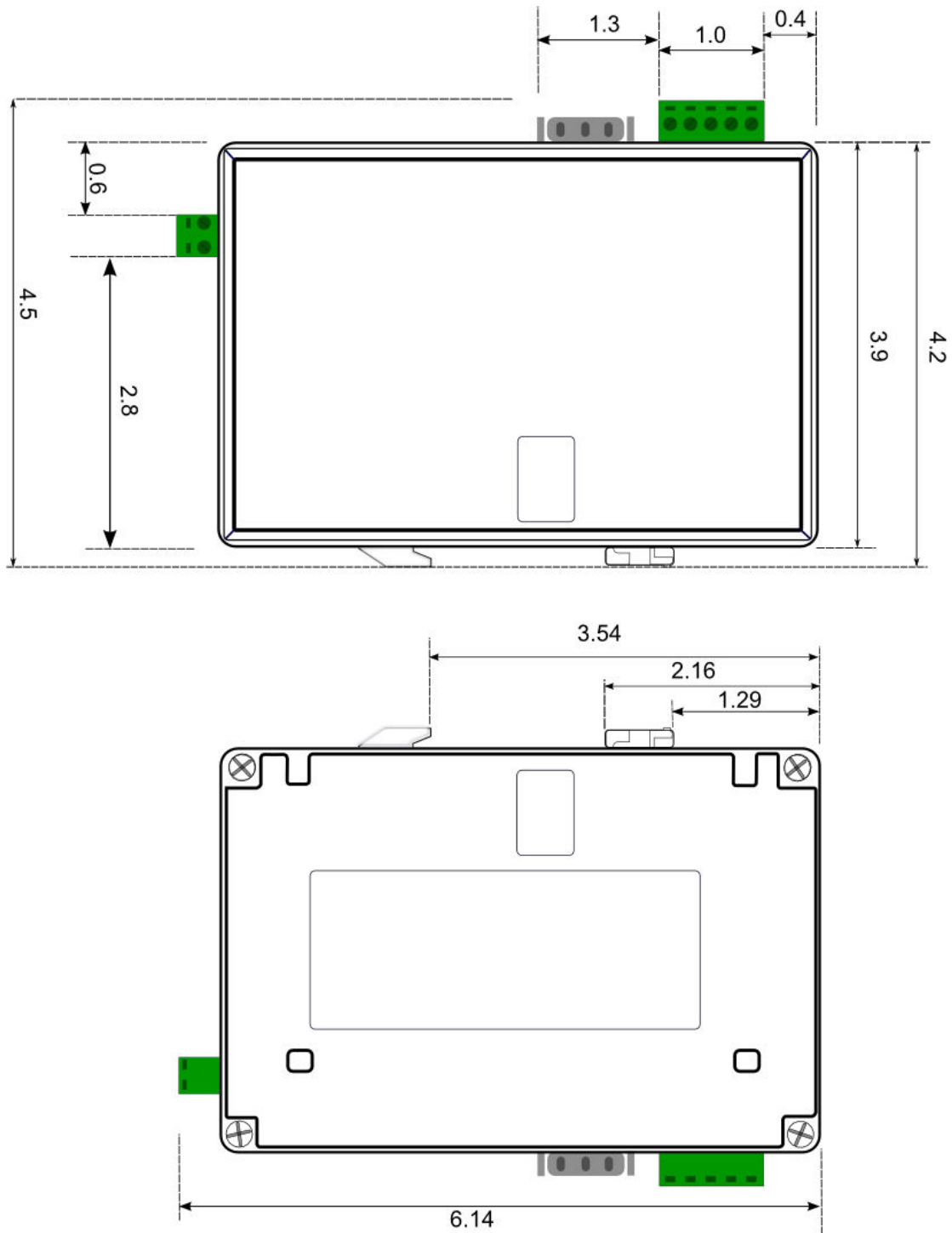

Figure 70. Dimensional Diagram of MESR921x Modbus Gateway (NOTE: medium case used for MESR921x series and MESR922Tx series units)

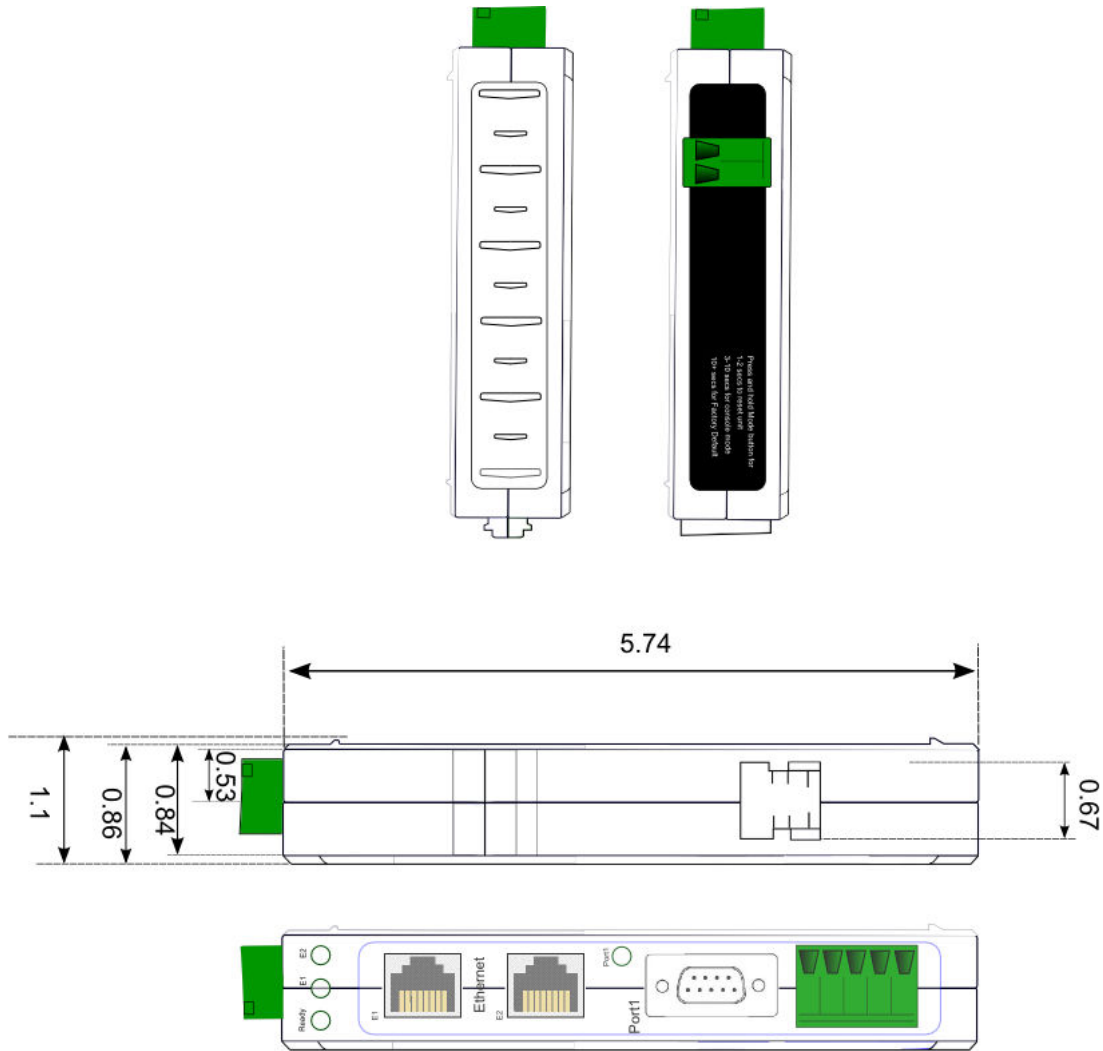
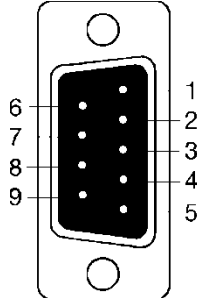

Figure 1. Dimensional Diagram of MESR921 Modbus Gateway, Bottom, Top, Back and Front Views (NOTE: medium case used for MESR921 series and MESR922 series units)

APPENDIX D: CONNECTOR PINOUTS

MESR901 SERIAL PORT PINOUTS



DB9 Male Pin	Direction	RS-232
1	Input	DCD
2	Input	RXD
3	Output	TXD
4	Output	DTR
5	---	GND
6	Input	DSR
7	Output	RTS
8	Input	CTS
9	Input	RI

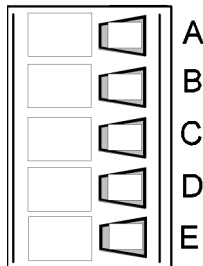

Terminal	RS-422/485 4-Wire	RS-485 2-Wire
A	TDA (-)	Data A (-)
B	TDB (+)	Data B (+)
C	RDA (-)	---
D	RDB (+)	---
E	GND	GND

MESR902T SERIAL PORT PINOUTS

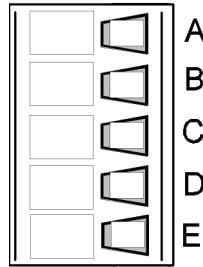

Terminal	RS-232	Direction (RS-232)	RS-422	RS-485
A	RTS	Output	TDA (-)	Data A (-)
B	TD	Output	TDB (+)	Data B (+)
C	CTS	Input	RDA (-)	---
D	RD	Input	RDB (+)	---
E	GND	---	GND	GND

In RS-422 mode, TX lines are outputs and RX lines are inputs. Connect the Modbus gateway TXB(+) line to the RXB(+) line of the Modbus network; and the Modbus gateway TXA(-) to the RXA(-) of the Modbus network.

Ground is Signal Ground and provides a common-mode reference for the RS-422 Receiver and Transmitters.

STANDARD ETHERNET CABLE RJ45 PIN-OUT

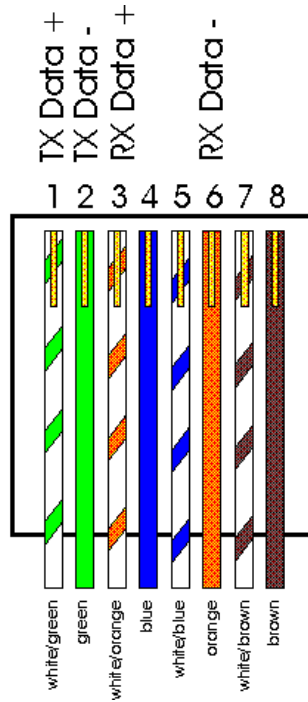

RJ45 Pin	Signal	Wire Color
1	TX+	White-Green
2	TX+	Green
3	RX+	White-Orange
4	Not used	Blue
5	Not used	White-Blue
6	RX-	Orange
7	Not used	White-Brown
8	Not used	Brown

GLOSSARY

Term	Definition
ADU	Application Data Unit
ASCII	American Standard Code for Information Interchange
Baud Rate	Number of bits per second
CRC	Cyclical Redundancy Checking
Data Bits	Number of bits per byte, normally 7 with Modbus ASCII, and 8 with Modbus RTU
DHCP	Dynamic Host Configuration Protocol
Flow Control	The process of managing the rate of data transmission between two nodes
Function Code	A code field that tells the Gateway what kind of action to perform
Modbus Gateway	A bridge to get from Modbus TCP to Modbus Serial
GUI	Graphical User Interface
IP	Internet Protocol
IPv4	Internet Protocol version 4
LED	Light Emitting Diode. Used as a visual indicator.
MBAP	Modbus Application Protocol
MEI	Multi-Electrical Interface via RS-232/422/485
Modbus	A request/reply protocol and offers services specified by function codes.
Parity Bit	A binary digit that is added to ensure that the number of bits with value of one in a given set of bits is always even or odd. It may also be a Mark (1), or a Space (0).
PDU	Protocol Data Unit
RS-232	Interface between Data Terminal Equipment and Data Circuit-Terminating Equipment Employing Serial Binary Data Interchange
RS-422	Electrical Characteristics of Generators and Receivers for Use in Balanced Digital Point to Point Systems
RS-485	Electrical Characteristics of Generators and Receivers for Use in Balanced Digital Multipoint Systems
RTU	Remote Terminal Unit
Stop Bit	Number of bit times after a character is transmitted before the next character can start transmission.
TCP	Transmission Control Protocol
Unit ID	Unit Identifier. This is the same as the slave/s' address.
MESRx	Advantech Modbus Ethernet Gateway Series
Vlinx	Advantech family name for the Ethernet gateway line

APPROVALS, DIRECTIVES, STANDARDS

Compliance	FCC, CE NEMA TS2 (Model MESR901)
UL	UL Listed, File E222870 UL Class 1 Division 2 Groups A, B, C, D (HAZLOC), File E245458

ADVANTECH TECHNICAL SUPPORT

Phone: 1 (800) 346-3119
Fax: (815) 433-5109
Email: support@advantech-bb.com
Web: www.advantech.com