

QUINT-PS/24DC/12DC/ 8

DC/DC converter with SFB technology, primary-switched, input: 24 V DC, output: 12 V DC, output current: 8 A



Data sheet
104792_en_01

© PHOENIX CONTACT 2013-05-02

1 Description

QUINT DC/DC converter – maximum system availability from SFB technology

Compact DC/DC converters from the new QUINT POWER generation maximize your system availability. With SFB technology (Selective Fuse Breaking Technology), 6-fold nominal current for 12 ms, it is possible to trigger even standard circuit breakers reliably and quickly. Faulty current paths are switched off selectively, the fault is located, and important system parts remain in operation. Comprehensive diagnostics are provided through constant monitoring of the input voltage, output voltage and output current. Preventive function monitoring visualizes critical operating states and indicates them to the controller before errors can occur.

The application fields for DC/DC converters are numerous

- Changing the voltage level
- Refreshing the output voltage for constant voltage at the end of long cables
- Setup of independent supply systems by electrical isolation

Features

- Wide-range voltage input
- Galvanic isolation
- Reverse polarity protection
- Preventive function monitoring
- Reliable starting of difficult loads with POWER BOOST static power reserve
- Fast tripping of standard circuit breakers with dynamic SFB technology power reserve
- High MTBF > 843,000 h (40°C)

Flexible use

- Adjustable output voltage
- Can be used in Class I, Division 2, Groups A, B, C, D (Hazardous Location) ANSI-ISA 12.12



Make sure you always use the latest documentation.
It can be downloaded from the product at phoenixcontact.net/products.

2 Table of contents

- 1 Description 1
- 2 Table of contents 2
- 3 Ordering data 3
- 4 Technical data 4
- 5 Safety regulations and installation notes 8
- 6 Basic circuit diagram 9
- 7 Structure 9
- 8 Installation 9
- 9 Dimensions and mounting positions 10
- 10 Mounting on DIN rails 11
 - 10.1 Normal mounting position 11
 - 10.2 Rotated mounting position (270° Y-axis) 11
- 11 Input 11
 - 11.1 Protection of the primary side 11
- 12 Output 12
 - 12.1 Protecting the secondary side 12
- 13 Output characteristic curve 12
- 14 SFB technology 13
 - 14.1 Circuit breaker tripping characteristics 13
 - 14.2 Installation notes 13
 - 14.3 Deactivating SFB technology 13
- 15 Signaling 14
 - 15.1 Active switching output “DC OK” 14
 - 15.2 Active switching output “I < IN” 14
 - 15.3 Active switching output “UIN > 19.2 V” 14
- 16 Derating 15
 - 16.1 Temperature-dependent derating 15
 - 16.2 Voltage-dependent derating 15
 - 16.3 Position-dependent derating 15
- 17 Other operating modes 16
 - 17.1 Series operation 16
 - 17.2 Parallel operation 16
 - 17.3 Redundant operation 16
 - 17.4 Increasing power 16

3 Ordering data

Description	Type	Order No.	Pcs. / Pkt.
QUINT DC/DC converter for DIN rail mounting, input: primary-switched, 24 V DC, output: 12 V DC/8 A, with integrated SFB (selective fuse breaking) technology, including mounted universal DIN rail adapter UTA 107/30	QUINT-PS/24DC/12DC/ 8	2320115	1
Accessories	Type	Order No.	Pcs. / Pkt.
QUINT power supply unit for DIN rail mounting, input: primary-switched, 1-phase, output: 24 V DC/10 A, with integrated SFB (selective fuse breaking) technology including mounted universal DIN rail adapter UTA 107	QUINT-PS/ 1AC/24DC/10	2866763	1
QUINT power supply unit for DIN rail mounting, input: primary-switched, 3-phase, output: 24 V DC/10 A, with integrated SFB (selective fuse breaking) technology including mounted universal DIN rail adapter UTA 107	QUINT-PS/ 3AC/24DC/10	2866705	1
Redundancy module with function monitoring, 12-24 V DC, 2x 10 A, 1x 20 A	TRIO-DIODE/12-24DC/2X10/1X20	2866514	1
Universal DIN rail adapter	UTA 107/30	2320089	25
Universal wall adapter	UWA 182/52	2938235	1
Assembly adapter for QUINT-PS... power supply on S7-300 rail	QUINT-PS-ADAPTERS7/1	2938196	1
Thermomagnetic device circuit breaker, 1-pos., tripping characteristic SFB, 1 PDT contact, plug for base element.	CB TM1 1A SFB P	2800836	1
Thermomagnetic device circuit breaker, 1-pos., tripping characteristic SFB, 1 PDT contact, plug for base element.	CB TM1 2A SFB P	2800837	1
Thermomagnetic device circuit breaker, 1-pos., tripping characteristic SFB, 1 PDT contact, plug for base element.	CB TM1 3A SFB P	2800838	1
Thermomagnetic device circuit breaker, 1-pos., tripping characteristic SFB, 1 PDT contact, plug for base element.	CB TM1 4A SFB P	2800839	1
Thermomagnetic device circuit breaker, 1-pos., tripping characteristic SFB, 1 PDT contact, plug for base element.	CB TM1 12A SFB P	2800844	1
Thermomagnetic device circuit breaker, 1-pos., tripping characteristic SFB, 1 PDT contact, plug for base element.	CB TM1 16A SFB P	2800845	1



Our range of accessories is being continually extended, our current range can be found in the download area.

4 Technical data

Input data	
Nominal input voltage	24 V DC
Nominal input voltage range	18 V DC ... 32 V DC 14 V DC ... 18 V DC (Consider derating during operation)
Current consumption	6 A
Inrush current limitation	< 15 A (typical)
I^2t	< 0.5 A ² s
Power failure bypass	> 10 ms (24 V DC)
Protective circuit	Transient surge protection Varistor
Protection against polarity reversal	≤ 30 V DC
Input fuse, integrated	15 A (internal (device protection))
Output data	
Nominal output voltage	12 V DC ±1%
Setting range of the output voltage	5 V DC ... 18 V DC (> 12 V constant capacity)
Output current	8 A (-25 °C ... 60 °C) 10 A (with POWER BOOST, -25 °C ... 40 °C permanent, U _{OUT} = 12 V DC) 48 A (SFB technology, 12 ms)
Magnetic fuse tripping	B2 / B4 / C2
Current limitation	Approx. 15 A
Max. capacitive load	Unlimited
Control deviation	< 1 % (change in load, static 10% ... 90%) < 2 % (change in load, dynamic 10% ... 90%) < 0.1 % (change in input voltage ±10%)
Efficiency	> 90 %
Ascent time	< 2 ms (U _{OUT} (10% ... 90%))
Residual ripple	< 20 mV _{PP}
Peak switching voltages	< 10 mV _{PP} (20 MHz)
Connection in parallel	Yes, for redundancy and increased capacity
Connection in series	Yes
Protection against surge voltage on the output	Yes, limited to < 25 V DC
Resistance to reverse feed	25 V DC
Power consumption	
Maximum power dissipation NO-Load	2 W
Power loss nominal load max.	10.5 W
Status and diagnostic indicator DC OK active	
Active switching output	U _{OUT} > 0.9 x U _N : High signal
Voltage	12 V DC
Current	< 20 mA (short-circuit resistant)
Status display	"DC OK" LED green

Status and diagnostic indicator POWER BOOST, active

Active switching output	$I_{OUT} < I_N$: High signal
Voltage	12 V DC
Current	< 20 mA (short-circuit resistant)
Status display	"BOOST" LED yellow/ $I_{OUT} > I_N$: LED on

Status and diagnostic indicator U_{IN} OK, active

Active switching output	$U_{IN} > 19.2$ V: High signal
Voltage	12 V DC
Current	≤ 20 mA (short-circuit resistant)
Status display	LED " $U_{IN} < 19.2$ V" yellow/ $U_{IN} < 19.2$ V DC: LED on

General data

Insulation voltage input/output	1.5 kV (type test) 1 kV (routine test)
MTBF	> 843000 h (According to EN 29500)
Normal mounting position	horizontal DIN rail NS 35, EN 60715
Dimensions W/H/D (normal mounting position/delivered condition)	32 mm / 130 mm / 125 mm
Dimensions W / H / D (X-axis rotated 270°)	122 mm / 130 mm / 35 mm
Weight	0.7 kg

Housing

Degree of protection	IP20
Type of housing	Aluminum (AlMg3)
Hood version	Galvanized sheet steel, free from chrome (VI)

Input connection data

Connection method	Pluggable screw connection
Conductor cross section, solid	0.2 mm ² ... 2.5 mm ²
Conductor cross section, stranded	0.2 mm ² ... 2.5 mm ²
Conductor cross section AWG/kcmil	24 ... 12
Stripping length	8 mm
Screw thread	M3
Tightening torque	0.5 Nm ... 0.6 Nm

Connection data, output/signals

Connection method	Pluggable screw connection
Conductor cross section, solid	0.2 mm ² ... 2.5 mm ²
Conductor cross section, stranded	0.2 mm ² ... 2.5 mm ²
Conductor cross section AWG/kcmil	24 ... 12
Stripping length	7 mm
Screw thread	M3
Tightening torque	0.5 Nm ... 0.6 Nm

Ambient conditions

Protection class	III
Ambient temperature (operation)	-25 °C ... 70 °C (> 60 °C derating)
Ambient temperature (start-up type tested)	-40 °C
Ambient temperature (storage/transport)	-40 °C ... 85 °C
Max. permissible relative humidity (operation)	≤ 95 % (at 25 °C, no condensation)
Vibration (operation)	< 15 Hz, amplitude ±2.5 mm (according to IEC 60068-2-6) 15 Hz ... 150 Hz, 2.3g, 90 min.
Shock	30 g in each direction, according to IEC 60068-2-27
Pollution degree in acc. with EN 50178	2
Climatic class	3K3 (in acc. with EN 60721)

Standards

Electrical Equipment for Machinery	EN 60204
Electrical safety (of information technology equipment - Safety - Part 1)	EN 60950-1/VDE 0805 (SELV)
Electronic equipment for use in electrical power installations	EN 50178/VDE 0160 (PELV)
SELV	EN 60950-1 (SELV) EN 60204 (PELV)
Safe isolation / protection against electric shock	DIN VDE 0100-410

Approvals

UL approvals	UL/C-UL listed UL 508 UL/C-UL Recognized UL 60950 UL ANSI/ISA-12.12.01 Class I, Division 2, Groups A, B, C, D (Hazardous Location)
Shipbuilding	Germanischer Lloyd (EMC 1)

Conformance with EMC Directive 2004/108/EC

Noise immunity according to EN 61000-6-2

	EN 61000-6-2 requirement	Tested
Electrostatic discharge EN 61000-4-2		
Housing contact discharge	4 kV (Test intensity 2)	8 kV (Test intensity 4)
Housing air discharge	8 kV (Test intensity 3)	15 kV (Test intensity 4)
Comments	Criterion B	Criterion A
Electromagnetic HF field EN 61000-4-3		
Frequency range	80 MHz ... 1 GHz	80 MHz ... 1 GHz
Test field strength	10 V/m	10 V/m
Frequency range	1.4 GHz ... 2 GHz	1 GHz ... 2 GHz
Test field strength	3 V/m	10 V/m
Frequency range	2 GHz ... 2.7 GHz	2 GHz ... 3 GHz
Test field strength	1 V/m	10 V/m
Comments	Criterion A	Criterion A
Fast transients (burst) EN 61000-4-4		
Input	2 kV (Test intensity 3 - asymmetrical)	2 kV (Test intensity 3 - asymmetrical)
Output	2 kV (Test intensity 3 - asymmetrical)	2 kV (Test intensity 3 - asymmetrical)
Signal	1 kV (Test intensity 3 - asymmetrical)	2 kV (Test intensity 4 - asymmetrical)
Comments	Criterion B	Criterion A
Surge current loads (surge) EN 61000-4-5		
Input	0.5 kV (Test intensity 1 - symmetrical) 0.5 kV (Test intensity 1 - asymmetrical)	1 kV (Test intensity 2 - symmetrical) 2 kV (Test intensity 3 - asymmetrical)
Output	0.5 kV (Test intensity 1 - symmetrical) 0.5 kV (Test intensity 1 - asymmetrical)	1 kV (Test intensity 2 - symmetrical) 2 kV (Test intensity 3 - asymmetrical)
Signal	1 kV (Test intensity 2 - asymmetrical)	1 kV (Test intensity 2 - asymmetrical)
Comments	Criterion B	Criterion A
Conducted interference EN 61000-4-6		
Input/Output/Signal	asymmetrical	asymmetrical
Frequency range	0.15 MHz ... 80 MHz	0.15 MHz ... 80 MHz
Voltage	10 V (Test intensity 3)	10 V (Test intensity 3)
Comments	Criterion A	Criterion A

Emitted interference in acc. with EN 61000-6-3

Radio interference voltage in acc. with EN 55011 EN 55011 (EN 55022) Class B, area of application: Industry and residential

Emitted radio interference in acc. with EN 55011 EN 55011 (EN 55022) Class B, area of application: Industry and residential



All technical specifications are nominal and refer to a room temperature of 25 °C and 70% relative humidity at 100 m above sea level.



Current approvals can be found for the product in the download area.

5 Safety regulations and installation notes



Before startup please ensure:

- Only qualified specialist personnel may install, start up, and operate the device.
- Observe the national safety and accident prevention regulations.



NOTE: Danger if used improperly

- The device is a built-in device.
- The IP20 degree of protection (IEC 60529/EN 60529) of the device is intended for use in a clean and dry environment. Do not subject the device to any load that exceeds the described limits.
- Do not subject the device to mechanical and/or thermal loads that exceed the specified limits.
- Installation and startup may only be carried out by qualified personnel. The relevant country-specific regulations must be observed.
- It is not permissible to open or modify the device. Do not repair the device yourself but replace it with an equivalent device. Repairs may only be carried out by the manufacturer. The manufacturer is not liable for damage resulting from violation.



CAUTION:

Before startup please ensure:

- Connection must be performed by specialist personnel and protection against electric shock ensured.
- It must be possible to switch off the device outside the power supply according to the regulations in EN 60950-1 (e.g., by line protection on the primary side).
- All feed lines are sufficiently protected and dimensioned!
- All output lines are dimensioned according to the maximum output current of the device or separately protected!
- Sufficient convection is guaranteed!



DANGER OF EXPLOSION!

Only remove equipment when it is disconnected and not in the potentially explosive area.

DANGER

Never carry out work on live parts!
The housing can become very hot, depending on the ambient temperature and load!

6 Basic circuit diagram

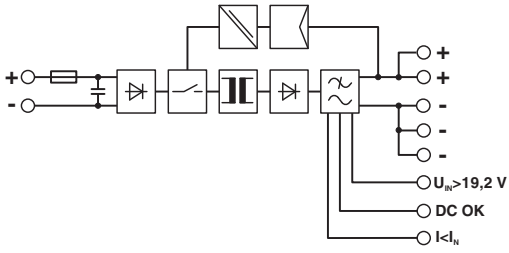

Figure 1 Block diagram

7 Structure

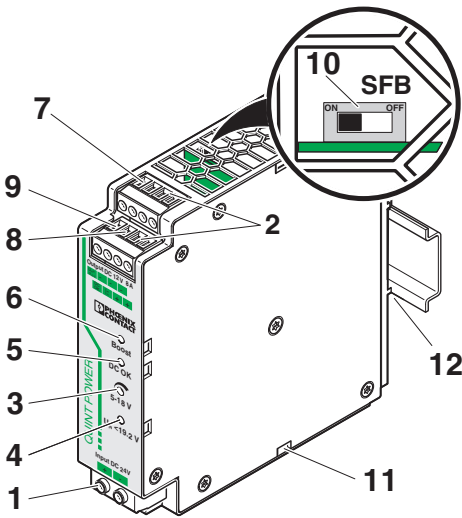

Figure 2 Function elements

- 1 DC input
- 2 DC output
- 3 Potentiometer 5 V DC ... 18 V DC
- 4 LED "U_{IN} < 19.2 V", yellow
- 5 "DC OK" LED, green
- 6 LED "BOOST", yellow
- 7 U_{IN} > 19.2 V, active switching output
- 8 I < I_N, active switching output
- 9 DC OK, active switching output
- 10 SFB switch (left: SFB activated, right: SFB deactivated)
- 11 Strain relief for connecting cables
- 12 DIN rail adapter

8 Installation

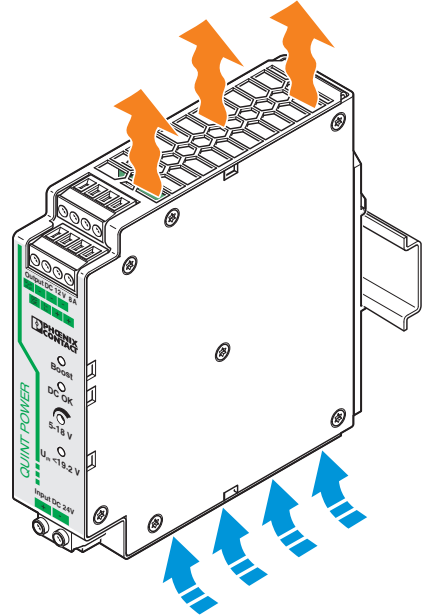

Figure 3 Convection



– To enable sufficient convection, we recommend a minimum vertical spacing of 50 mm from other devices. Lateral spacing of 5 mm, or 15 mm for active components, must be observed in order to ensure correct device function of the DC/DC converter.

– The housing can become very hot depending on the ambient temperature and load of the DC/DC converter.



The device can be snapped onto all DIN rails in accordance with EN 60715 and should be mounted in the normal mounting position (connection terminal blocks on top and bottom).

9 Dimensions and mounting positions

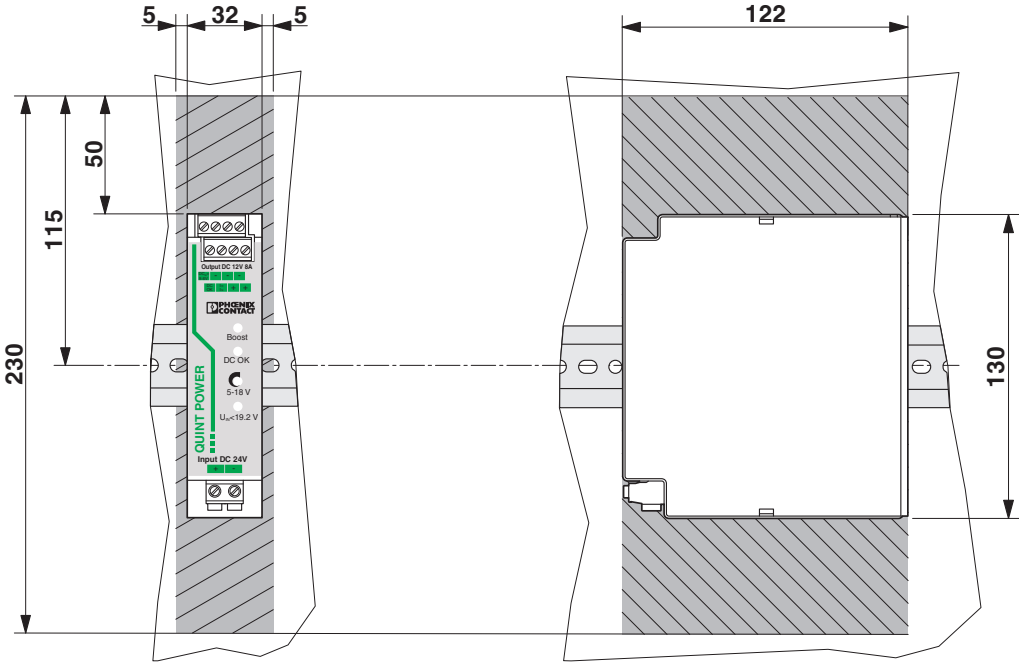

Figure 4 Dimensions

Possible mounting positions:

- Normal mounting position, installation depth 125 mm (+ DIN rail) (delivery state)
- Rotated mounting position, 270° Y-axis, installation depth: 35 mm (+ DIN rail)

10 Mounting on DIN rails

10.1 Normal mounting position

Assembly:

Position the DC/DC converter with the DIN rail guide on the top edge of the DIN rail and snap it in by pushing downward.

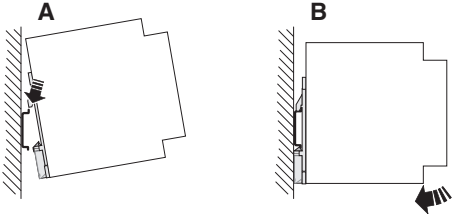

Removing:

Pull back the snap-on catch using a screwdriver and detach the DC/DC converter from the bottom edge of the DIN rail.

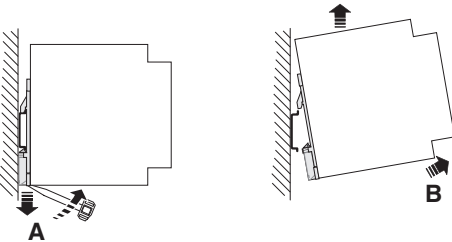

10.2 Rotated mounting position (270° Y-axis)

A rotated mounting position can be achieved for the DC/DC converter by mounting the device on the DIN rail at a 270° angle. Mount the DIN rail adapter (UTA 107/30) as shown in the figure. No additional mounting material is required. Mounting screws: Torx® T10 (0.8 Nm ... 0.9 Nm tightening torque).

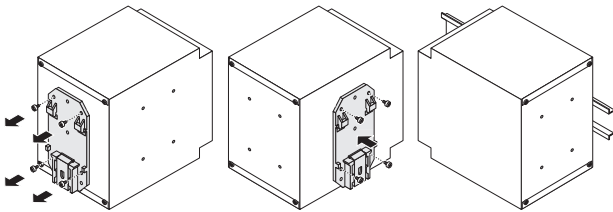

Figure 5 Rotated mounting position (270° Y-axis)



Other mounting positions are also possible. Always observe position-dependent derating.

11 Input

Connection to the input voltage is established via the screw connectors on the DC input screw connection.

The DC/DC converter converts a DC voltage of 18 ... 32 V into adjustable, regulated, and electrically isolated output voltage.

The DC/DC converter requires an input voltage of 18 V. During operation, this can drop down to 14 V, then observe derating.

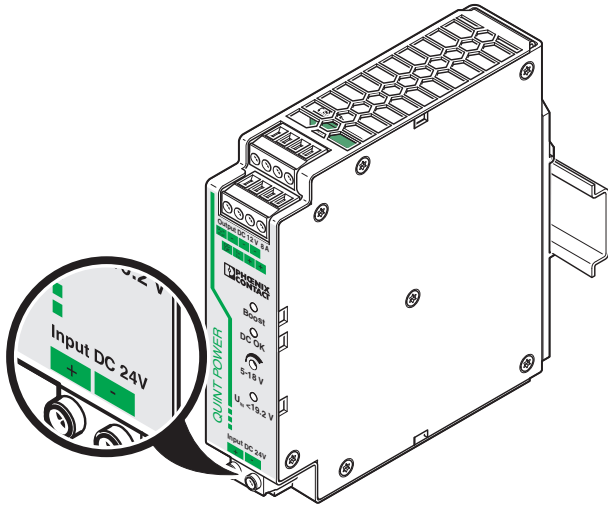

Figure 6 Input

11.1 Protection of the primary side

Installation of the DC/DC converter must correspond to EN 60950 regulations.

An internal fuse is provided for device protection. Additional device protection is not required.

The connecting cables on the primary side should have large cross sections to keep the voltage drops in the cables as low as possible.



NOTE: Module can become damaged
If an internal fuse is triggered, there is a device malfunction. In this case, the device must be inspected in the factory.

12 Output

Connection of the output voltage is established via the screw connectors on the DC output screw connection. The output voltage can be set on the potentiometer.

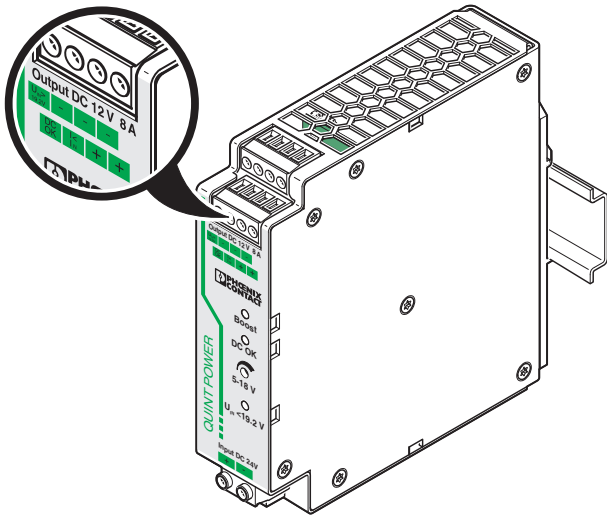

Figure 7 Output

12.1 Protecting the secondary side

The DC/DC converter is electronically short-circuit-proof and idling-proof. In the event of an error, the output voltage is limited. It must be ensured that all output cables are dimensioned accordingly for the maximum output current or have separate protection.

The connecting cables on the secondary side should have large cross sections to keep the voltage drops in the cables as low as possible.

13 Output characteristic curve

The DC/DC converter works with the POWER BOOST power reserve as shown in the U/I characteristic curve in the figure. At ambient temperatures < 40°C, I_{BOOST} is permanently available. It is also available at higher temperatures for a few minutes.

In the event of a secondary-side short circuit or overload, the output current is limited to I_{BOOST}. In this case, the DC/DC converter does not switch off but supplies output current continuously. The secondary voltage is then reduced until the short circuit is eliminated. The U/I characteristic curve with the POWER BOOST power reserve ensures that high inrush currents of capacitive loads in the primary circuit can be supplied reliably.

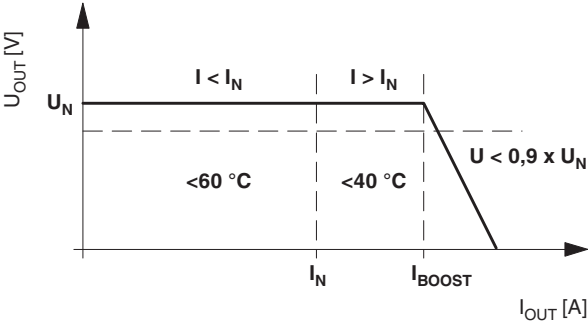

Figure 8 Output characteristic curve

- U_N = 12 V
- I_N = 8 A
- I_{BOOST} = 10 A
- SFB Technology = 48 A (for 12 ms)
- P_N = 96 W
- P_{BOOST} = 120 W

14 SFB technology

SFB (Selective Fuse Breaking) technology reliably switches off faulty current paths in the event of a short circuit. In this case, it supplies up to six times the nominal current for 12 ms. SFB technology therefore reliably triggers standard circuit breakers. Faults are located reliably and important system parts remain in operation.

14.1 Circuit breaker tripping characteristics

Typically, a circuit breaker trips within 3 ... 5 ms. Fast enough to avoid voltage drops of parallel connected loads.

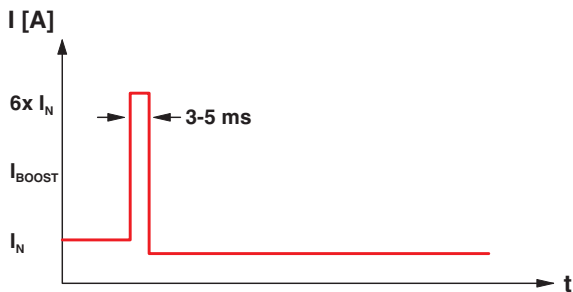

Figure 9 Quick tripping of circuit breakers with SFB technology

14.2 Installation notes

To use the SFB technology of the QUINT DC/DC converter, you must observe the following requirements:

- When designing the secondary side, consider the configuration matrix that describes the maximum cable lengths depending on the performance class of the devices, cable cross section, and the circuit breaker.



The current configuration matrix can be found in the product download area.

- Make sure that the source to be supplied is able to deliver a corresponding current pulse to supply the DC/DC converter. For example, this can be achieved by upstream connection of a QUINT SFB power supply (see accessories) or suitable battery capacity.
- Ensure the lowest possible cable impedance at the input of the DC/DC converter by using short cable lengths and large cable cross sections.



Observe the maximum distance between the source to be supplied and the DC/DC converter. (see also SFB configuration)



If conditions cannot be observed, SFB technology can be deactivated.

14.3 Deactivating SFB technology

The DC/DC converter is equipped with an additional SFB switch which can be used to deactivate SFB technology.

The SFB switch is located on the top side of the housing and is accessible for suitable tools, such as a small screwdriver through the vents.

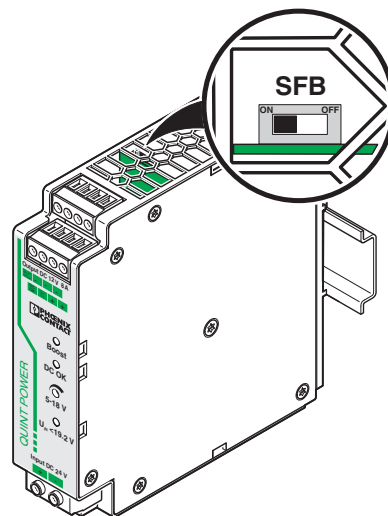

Figure 10 Position of the SFB switch

Switch position	SFB technology status
left	ON (default setting)
right	OFF



Activating/deactivating SFB technology must only be performed when the DC/DC converter is switched off.

15 Signaling

The active DC OK signal output, the active POWER BOOST signal output, and the active U_{IN} OK signal output are available for function monitoring. In addition, the DC OK LED, BOOST LED, and $U_{IN} < 19.2$ V LED enable function evaluation of the power supply directly at the installation location.

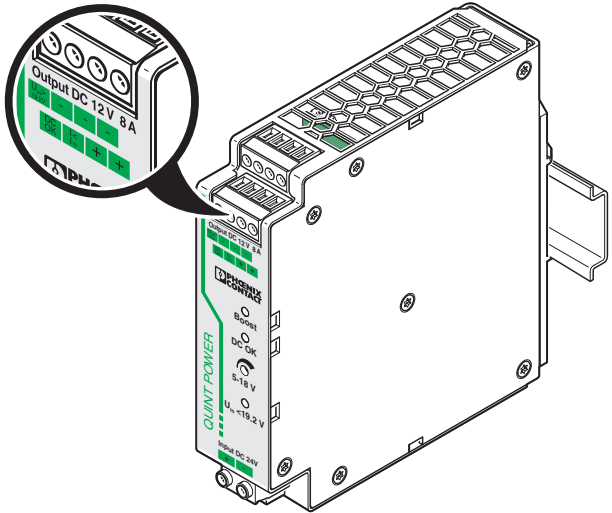

Figure 11 Signal outputs

Due to permanent monitoring of input voltage, output voltage and output current, critical operating states are reported before errors occur.

	$I < I_N$	$I > I_N$	$U < 0.9 \times U_N$
DC OK LED, green	Lit	Lit	Flashing
Boost LED, yellow	OFF	Lit	Lit
"DC OK" active switching output	high	high	low
" $I < I_N$ " active switching output	high	low	low
Meaning	Normal operation	Power Boost active	Overload

	$U_{IN} > 19.2$ V DC	$U_{IN} < 19.2$ V DC
" $U_{IN} < 19.2$ V" LED, yellow	OFF	Lit
Active switching output " $U_{IN} > 19.2$ V"	high	low
Meaning	U_{IN} OK	U_{IN} low

15.1 Active switching output "DC OK"

During normal operation of the DC/DC converter, the DC OK output signal ($U_{OUT} > 0.9 \times U_N$) is between connection terminal blocks "DC OK" and "-" and can carry a maximum of 20 mA. The DC OK signal output indicates an output voltage underrange of more than 10% by switching from "active high" to "low".

The DC OK signal is decoupled from the power output. This makes it impossible for devices connected in parallel to act as an external power supply.

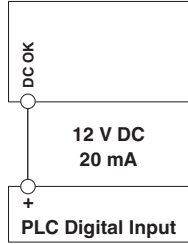

15.2 Active switching output " $I < I_N$ "

During normal operation of the DC/DC converter, the boost output signal ($I < I_N$) is between connection terminal blocks " $I < I_N$ " and "-" and can carry a maximum of 20 mA. The boost signal output indicates that the nominal current has been exceeded and that boost mode has been entered by switching from "active high" to "low".

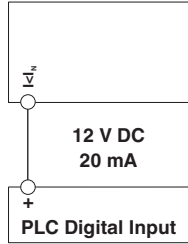

15.3 Active switching output " $U_{IN} > 19.2$ V"

During normal operation of the DC/DC converter, the $U_{IN} > 19.2$ V output signal is between connection terminal blocks " $U_{IN} > 19.2$ V" and "-" and can carry a maximum of 20 mA. The $U_{IN} > 19.2$ V signal output indicates a low input voltage by switching from "active high" to "low".

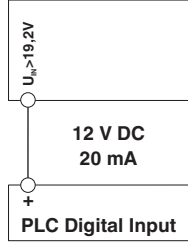

16 Derating

16.1 Temperature-dependent derating

With an ambient temperature of up to +40°C, the device supplies the continuous output current of I_{BOOST} . The device can supply a nominal output current of I_N with ambient temperatures of up to +60°C. In the case of ambient temperatures above +60°C, the output current must be reduced by 2.5% per Kelvin increase in temperature. The device does not switch off at ambient temperatures of +70°C or thermal overload. The output capacity is reduced as far as necessary to provide device protection. After it has cooled down, the output capacity is increased again.

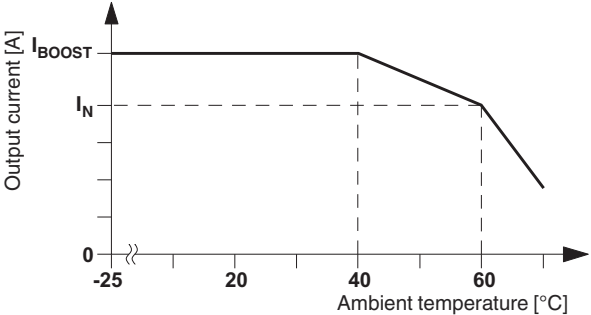

16.2 Voltage-dependent derating

The nominal input voltage of 24 V DC is divided into the areas of starting and operation. The DC/DC converter requires at least 18 V DC for cold starting, whereby the input voltage can sink to 14 V DC during operation. The device only switches off under this limit. The upper voltage limit is 32 V DC for both starting and operation.

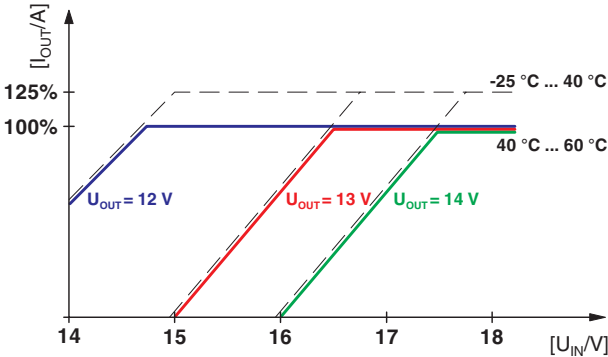

16.3 Position-dependent derating

The DC/DC converters can be snapped onto all DIN rails according to EN 50022-35. They should be mounted horizontally (input terminal blocks on bottom). When installing in a different mounting position, derating should be observed.

17 Other operating modes

17.1 Series operation

Two DC/DC converters can be connected in series to double the voltage. Only devices of the same performance class should be connected in series. Series connection should always be used if the output voltage of the module is not sufficient. For example, devices with 12 V DC nominal output voltage each supply 24 V DC in series. Depending on the specification of the PE connection, output voltages of +24 V or -24 V as well as ±12 V DC can also be made available.

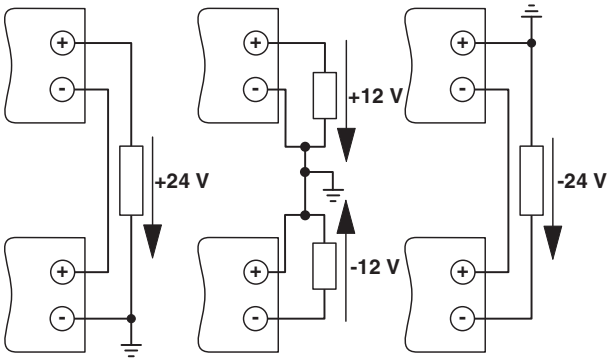
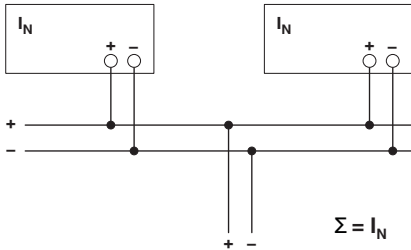

Figure 12 Series operation

17.2 Parallel operation

DC/DC converters of the same type can be connected in parallel to increase both redundancy and power. No further adjustments to the default setting are necessary. To ensure symmetrical load distribution, it is recommended that all cable connections from the DC/DC converters to the busbar are the same length and have the same conductor cross section.

Depending on the system, a protective circuit should be installed at each individual device output (e.g. decoupling diode or DC fuse) for parallel connection of more than two DC/DC converters. This prevents high return currents in the event of a secondary device fault.



17.3 Redundant operation

Redundant circuits are suitable for supplying systems, which place particularly high demands on operational safety. If a fault occurs in the primary circuit of the first power supply unit, the second device automatically takes over the complete power supply without interruption, and vice versa. For this purpose, the power supply units to be connected in parallel must be large enough to ensure that the total current requirements of all loads can be fully met by one power supply unit. External decoupling diodes are required for 100% redundancy!

Optimization of redundancy can be achieved by decoupling and monitoring. Phoenix Contact offers a comprehensive product range for this purpose (e.g., TRIO-DIODE or QUINT-DIODE).

Example: diode module

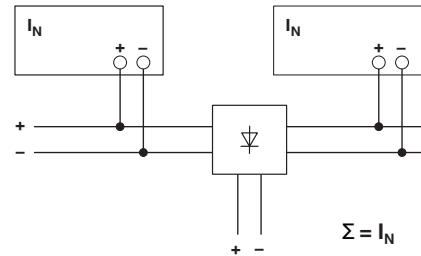

17.4 Increasing power

The output current can be increased to $n \times I_N$ in the case of n parallel connected DC/DC converters. Parallel connection for increasing power is used when extending existing systems. Parallel connection is recommended if the DC/DC converter does not cover the current consumption of the most powerful load. Otherwise, the loads should be distributed between individual devices that are independent of one another.

