

LTE Industrial Router

ICR-3211

USER MANUAL



ADVANTECH

Advantech B+B SmartWorx – Americas

Advantech B+B SmartWorx

707 Dayton Road
Ottawa, IL 61350 USA

Website

www.advantech-bb.com

Advantech B+B SmartWorx – Europe

Advantech B+B SmartWorx s.r.o.

Sokolska 71
562 04, Usti nad Orlici,
Czech Republic

Website

www.advantech-bb.com

© 2020 Advantech B+B SmartWorx s.r.o. No part of this publication may be reproduced or transmitted in any form or by any means, electronic or mechanical, including photography, recording, or any information storage and retrieval system without written consent. Information in this manual is subject to change without notice, and does not represent a commitment on the part of Advantech B+B SmartWorx.

Advantech B+B SmartWorx s.r.o. shall not be liable for incidental or consequential damages resulting from the furnishing, performance, or use of this manual.

All brand names used in this manual are the registered trademarks of their respective owners. The use of trademarks or other designations in this publication is for reference purposes only and does not constitute an endorsement by the trademark holder.

Used Symbols



Danger – Information regarding user safety or potential damage to the router.



Attention – Problems that can arise in specific situations.



Information, notice – Useful tips or information of special interest.

GPL Licence

Source codes under GPL licence are available free of charge by sending an email to:

techSupport@advantech-bb.com.

Please see <http://ep.advantech-bb.cz/devzone> for more information.



Contents

1	Safety Instructions	2
2	WEEE directive	3
3	Router Description	4
3.1	Usage of the Router	5
4	Contents of Package	8
5	Router Design	9
5.1	Router Versions	9
5.2	Device Labels	10
5.3	Order Codes	10
5.4	Basic Dimensions of the Router Box (specified in mm)	11
5.5	Mounting Recommendations	12
5.6	Removing from the DIN Rail	13
5.7	Description of the Front Panel	14
5.7.1	Status Indication	15
5.7.2	Power Connector PWR	16
5.7.3	Ethernet Port ETH0 and ETH1	17
5.7.4	Antenna Connector ANT	18
5.7.5	Reset Button	19
5.8	Description of the Left Panel	21
5.8.1	SIM Card Reader	22
5.8.2	Serial Interfaces and I/O Port	23
6	First Use	25
6.1	Connecting the Router Before First Use	25
6.2	Start	25
6.3	Configuration	25
6.3.1	Configuration by Web Browser	25
7	Technical Parameters	27
7.1	Basic Parameters	27
7.2	Standards and Regulations	28
7.3	Type Tests and Environmental Conditions	29
7.4	Technical Parameters of Cellular Module	30
7.5	Other Technical Parameters	31

8 Recommended Literature	32
9 Troubleshooting	33
9.1 FAQ	33
10 Customers Support	36
10.1 Customer Support for NAM	36
10.2 Customer Support for Europe	36
10.3 Customer Support for Asia	36

List of Figures

1	Access to the Internet from LAN	5
2	Backed up access to the Internet	6
3	Using VPN tunnel	6
4	Serial Gateway	7
5	OWL LPWAN	9
6	Labels example	10
7	Basic dimensions of the router box	11
8	Basic dimensions of the router box	11
9	Default position of DIN rail clip	13
10	Removing from the DIN rail	13
11	The front panel of the router	14
12	Power connector	16
13	Connection of power supply	16
14	Ethernet connector	17
15	Connection of Ethernet cables	17
16	Connecting the antenna	18
17	Router reset	19
18	The left panel of the router	21
19	SIM card reader	22
20	Serial + I/O connector	23
21	Functional scheme of the binary interface	24
22	Entering the IP address of the router	25
23	Entering login information	26
24	Router web interface	26

List of Tables

1	Contents of package	8
2	Router versions	9
3	Order Codes Overview	10
4	Description of the front panel	14
5	Status indication	15
6	Connection of power connector	16
7	Connection of Ethernet connector	17
8	Overview of router reboot and reset	20
9	Description of the left panel	21
10	Connection of RS485	23
11	Connection of I/O	23
12	Connection of RS232	23
13	Basic parameters	27
14	Standards and regulations	28
15	Type tests and environmental conditions	29
16	Technical parameters of cellular module	30
17	Other technical parameters	31

1. Safety Instructions



Please, observe the following instructions:

- The router must be used in compliance with all applicable international and national laws and in compliance with any special restrictions regulating the utilization of the router in prescribed applications and environments.
- To prevent possible injury and damage to appliances and to ensure compliance with all relevant provisions, use only the original accessories. Unauthorized modifications or the use of unapproved accessories may result in damage to the router and/or a breach of applicable regulations. Unauthorized modifications or use of unapproved accessories may void the warranty.
- The router can not be opened.
- Turn off the router and disconnect it from power supply before handling the SIM card.
- **Caution!** The SIM card could be swallowed by small children.
- Power supply must not exceed 36 V DC max.
- Do not expose the router to extreme ambient conditions. Protect the router against dust, moisture and high temperature.
- Only routers with appropriate certification and labelling should be used in locations where flammable and explosive materials are present, including gas stations, chemical plants, or locations in which explosives are used. We remind users of the duty to observe the restrictions concerning the utilization of radio devices at such places.
- Switch off the router when travelling by plane. Utilization of the router on a plane may endanger the operation of the plane or interfere with the mobile telephone network, and may be unlawful. Failure to observe these instructions may result in the suspension or cancellation of telephone services for the respective client and/or may result in legal sanctions.
- When using the router in close proximity to personal medical devices, such as cardiac pacemakers or hearing aids, you must proceed with heightened caution.
- The router may cause interference when used in close proximity to TV sets, radio receivers or personal computers.
- It is recommended that you create an appropriate copy or backup of all important settings that are stored in the memory of the device.
- The device should not be used in the location where the children are present.



2. Product Disposal Instructions

The WEEE (Waste Electrical and Electronic Equipment: 2012/19/EU) directive was introduced to ensure that electrical/electronic products are recycled using the best available recovery techniques in order to minimize impact on the environment. This product contains high quality materials and components which can be recycled. At the end of its life this product **MUST NOT** be mixed with other commercial waste for disposal. The device contains the battery. Remove the battery from the device before disposal. The battery in the device needs to be disposed apart accordingly. Check the terms and conditions of your supplier for disposal information.

3. Router Description

ICR-3211 is an industrial cellular router intended for the market in Europe, Middle East and Africa (EMEA) area as well as for the North American market (NAM). The ICR-3211 router is designed for wireless communication in the mobile networks that make use of traditional cellular technologies. The primary purpose of this router is its use in the Category M1 (Cat M1) services on the cellular LTE network.

LTE Cat M1 is a new cellular technology specifically designed for the needs of applications targeting the Internet of Things (IoT) or machine-to-machine (M2M) communications. LTE Cat M1 is a low-power wide-area (LPWA) air interface that lets you connect IoT and M2M devices with medium data rate requirements (375 kbps upload and download speeds in half duplex mode).

The standard configuration includes two Ethernet 10/100 ports, serial line RS232, RS485, one binary input and one output. The device also has two readers for 3 V and 1.8 V SIM cards, which are located on the left panel of the router. The router can be provided only in a metal casing.

The ICR-3211 router is equipped with a power backup feature. It is a short-term power backup (maximum 15 seconds - depending on technology) which is used to complete the running operation or to send the required data immediately after failure of power supply.

Configuration of the router may be done via a password-protected Web interface. Web interface provides detailed statistics about the router's activities, signal strength, detailed system log etc. The router supports the creation of VPN tunnels using IPSec, OpenVPN and L2TP to ensure safe communication. DHCP, NAT, NAT-T, DynDNS, NTP, VRRP, control by SMS, backup primary connection and many other functions are supported.

The router provides diagnostic functions which include automatically monitoring the PPP connection, automatic restart in case of connection losses, and a hardware watchdog that monitors the router status. The user may insert Linux scripts which are started on various actions. It is possible to create up to four different configurations for the same router. These configurations can be switched whenever necessary via Web interface, SMS or binary input status. The router can automatically upgrade its configuration and firmware from your central server. This allows for mass reconfiguration of numerous routers at the same time.

The router also supports additional software like R-SeeNet for permanent traffic monitoring of routers.



Examples of possible applications

- mobile office
- fleet management
- security system
- telematic
- telemetric
- remote monitoring
- vending and dispatcher machines

3.1 Usage of the Router

The router is primarily intended for these four basic situations:

I. Access to the Internet from LAN

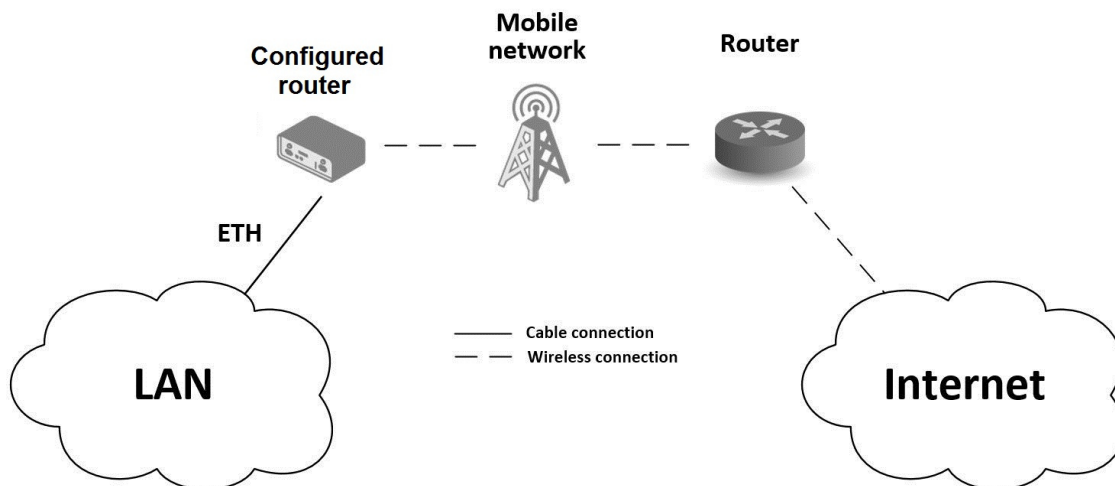

Figure 1: Access to the Internet from LAN

II. Backed up access to the Internet (from LAN)

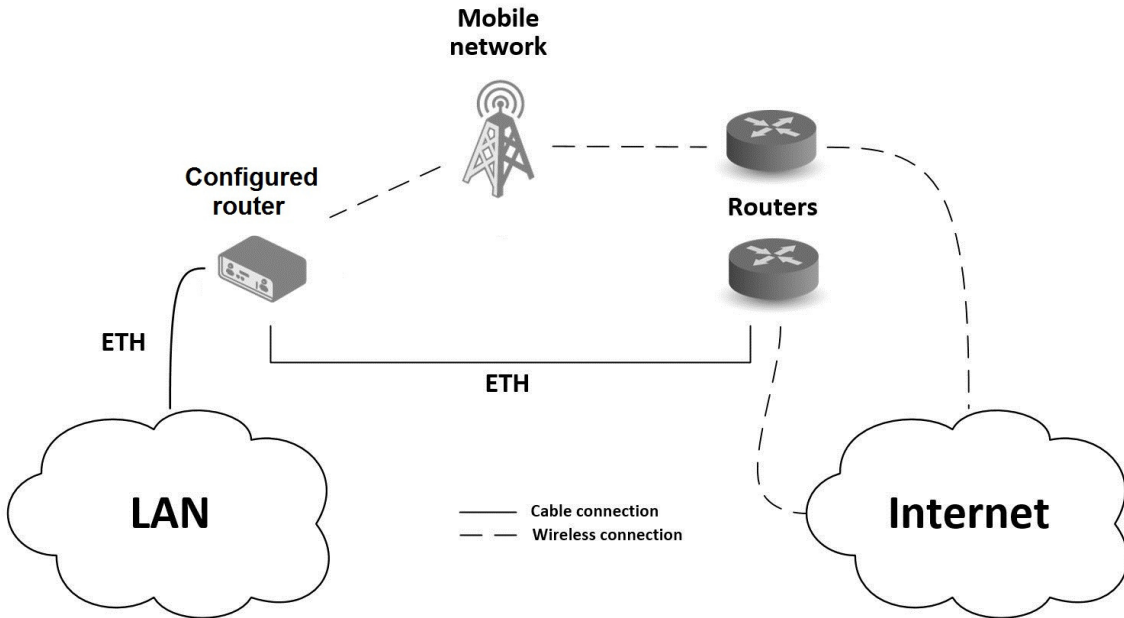

Figure 2: Backed up access to the Internet

III. Secure networks interconnection or using VPN

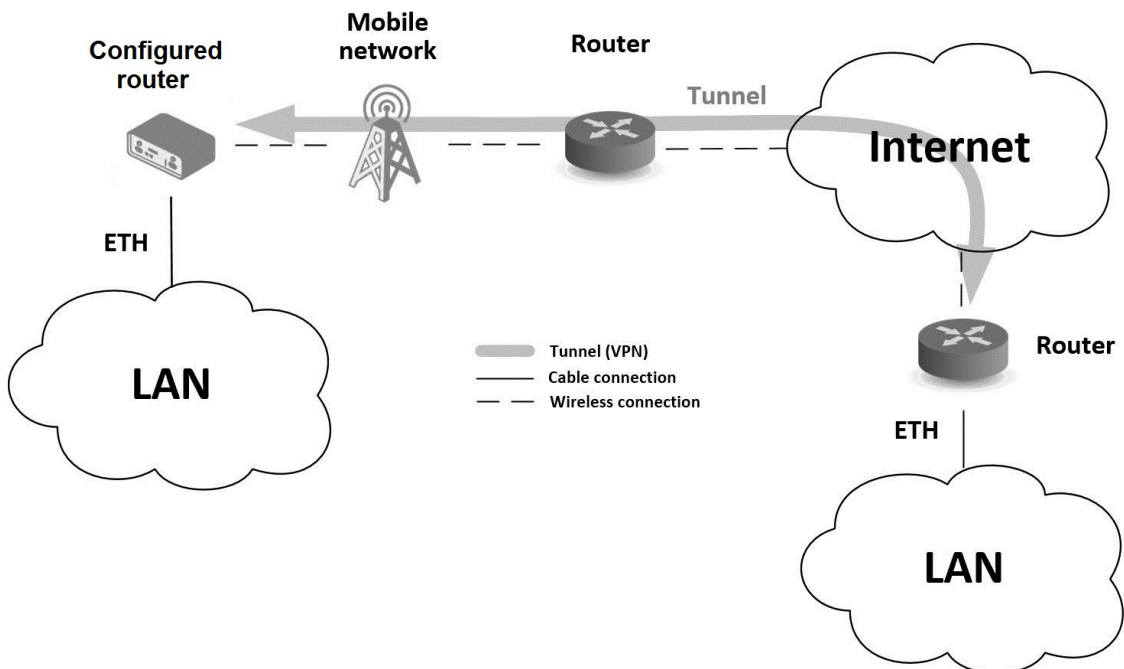

Figure 3: Using VPN tunnel

IV. Serial Gateway

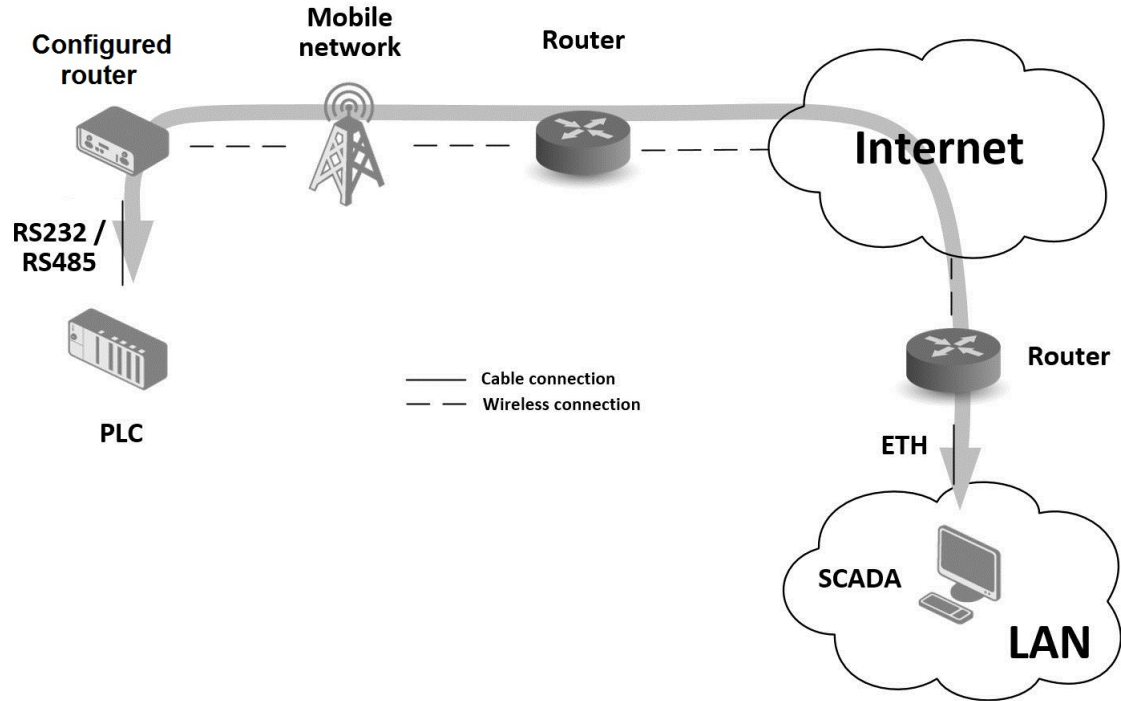

Figure 4: Serial Gateway

4. Contents of Package

The standard set of router includes items listed in following table:







Item#	Description	Figure	Q'ty
1	ICR-3211 router		1 pcs
2	DIN holder (screwed on the router)		1 pcs
3	Wing on wall mounting (screwed on the router)		2 pcs
4	2-pin terminal block for power supply (deployed on the router)		1 pcs
5	10-pin terminal block for RS232, RS485 and I/O (deployed on the router)		1 pcs
6	Printed Quick Start Guide		1 pcs

Table 1: Contents of package

5. Router Design

5.1 Router Versions

ICR-3211 router is supplied in the following versions (see table below). All versions are available in a metal box.

Router versions	SIM	BIN	BOUT	ETH	RS232	RS485
OWL LPWAN	2 x	1 x	1 x	2 x	1 x	1 x

Table 2: Router versions



Figure 5: OWL LPWAN

5.2 Device Labels

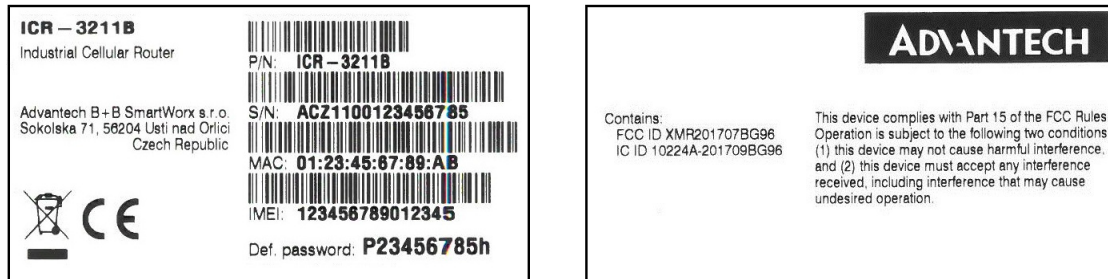

Figure 6: Labels example

5.3 Order Codes

Order codes overview is shown in the table below.

Product type	Product name	Order code	Features – interfaces
ICR-3200	ICR-3211	ICR-3211B	LTE module for NAM, 2x ETH, 1x BI, 1x BO, 1x RS232, 1x RS485, 2x SIM reader

Table 3: Order Codes Overview

5.4 Basic Dimensions of the Router Box (specified in mm)

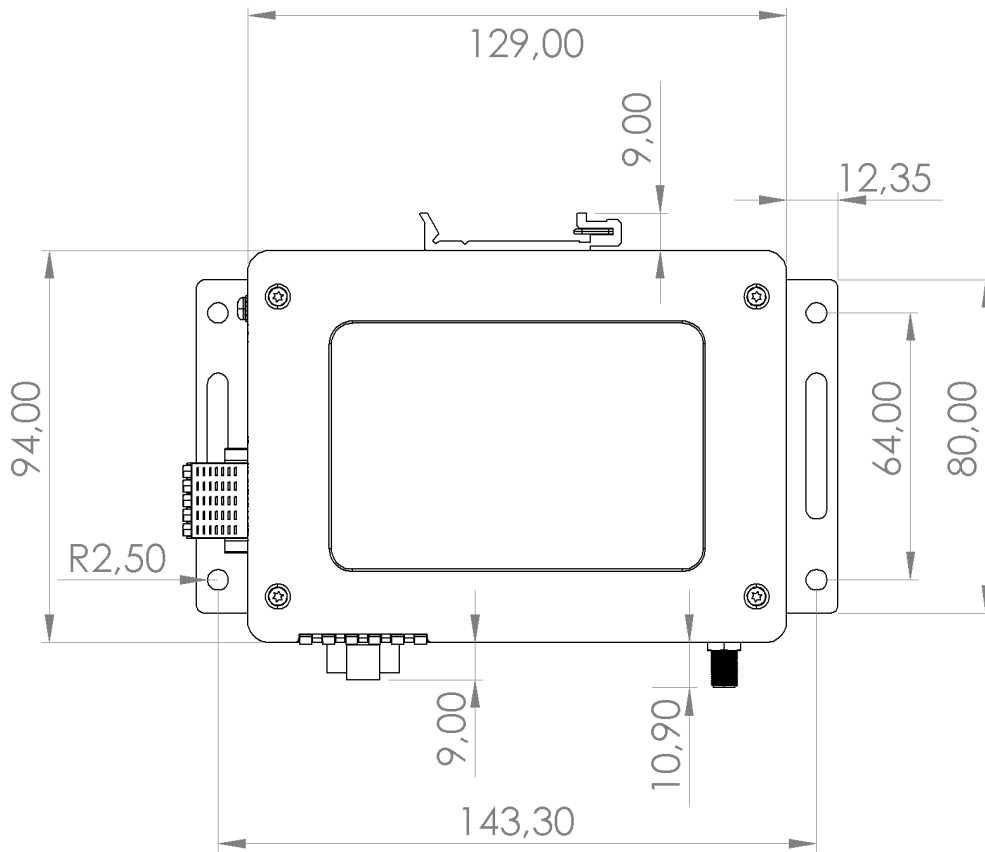

Figure 7: Basic dimensions of the router box

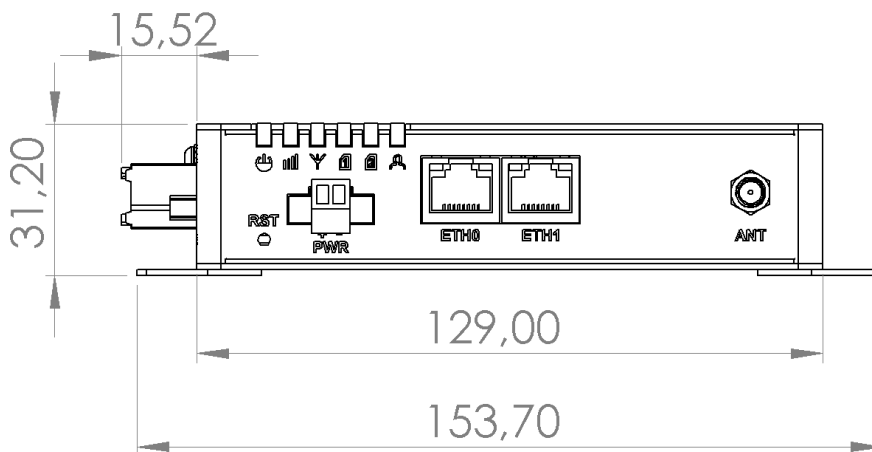

Figure 8: Basic dimensions of the router box

5.5 Mounting Recommendations

Router can be placed:

- on a flat surface,
- on a wall (or other surface) using the side wings,
- on a DIN rail EN 60715 with the included metal DIN rail clip.

For most applications with a built-in router within a switchboard it is possible to recognize two kinds of environments:

- A non-public, industry environment of low voltage with high interference,
- A public environment of low voltage and without high interference.

For both of these environments it is possible to mount router to a switchboard, after which there is no need to have examination immunity or issues in connection with EMC according to EN 61439-1:2011.



If the negative pole of the router is grounded, there is no protection against reversed polarity! The only protection left is the fuse inside the device. Only the service center can restore the router's functionality.



In compliance with the EN 61439-1:2011 specification it is necessary to observe the following assembly instructions for a router attached to a switchboard:

- For whip antennas it is recommended to observe a minimum distance of 6 cm from cables and metal surfaces on every side in order to avoid interference. When using an external antenna separate from the switchboard it is necessary to fit a lightning conductor.
- When mounting a router on sheet-steel we recommend using a "cable" antenna.
- For all cables we recommend to bind the bunch, and for this we recommend:
 - The length of the bunch (combination of power supply and data cables) should be a maximum 1.5 m. If the length of data cables exceeds 1.5 m or if the cable is leading towards the switchboard, we recommend installing surge protectors.
 - Data cables must not have a reticular tension of ~ 230 V/50 Hz or ~ 120 V/60 Hz.
- Sufficient space must be left between individual connectors for the handling of cables,
- To ensure correct functioning of the router we recommend the use of an earth-bonding distribution frame for the grounding of the power supply of the router, data cables and antenna within the switchboard.

5.6 Removing from the DIN Rail



The DIN rail clip is suitable for a DIN rail according to EN 60715 standard only. The default position of metal rail clip, which is used for mounting the router on a DIN rail, is shown in the following figure. Its position can be changed on some models (back or bottom). When changing the position of the DIN rail clip, tighten the screws with max. 0.4 Nm torque.



Figure 9: Default position of DIN rail clip

To remove the router from the DIN rail it is necessary to lightly push down the router so that the bottom part of the DIN rail clip hitched to the DIN rail get out of this rail and then fold out the bottom part of the router away from the DIN rail.

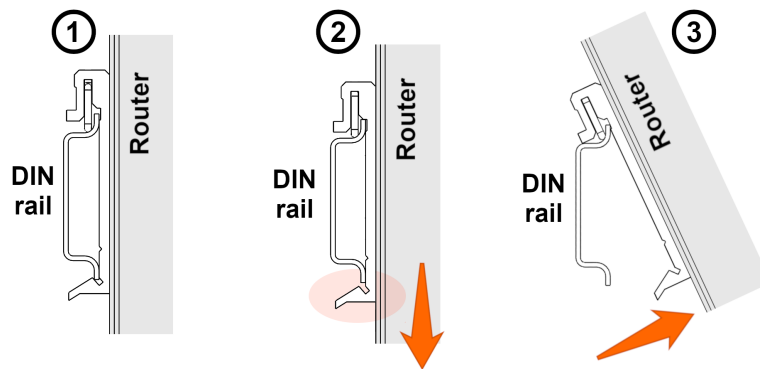

Figure 10: Removing from the DIN rail

5.7 Description of the Front Panel

On the front panel of the router, there are located:

Caption	Connector	Description
RST	—	RST button used to restore the default configuration and re-boot the router
PWR	2-pin	Terminal block for the power supply
ETH0	RJ45	Ethernet connection to the computer network
ETH1	RJ45	Ethernet connection to the computer network
ANT	SMA	Connector for main antenna

Table 4: Description of the front panel

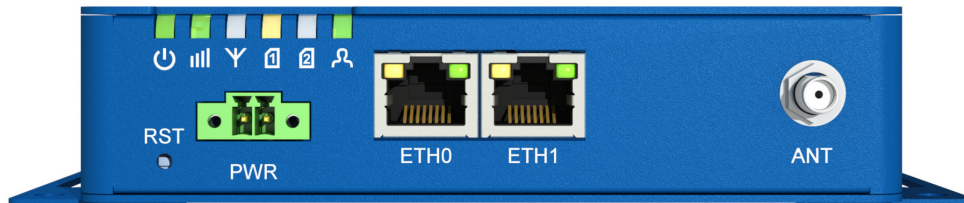

Figure 11: The front panel of the router

5.7.1 Status Indication

There are six LED indicators on the front panel to provide router status information. Each ETH port has two additional LEDs that provide information about the port status.







	Caption	Color	State	Description
	PWR	Green Green Green	On Blinking Fast blinking	Starting of the router Router is ready Updating firmware
	SIG	Green Orange Red	On On On	Good signal Fair signal Poor signal
	DAT	Green	Blinking	Communication in progress on radio channel
	SIM1	Green Green Red Red	Blinking On On Fast blinking	SIM is selected, router waits for data connection 4G technology 2G technology SIM card problem (missing SIM card or PIN code not entered)
	SIM2	Green Green Red Red	Blinking On On Fast blinking	SIM is selected, router waits for data connection 4G technology 2G technology SIM card problem (missing SIM card or PIN code not entered)
	USR	Green	On / Blinking / Fast blinking	Function of this LED diode can be selected by user
	ETH0 ETH1	Green Green	On Off	Selected 100 Mbps Selected 10 Mbps
	ETH0 ETH1	Yellow Yellow Yellow	On Blinking Off	The network cable is connected Data transmission The network cable is not connected

Table 5: Status indication

5.7.2 Power Connector PWR

Terminal block 3.5 mm.

Pin number	Signal mark	Description
1	VCC(+)	Positive pole of DC supply voltage (+9 to +36 V DC)
2	GND(-)	Negative pole of DC supply voltage

Table 6: Connection of power connector

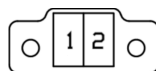

Figure 12: Power connector

Power supply for router is required between +9 V to +36 V DC supply. Protection against reversed polarity without signaling is built into the router.



If the negative pole of the router is grounded, there is no protection against reversed polarity! The only protection left is the fuse inside the device. Only the service center can restore the router's functionality.

For correct operation it is necessary that the power source is able to supply a peak current of 1.2 A.



Unit has to be supplied by a power supply specified as a Limited Power Source (LPS) or CEC/NEC Class 2 source of supply.



In applications requiring low power consumption (such as solar power - not 7/24 mode) is strictly recommended to use "LPM" mode prior to powering down the entire router.

Circuit example:

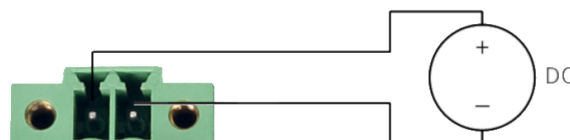

Figure 13: Connection of power supply



All metal parts, including the box, are connected together with the negative pole of power supply (common pole). To ground the router can be used the grounding screw located on the left panel.

5.7.3 Ethernet Port ETH0 and ETH1

The panel socket of RJ45 is used for this interface. The insulation strength of Ethernet ports from each other and from the rest of the router (grounding) is 1500 V.

Pin	Signal mark	Description	Data flow direction
1	TXD+	Transmit Data – positive pole	Input/Output
2	TXD-	Transmit Data – negative pole	Input/Output
3	RXD+	Receive Data – positive pole	Input/Output
4	—	—	
5	—	—	
6	RXD-	Receive Data – negative pole	Input/Output
7	—	—	
8	—	—	

Table 7: Connection of Ethernet connector

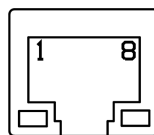

Figure 14: Ethernet connector

The Ethernet cable plugs into the RJ45 connectors labeled as ETH0 and ETH1 (see figure below).

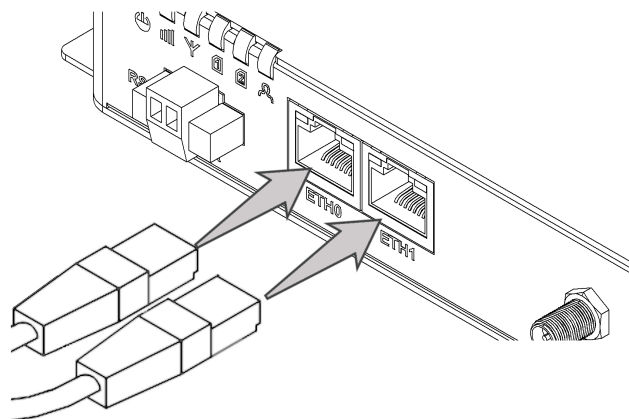

Figure 15: Connection of Ethernet cables

5.7.4 Antenna Connector ANT

The *ANT* connector is used to connect the main antenna to the router.



The router can not operate without a main antenna connected through the port marked as *ANT*.



The SMA connector is used for the connection of the antenna. Recommended tightening moment for screwing the antenna to SMA connectors is 0.9 Nm.

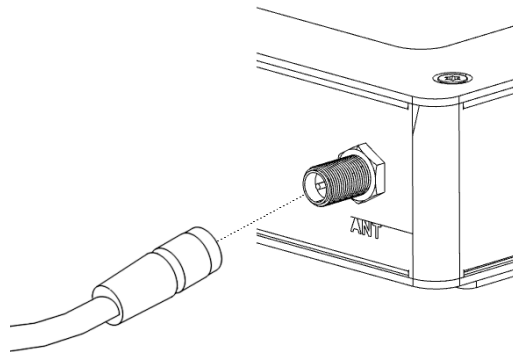

Figure 16: Connecting the antenna

5.7.5 Reset Button

The *RST* button on the front panel has three functions on ICR-3200 routers:

- Reboot the router:

Hold the *RST* button for less than 4 seconds, the router will be restarted.

- Factory reset – restore the default configuration:

Hold the *RST* button for more than 4 seconds. The *PWR* LED turns off and on again. We recommend holding down the *RST* button for 1 second after turning on the *PWR* LED on the front panel.

- Factory reset – restore the default configuration when unable to boot:

If the router is unable to boot due to a bad configuration, turn off the router (power supply). Push and hold the *RST* button, turn on the router and hold the *RST* button for at least 10 seconds. This will return the router to default configuration.



Before performing the factory reset of the router, it is recommended to back up the router configuration settings (see Configuration manual for ICR-3200 routers) because reset of the router will return all configuration settings to their default states.



In order to press the *RST* button it is necessary to use a narrow screwdriver or any other small tool.



Figure 17: Router reset

Action	Router behavior	Trigger events – options
Reboot	Turns off and then turns on the router	<ul style="list-style-type: none"> • Disconnect and reconnect the power • Send text <i>reboot</i> via SMS to SIM card number put in your router (your phone number has to be authorized – see the Configuration Manual for ICR-3200 routers) • Press the <i>Reboot</i> menu item in the Web interface • Press the <i>RST</i> button, hold less than 4 seconds
Reset (factory)	Restores the default configuration and reboots the router	<ul style="list-style-type: none"> • Hold the <i>RST</i> button for more than 4 seconds • If it does not help (router does not start at all), turn off the router (power supply). Push and hold the <i>RST</i> button, then turn on the router and hold the <i>RST</i> button for more than 10 seconds.

Table 8: Overview of router reboot and reset

5.8 Description of the Left Panel

Interfaces located on the left panel are described in the table below.

Caption	Connector	Description
Grounding screw	M3 screw	Grounding screw (M3x6L) is connected to the ground of the board and to the negative pole of the power source.
SIM cards	2FF size	Unscrew the SIM cards cover to access the SIM1 and SIM2 slots.
SERIAL I/O	10-pin	This connector has the RS232 and RS485 serial interfaces, one binary input and one binary output. The connector pinout is printed on the top label.

Table 9: Description of the left panel

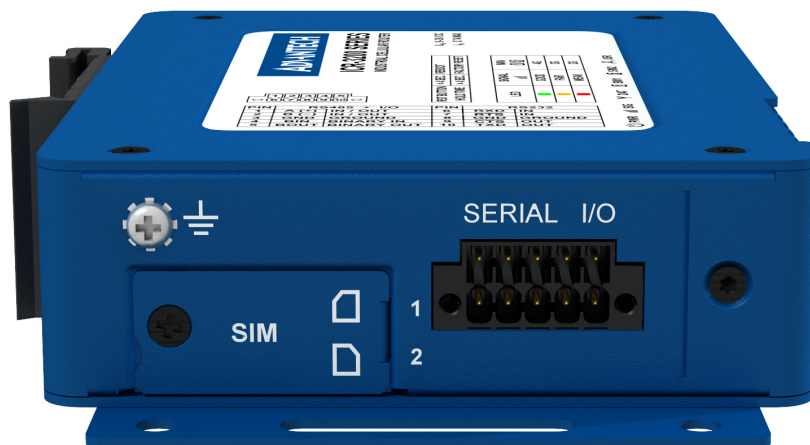

Figure 18: The left panel of the router

5.8.1 SIM Card Reader

Two SIM card readers for 3 V and 1.8 V SIM cards are located on the left panel of the router. In order for the router to function, it is necessary to insert an activated SIM card with an unblocked PIN code, or you can enter the PIN code in the router web interface. The SIM cards may have different adjusted APNs (Access Point Names).



Type of SIM cards: Mini SIM (2FF) 25.0 x 15.0 x 0.76 mm.

Changing the SIM card:



- Always disconnect the router from power supply before handling the SIM card!
- Unscrew the SIM card cover.
- Using a plastic opening tool, or your fingernail, press the SIM card slightly into its slot until you hear a click.
- After hearing this click, release the card and it will pop out of its slot.
- Remove the SIM card and push any other SIM card into the slot until it clicks into place.

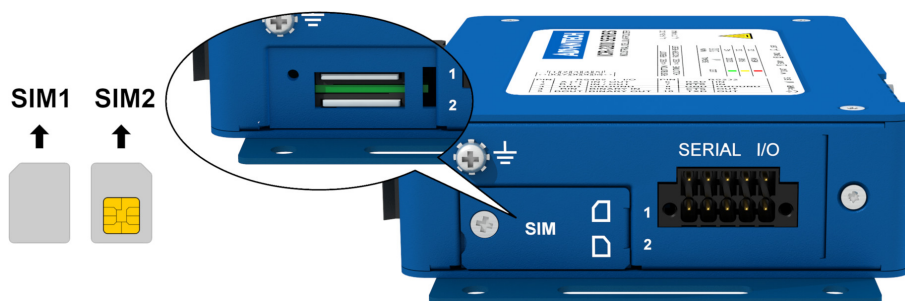

Figure 19: SIM card reader



For Verizon Wireless network, SMS messages will be transmitted successfully only if both of the end devices are equipped with an LTE Cat-M cellular module.

5.8.2 Serial Interfaces and I/O Port

The RS232 and RS485 serial interfaces together with the I/O interface are physically connected to the 10-pin panel socket. All three interfaces are not isolated from the router. The pinout of this connector is described in the tables below.

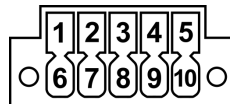

Figure 20: Serial + I/O connector

Pin	Signal mark	Description
1	B (+)	IN/OUT
2	A (-)	IN/OUT
3	GND	GROUND

Table 10: Connection of RS485

Pin	Signal mark	Description
4	BIN	BINARY IN
5	BOUT	BINARY OUT

Table 11: Connection of I/O

Pin	Signal mark	Description
6	RXD	IN
7	CTS	IN
8	GND	GROUND
9	RTS	OUT
10	TXD	OUT

Table 12: Connection of RS232

The I/O user interface is designed for binary input processing and binary output control. By default, the binary output is open, so it is not grounded. The maximum binary output load is 36 V at 500 mA. The constant current supplied by the binary input is 3 mA.

The functional scheme of connection for the binary input and binary output is drawn on the picture below.

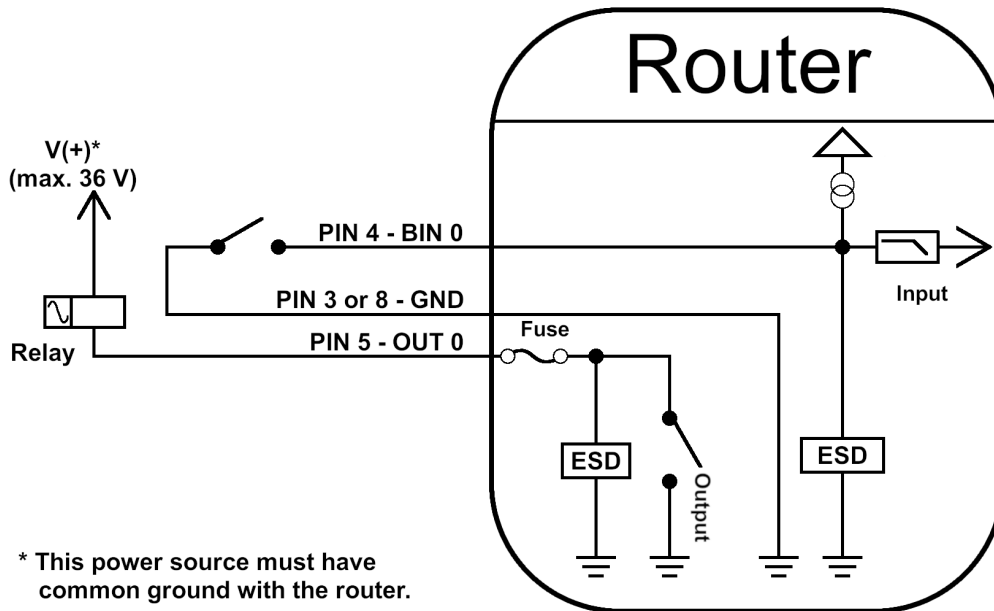

Figure 21: Functional scheme of the binary interface

6. First Use

6.1 Connecting the Router Before First Use

Before putting the router into operation it is necessary to connect all of the components that are required to run your applications. Don't forget to insert a SIM card.



The router can not operate without a connected antenna, SIM card and power supply. If the antenna is not connected, the router may be damaged.

6.2 Start

The router will start when a power supply is connected to the router. By default, the router will automatically start to log on to the default APN. The DHCP server will start to assign addresses for devices connected through the Ethernet port ETH0. Router's behavior can be changed via the web interface. This is described in detail in the *Configuration manual for ICR-3200 routers*.

6.3 Configuration



Attention! If no SIM card is inserted in the router, it is not possible for the router to operate. Any inserted SIM card must have active data transmission.

6.3.1 Configuration by Web Browser

For status monitoring, configuration and administration of the router a web interface is available which can be accessed by entering the IP address of the router into the web browser. The default IP address of the router is 192.168.1.1. **It is necessary to use the HTTPS protocol for secure communication over a network.**

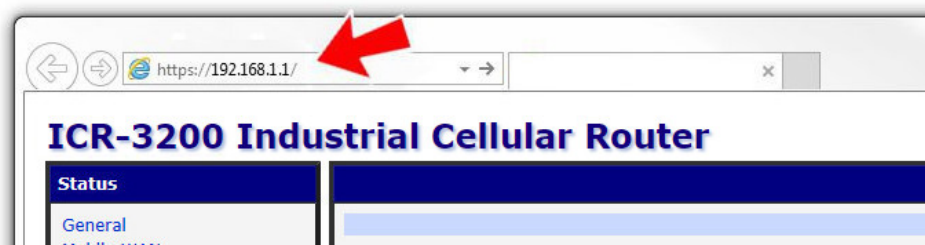

Figure 22: Entering the IP address of the router

By default, configuration of the router can only be performed with the default username "**root**". The default password is printed on the router's label.* Change the default password as soon as possible!

Figure 23: Entering login information

After successfully entering login information, the user will have access to the router web interface via their browser.

Status	General Status
<ul style="list-style-type: none"> General Mobile WAN Network DHCP IPsec DynDNS System Log 	<p>Mobile Connection</p> <p>SIM Card : 1st IP Address : 10.80.0.62 IPv6 Address : Unassigned Rx Data : 580 B Tx Data : 843 B Uptime : 0 days, 14 hours, 1 minute</p> <p>» More Information «</p> <p>Primary LAN</p> <p>IP Address : 10.64.0.65 / 255.255.252.0 IPv6 Address : fd00:a40:165 / 56 MAC Address : C8:DF:84:C3:65:43 Rx Data : 179.9 KB Tx Data : 144.7 KB</p> <p>» More Information «</p> <p>Secondary LAN</p> <p>IP Address : 10.65.0.65 / 255.255.252.0 IPv6 Address : fd00:a41:165 / 56 MAC Address : C8:DF:84:C3:65:45 Rx Data : 120.0 KB Tx Data : 680 B</p> <p>» More Information «</p> <p>Peripheral Ports</p> <p>Expansion Port 1 : RS-232 Expansion Port 2 : RS-485 Binary Input : Off Binary Output : On</p> <p>System Information</p> <p>Firmware Version : 6.1.8 (2018-08-06) BETA #458 Serial Number : N/A Profile : Standard RTC Battery : Ok Supply Voltage : 24.1 V Temperature : 43 °C Time : 2018-08-08 09:53:02 Uptime : 0 days, 14 hours, 1 minute</p> <p>» Licenses «</p>
<p>Configuration</p> <ul style="list-style-type: none"> LAN VRRP Mobile WAN PPPoE Backup Routes Static Routes Firewall NAT OpenVPN IPsec GRE L2TP PPTP Services Expansion Port 1 Expansion Port 2 Scripts Automatic Update 	
<p>Customization</p> <ul style="list-style-type: none"> User Modules 	
<p>Administration</p> <ul style="list-style-type: none"> Users Change Profile Change Password Set Real Time Clock Set SMS Service Center Unlock SIM Card Unblock SIM Card Send SMS Backup Configuration Restore Configuration Update Firmware Reboot Logout 	

Figure 24: Router web interface



A detailed description of the router settings in the Web interface can be found in the *Configuration manual for ICR-3200 routers*.

*If the router's label does not contain a unique password, use the password "root".

7. Technical Parameters

7.1 Basic Parameters

Router parameters		
Temperature range	Operating Storage	-40 °C to +75 °C -40 °C to +85 °C
Humidity	Operating Storage	0 to 95 % relative humidity non condensing 0 to 95 % relative humidity non condensing
Altitude	Operating	2000 m / 70 kPa
Degree of protection		IP30
Supply voltage		9 to 36 V DC
Battery for RTC		CR1225
Consumption	Idle Average Peak Sleep mode	2,5 W 4 W 11 W 0.085 W
Dimensions of device		31,2 x 94 x 129 mm
DIN rail clip dimensions		DIN 35 mm, EN 60715
Weight	Metal box	477 g
Antenna connectors		1x SMA for LTE – 50 Ω
User interface	2x ETH SERIAL I/O	Ethernet RJ-45 (10/100 Mbit/s) 10-pin panel socket Terminal Block (for RS232, RS485 and I/O)

Table 13: Basic parameters

7.2 Standards and Regulations

The router complies with the following standards and regulations:

Standards and regulations	
Radio	PTCRB, EN 301 511, EN 301 908-1, EN 301 908-13, EN 303 413
EMC	EN 301 489-1, EN 301 489-19, EN 301 489-52, EN 61000-6-2, EN 61000-6-4, FCC 15.107 Class B, FCC 15.109 Class B, IC
Safety	EN 60 950-1:2006 + A11:2009 + A1:2010 + A12:2011 + A2:2013 + AC:2011
Transportation	EN 45545-2
Carrier approvals	Verizon, AT&T
National	FCC, IC, CE compliant
Environmental	REACH, RoHS3 and WEEE compliant

Table 14: Standards and regulations

7.3 Type Tests and Environmental Conditions

Phenomena	Test	Description	Test levels
ESD	EN 61000-4-2	Enclosure contact Enclosure air	± 6 kV (crit. A) ± 8 kV (crit. A)
RF field AM modulated	EN 61000-4-3	Enclosure	10 V/m (crit. A) (80 – 2700 MHz) 3 V/m (crit. A) (2700 – 6000 MHz)
Fast transient	EN 61000-4-4	Signal ports Power ports Ethernet ports	± 1 kV (crit. A) ± 2 kV (crit. A) ± 1 kV (crit. A)
Surge	EN 61000-4-5	Ethernet ports Power ports	± 1 kV (crit. A), shielded cab. ± 0,5 kV (crit. A)
RF conducted	EN 61000-4-6	All ports	10 V/m (crit. A) (0,15 – 80 MHz)
Radiated emission	EN 55032	Enclosure	Class B
Conducted emission	EN 55032	DC power ports Ethernet ports	Class B Class B
Dry heat	EN 60068-2-2 MIL-STD-810G SAE J1455	+75 °C *, 40 % rel. humidity	
Cold	EN 60068-2-1 MIL-STD-810G SAE J1455	-40 °C *	
Dump heat	EN 60068-2-78 MIL-STD-810G SAE J1455	95 % rel. humidity (+40 °C)	
Vibration	EN 60068-2-64 ed. 2 MIL-STD-810G SAE J1455	Vibration spectrum A.3 (rolling stock)	Category 1 (3 axis, 8 hours per axis)
Shock	EN 60068-2-27 ed. 2 MIL-STD-810G SAE J1455	half-sine, 50 g peak, 11 ms	

Table 15: Type tests and environmental conditions

7.4 Technical Parameters of Cellular Module

Technical parameters of cellular module	
LTE parameters	LTE: Cat.M1 FDD frequencies: B12, B13, B28 (700 MHz), B20 (800 MHz), B5, B18, B19, B26 (850 MHz), B8 (900 MHz), B4 (1700 MHz), B3 (1800 MHz), B2 (1900 MHz), B1 (2100 MHz) TDD frequencies: B39 (1900 MHz) LTE bit rates: 375 Kbps (DL) / 375 Kbps (UL)
EDGE parameters	Supported frequencies: 850 MHz, 900 MHz, 1800 MHz, 1900 MHz EDGE bit rates: 296 Kbps (DL) / 236,8 Kbps (UL)
GPRS parameters	Supported frequencies: 850 MHz, 900 MHz, 1800 MHz, 1900 MHz GPRS bit rates: 107 Kbps (DL) / 85,6 Kbps (UL)

Table 16: Technical parameters of cellular module

Antenna Requirements

- VSWR: <2:1 (Antenna input impedance response as function of frequency. This shows the antenna resonances and its bandwidth).
- SMA: 50 Ω

7.5 Other Technical Parameters

Other technical parameters	
CPU power	2 DMIPS per MHz
Flash memory	Available memory space 1862 MB <ul style="list-style-type: none"> • 2x 256 MB – FW • 512 MB – User data storage • 838 MB – Space for User Modules
RAM	512 MB

Table 17: Other technical parameters

8. Recommended Literature

- [1] Advantech B+B SmartWorx: **Start Guide** (QSG-0006-EN)
- [2] Advantech B+B SmartWorx: **ICR-3200 – Configuration Manual** (MAN-0042-EN)



Product related documents can be obtained on *Engineering Portal* at <https://ep.advantech-bb.cz/> address.

9. Troubleshooting



If you cannot connect to the router from your PC, your network card may be configured in such a way that it is not possible to connect to the router. Take one or more of the following steps in order to solve the problem:

- Make sure your PC's network card is configured to obtain the IP address from the DHCP server (by default the DHCP server is running in the router).
- Set the communication rate to 10 MB/s in the properties of your network card.
- Connect the router to the PC via Switch.
- Connect the router to the PC, start the router first and then start the PC after the router's initialization.

9.1 FAQ

The router reboots itself and the Ethernet connection fails.

- *The router will not work well without an antenna. Keep the antenna as far as possible from the power supply.*

Ethernet connection fails or is not establishing.

- *It is possible to turn auto negotiation off and set a rate and duplex manually on the Ethernet interface of the router. Available on "LAN Configuration" page in the router.*

Mobile WAN connection fails.

- *Check the signal power ("Mobile WAN status" page). If the signal power is weak, you will have to use a better antenna. If the neighbouring cells have a similar signal strength, you will need to use a directional antenna. For proper operation, the signal levels have to be good.*
- *Try to enable automatic ping from the router, which will check the connection when there are no data running and in the case of a failed ping, restart the connection. This can be done on the "Mobile WAN Configuration" page in the router in the "Check connection" section. "Enable + bind" option is to ensure the ping goes always through Mobile WAN network interface.*

Mobile WAN connection cannot be established.

- *Check the "Mobile WAN Configuration" – APN, name, password and IP address (all can be blank).*
- *Try to enter the SIM card PIN – verify that the SIM card has the PIN code entered. Available on "Unlock SIM Card" page in the "Administration" section.*

- *In a private APN it is not recommended to get the DNS settings from operator (on "Mobile WAN" page)*
- *Go to "System Log" page in "Status" section and observe where the error occurs.*

 **I cannot connect from the Internet to the device behind the router. I have NAT enabled.**

- *The device's gateway has to be configured so it points to the router.*

 **I can't access my Web server placed behind the router over NAT.**

- *The remote HTTP access to the router has to be disabled on "NAT Configuration" page in the router. Also enable "Send all remaining incoming packets to default server" feature and fill in the IP address of your Web server. On the Web server, the default gateway has to be the IP address of the router.*

 **DynDNS doesn't work.**

- *With private APN this will not work.*
- *If the same IP address is recorded in your canonic name as a dynamically assigned address, it means that the operator is using NAT or a firewall.*
- *You can verify NAT using ping to your server with static address and then compare with router's IP address.*
- *You can verify a Firewall by accessing remotely to the router's Web interface.*
- *The operator may not provide the address of DNS server and without DNS server's address it is impossible to connect to the dyndns.org server. The following messages will be shown in the System Log:*
 - *DynDNS daemon started*
 - *Error resolving hostname: no such file or directory*
 - *Connect to DynDNS server failed*

 **L2TP or IPSec isn't establishing.**

- *Check the "System Log" page for error messages.*

 **IPSec tunnel establishes but the communication does not run.**

- *Probably there are bad routing rules defined in the connected devices, or the default gateway.*

 **I switched the router to offline mode by SMS message, but the router is in online mode after reboot.**

- *SMS messages do not change the router configuration. They remain in effect only until the router is rebooted.*

Serial communication is not working.

- *Verify that the router model supports serial communications. Also verify the serial communication settings. To do so, open the router's configuration menu via the web browser, select the appropriate "Expansion Port" from "Configuration" part of the menu and verify the settings.*

Is the router Cisco compatible? Can I use the Cisco configuration?

- *No, the Firmware in the router (Conel OS) is based on Linux with BusyBox. Thus the Cisco configuration cannot be used. But network connections are defined by standards so connecting the router to the Cisco or other networking devices is possible and will be compatible.*

FTP or SFTP does not work

- *FTP will work on v2 routers only. You can use SFTP on all routers to transfer files to/from the router. If having troubles with FTP on v2 routers, make sure you have FTP enabled: "Configuration" section, "Services", "FTP". Then you can connect with any client on port 21 with name and password same as for the Web interface. If having troubles with SFTP, make sure you have SSH enabled: "Configuration" section, "Services", "SSH". Then you can connect with any client on port 22 with name and password same as for the Web interface.*

How can I connect to the router's command line? (SSH, Telnet)

- *You can use SSH on all routers or Telnet on v2 routers only. SSH is enabled by default, but you can verify in Web interface in "Configuration" section, "Services", "SSH". Then connect with any SSH client on port 22 of the router. User and password is the same as for the Web interface. Telnet on v2 routers can be enabled here: "Configuration" section, "Services", "Telnet".*

10. Customers Support

10.1 Customer Support for NAM

E-mail: support@advantech-bb.com

Web: www.advantech-bb.com

10.2 Customer Support for Europe

E-mail: iiotcustomerservice@advantech.eu

Web: www.advantech-bb.com

10.3 Customer Support for Asia

E-mail: icg.support@advantech.com.tw

Web: www.advantech.com



Upkeep – Advices:

- The SIM-card must be handled carefully as with a credit card. Don't bend, don't scratch on this and do not expose to static electricity.
- During cleaning of the router do not use aggressive chemicals, solvents and abrasive cleaners!

CE Hereby, Advantech B+B SmartWorx s.r.o. company declares that the radio equipment narrated in this user's guide is in compliance with EU Directive **2014/53/EU**.

The full text of the EU Declaration of Conformity is available at the following internet address:
www.advantech-bb.cz/eudoc