

ioLogik R1200 Series User's Manual

Edition 3.3, February 2018

www.moxa.com/product



© 2018 Moxa Inc. All rights reserved.

ioLogik R1200 Series User's Manual

The software described in this manual is furnished under a license agreement and may be used only in accordance with the terms of that agreement.

Copyright Notice

© 2018 Moxa Inc. All rights reserved.

Trademarks

The MOXA logo is a registered trademark of Moxa Inc.
All other trademarks or registered marks in this manual belong to their respective manufacturers.

Disclaimer

Information in this document is subject to change without notice and does not represent a commitment on the part of Moxa.

Moxa provides this document as is, without warranty of any kind, either expressed or implied, including, but not limited to, its particular purpose. Moxa reserves the right to make improvements and/or changes to this manual, or to the products and/or the programs described in this manual, at any time.

Information provided in this manual is intended to be accurate and reliable. However, Moxa assumes no responsibility for its use, or for any infringements on the rights of third parties that may result from its use.

This product might include unintentional technical or typographical errors. Changes are periodically made to the information herein to correct such errors, and these changes are incorporated into new editions of the publication.

Technical Support Contact Information

www.moxa.com/support

Moxa Americas

Toll-free: 1-888-669-2872
Tel: +1-714-528-6777
Fax: +1-714-528-6778

Moxa Europe

Tel: +49-89-3 70 03 99-0
Fax: +49-89-3 70 03 99-99

Moxa India

Tel: +91-80-4172-9088
Fax: +91-80-4132-1045

Moxa China (Shanghai office)

Toll-free: 800-820-5036
Tel: +86-21-5258-9955
Fax: +86-21-5258-5505

Moxa Asia-Pacific

Tel: +886-2-8919-1230
Fax: +886-2-8919-1231

Table of Contents

1. Overview	1-1
Introduction	1-2
Product Features	1-2
Package Checklist	1-2
Product Model Information	1-2
Ordering Information	1-2
Specifications	1-3
Common Specifications	1-3
ioLogik R1210	1-4
ioLogik R1212	1-4
ioLogik R1214	1-5
ioLogik R1240	1-6
ioLogik R1241	1-6
Physical Dimensions	1-7
Hardware Reference	1-7
Panel Guide	1-7
LED Indicators	1-8
Switch Settings	1-8
DI Circuit Diagram	1-8
DIO Circuit Diagram	1-9
Relay Circuit Diagram	1-10
AI Circuit Diagram	1-10
2. Initial Setup	2-1
Hardware Installation	2-2
Connecting the Power	2-2
Grounding the ioLogik R1200	2-2
Connecting to Serial Interface	2-2
Mounting the ioLogik R1200	2-2
Connecting to Digital Sensors and Devices	2-3
RS-485 Networks	2-4
Modbus/RTU Devices	2-5
Dual RS-485 or Repeater Settings	2-5
Jumper Settings (DIO and AI)	2-6
Pull High/Low DIP Switch Settings for the RS-485 Port	2-6
Software Installation	2-7
ioSearch Installation	2-7
Initial Setup by USB	2-9
Restore Factory Default Settings	2-10
3. Using ioSearch	3-1
Introduction to ioSearch	3-2
ioSearch Main Screen	3-2
Main Screen Overview	3-2
ioSearch Setup	3-3
System	3-3
Sort	3-5
Help	3-6
Quick Links	3-6
Main Functions	3-6
Locate	3-6
Connect/Disconnect	3-6
Firmware Upgrade	3-7
Import	3-7
Export	3-7
Change Server Name	3-7
Restart System	3-8
Delete ioLogik Device	3-8
Reset to Default	3-8
Main Screen	3-9
I/O Configuration Tab (General)	3-9
Configuring Digital Input Channels	3-9
Configuring Digital Output Channels	3-11
Configuring Analog Input Channels	3-13
AI Input Range	3-13
Configuring Analog Output Channels	3-14
Server Info Tab	3-16
Server Settings Tab (General)	3-17
Watchdog	3-18

A. Modbus Mapping	A-1
ioLogik R1200 System Modbus Address and Register Map	A-2
ioLogik R1210 Modbus Address and Register Map	A-3
ioLogik R1212 Modbus Address and Register Map	A-11
ioLogik R1214 Modbus Address and Register Map	A-24
ioLogik R1240 Modbus Address and Register Map	A-31
ioLogik R1241 Modbus Address and Register Map	A-36
B. Factory Defaults	B-1
C. Pinouts	C-1
D. FCC Interference Statement	D-1
E. European Community (CE)	E-1

The following topics are covered in this chapter:

- **Introduction**
- **Product Features**
- **Package Checklist**
- **Product Model Information**
 - Ordering Information
- **Specifications**
 - Common Specifications
 - ioLogik R1210
 - ioLogik R1212
 - ioLogik R1214
 - ioLogik R1240
 - ioLogik R1241
- **Physical Dimensions**
- **Hardware Reference**
 - Panel Guide
 - LED Indicators
 - Switch Settings
 - DI Circuit Diagram
 - DIO Circuit Diagram
 - Relay Circuit Diagram
 - AI Circuit Diagram

Introduction

The ioLogik R1200 is an industrial grade, wide-temperature serial remote I/O device equipped with dual RS-485 ports that allow users to select between two RS-485 serial ports or switch to a built-in repeater. Applications such as factory automation, security and surveillance systems, and tunnel monitoring can use the RS-485 serial line to set up multi-drop device configurations through serial cables. Furthermore, a technician with no serial background can upload device configurations and firmware via USB at the field site without bringing a PC to the field site. The ioLogik R1200 lets you easily build an industrial grade, long distance communication system with standard PC hardware, and extends the communication distance by 4,000 ft. (1,200 m).

Product Features

- Upload and install device configurations and firmware via USB
- Multi-drop support for device configuration and firmware upgrade via RS-485
- Remote firmware updates via RS-485
- Dual RS-485 ports with built-in repeater
- Wide temperature (-40 to 85°C), 1 kV surge protection, and 3 kV I/O isolation between I/O channels, networks and power circuits
- Multi-functional I/O support for DI, event counter, DO, and pulse output
- Modbus/RTU support for control by SCADA software, including Wonderware InTouch and GE Intellution iFix32
- Monitoring and configuration via ioSearch Windows utility
- Hardware detection over RS-485 via ioSearch

Package Checklist

The ioLogik R1200 is shipped with the following items:

- 1 ioLogik R1200 remote I/O product
- Quick Installation Guide (printed)

NOTE	Contact your sales representative if any of the above items are missing or damaged.
-------------	---

Product Model Information

Ordering Information

ioLogik R1210	RS-485 remote I/O, 16 DIs, -10 to 75°C operating temperature.
ioLogik R1210-T	RS-485 remote I/O, 16 DIs, -40 to 85°C operating temperature.
ioLogik R1212	RS-485 remote I/O, 8 DIs, 8 DIOs, -10 to 75°C operating temperature.
ioLogik R1212-T	RS-485 remote I/O, 8 DIs, 8 DIOs, -40 to 85°C operating temperature.
ioLogik R1214	RS-485 remote I/O, 6 DIs, 6 Relays, -10 to 75°C operating temperature.
ioLogik R1214-T	RS-485 remote I/O, 6 DIs, 6 Relays, -40 to 85°C operating temperature.
ioLogik R1240	RS-485 remote I/O, 8 AIs, -10 to 75°C operating temperature.
ioLogik R1240-T	RS-485 remote I/O, 8 AIs, -40 to 85°C operating temperature.
ioLogik R1241	RS-485 remote I/O, 4 AOs, -10 to 75°C operating temperature.
ioLogik R1241-T	RS-485 remote I/O, 4 AOs, -40 to 85°C operating temperature.

Specifications

Common Specifications

Serial Communication

Interface: RS-485-2w: Data+, Data-, GND (5-contact terminal block)

Serial Line Protection: 15 kV ESD for all signals, Level 2 surge, EN 61000-4-5 (1 kV)

Serial Communication Parameters

Parity: None, Even, Odd (default = None)

Data Bits: 8

Stop Bits: 1, 2 (default = 1)

Baudrate: 1200 to 921.6 kbps (default = 9600)

Pull High/Low Resistor for RS-485: 1 k Ω , 150 k Ω

Protocols: Modbus RTU

Physical Characteristics

Wiring: I/O cable max. 16 AWG

Dimensions: 27.8 x 124 x 84 mm (1.09 x 4.88 x 3.31 in)

Environmental Limits

Operating Temperature:

Standard Models: -10 to 75°C (14 to 167°F)

Wide Temp. Models: -40 to 85°C (-40 to 185°F)

Storage Temperature: -40 to 85°C (-40 to 185°F)

Ambient Relative Humidity: 5 to 95% (non-condensing)

Standards and Certifications

Safety: UL 508

EMI:

EN 55032, EN 61000-3-2, EN 61000-3-3, FCC Part 15 Subpart B Class A

EMS:

EN 55024, IEC 61000-4, IEC 61000-6

Shock: IEC 60068-2-27

Freefall: IEC 60068-2-32

Vibration: IEC 60068-2-6

Warranty

Warranty Period: 5 years (excluding the ioLogik R1214)

Details: See www.moxa.com/warranty

ioLogik R1210

Inputs and Outputs

Digital Inputs: 16 channels

Isolation: 3K VDC or 2K Vrms

Digital Input

Sensor Type: Wet Contact (NPN or PNP), Dry Contact

I/O Mode: DI or Event Counter

Dry Contact:

- On: short to GND
- Off: open

Wet Contact (DI to COM):

- On: 10 to 30 VDC
- Off: 0 to 3 VDC

Common Type: 8 points per COM

Counter Frequency: 2.5 kHz, power off storage

Digital Filtering Time Interval: Software selectable

Power Requirements

Power Input: 24 VDC nominal, 12 to 48 VDC

Power Consumption: 154 mA @ 24VDC

ioLogik R1212

Inputs and Outputs

Digital Inputs: 8 channels

Configurable DIOs: 8 channels

Isolation: 3K VDC or 2K Vrms

Digital Input

Sensor Type: Wet Contact (NPN or PNP), Dry Contact

I/O Mode: DI or Event Counter

Dry Contact:

- On: short to GND
- Off: open

Wet Contact (DI to COM):

- On: 10 to 30 VDC
- Off: 0 to 3 VDC

Common Type: 8 points per COM

Counter Frequency: 2.5 kHz, power off storage

Digital Filtering Time Interval: Software selectable

Digital Output

Type: Sink

I/O Mode: DO or Pulse Output

Pulse Output Frequency: 5 kHz

Over-voltage Protection: 45 VDC

Over-current Protection: 2.6 A (4 channels @ 650 mA)

Over-temperature Shutdown: 175°C (typical), 150°C (min.)

Current Rating: 200 mA per channel

Power Requirements

Power Input: 24 VDC nominal, 12 to 48 VDC

Power Consumption: 187 mA @ 24VDC

ioLogik R1214

Inputs and Outputs

Digital Inputs: 6 channels

Relay Outputs: 6 channels

Isolation: 3K VDC or 2K Vrms

Digital Input

Sensor Type: Wet Contact (NPN or PNP), Dry Contact

I/O Mode: DI or Event Counter

Dry Contact:

- On: short to GND
- Off: open

Wet Contact (DI to COM):

- On: 10 to 30 VDC
- Off: 0 to 3 VDC

Common Type: 6 points per COM

Counter Frequency: 2.5 kHz, power off storage

Digital Filtering Time Interval: Software selectable

Relay Output

Type: Form A (N.O.) power relay

Contact Current Rating:

- Resistive Load: 5 A @ 30 VDC, 250 VAC, 110 VAC

Breakdown Voltage: 500 VAC

Relay On/Off Time: 1500 ms (Max.)

Initial Insulation Resistance: 1000 M ohms (min.) @ 500 VDC

Mechanical Endurance: 5,000,000 operations

Electrical Endurance: 100,000 operations @ 5 A resistive load

Contact Resistance: 100 m ohms (max.)

Pulse Output: 0.3 Hz at rated load

Note: Ambient humidity must be non-condensing and remain between 5 and 95%. The relays of the ioLogik R1214 may malfunction when operating in high condensation environments below 0°C.

Power Requirements

Power Input: 24 VDC nominal, 12 to 48 VDC

Power Consumption: 207 mA @ 24VDC

ioLogik R1240

Inputs and Outputs

Analog Inputs: 8 channels

Isolation: 3K VDC or 2K Vrms

Analog Input

Type: Differential input

Resolution: 16 bits

I/O Mode: Voltage / Current

Input Range: 0 to 10 VDC, 0 to 20 mA, 4 to 20 mA (burn-out mode)

Accuracy:

±0.1% FSR @ 25°C

±0.3% FSR @ -10 and 60°C

±0.5% FSR @ -40 and 75°C

Sampling Rate (all channels):

12 Hz

Input Impedance: 10M ohms (min.)

Built-in Resistor for Current Input: 120 ohms

Power Requirements

Power Input: 24 VDC nominal, 12 to 48 VDC

Power Consumption: 216 mA @ 24VDC

ioLogik R1241

Inputs and Outputs

Analog Outputs: 4 channels

Isolation: 3K VDC or 2K Vrms

Analog Output

Resolution: 12 bits

Output Range: 0 to 10 VDC, 4 to 20 mA

Voltage Output: 10 mA (max.)

Accuracy:

±0.1% FSR @ 25°C

±0.3% FSR @ -40 and 75°C

Load Resistor:

- Internal power: 400 ohms
- External 24V power: 1000 ohms

Power Requirements

Power Input: 24 VDC nominal, 12 to 48 VDC

Power Consumption: 343 mA @ 24VDC

Physical Dimensions

The dimensions of the ioLogik R1200 product are 27.8 x 124 x 84 mm. The connector for the two RS-485 ports is a 5-pin 3.81 terminal block (2 RS-485 ports with 1 ground pin). The power connector is on the top and the reset button is on the bottom of the product. There are also two dials for Board ID setup, and a 2-pin DIP switch for "Initial/Run" mode and "Dual RS-485/Repeater" mode setup.

Unit: mm (inch)

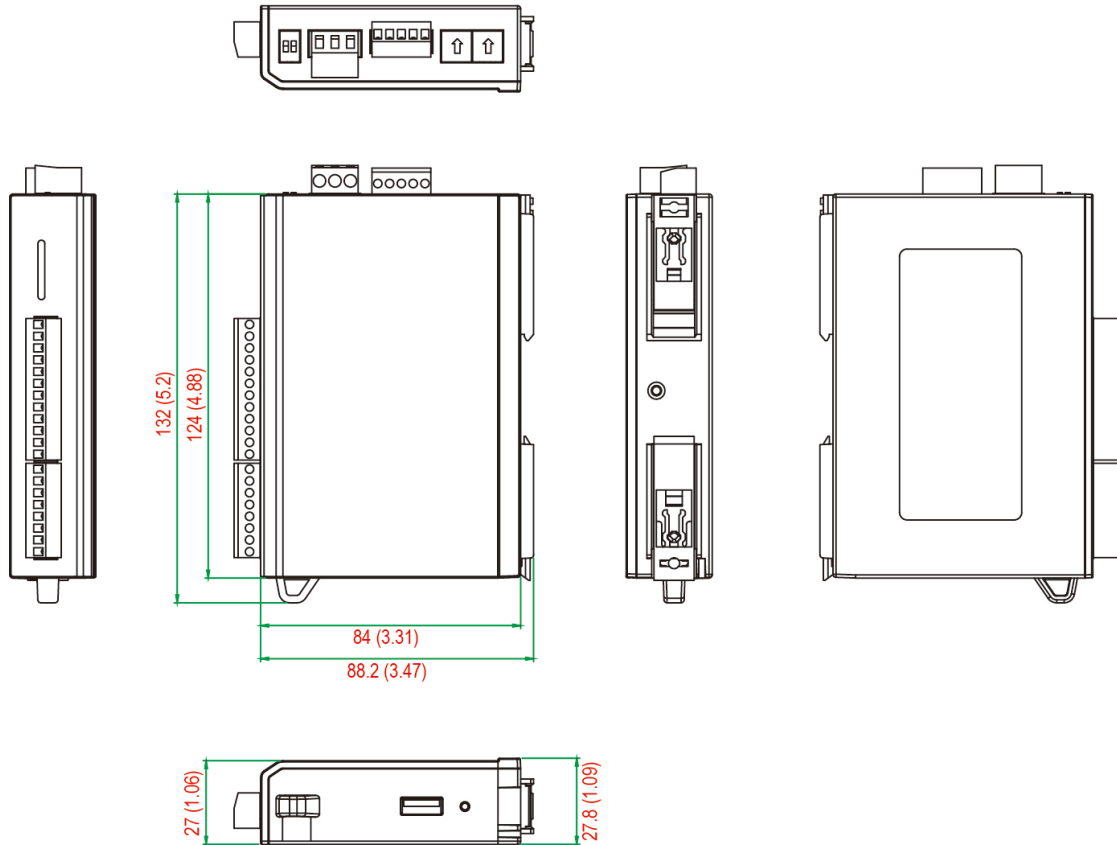

Hardware Reference

Panel Guide

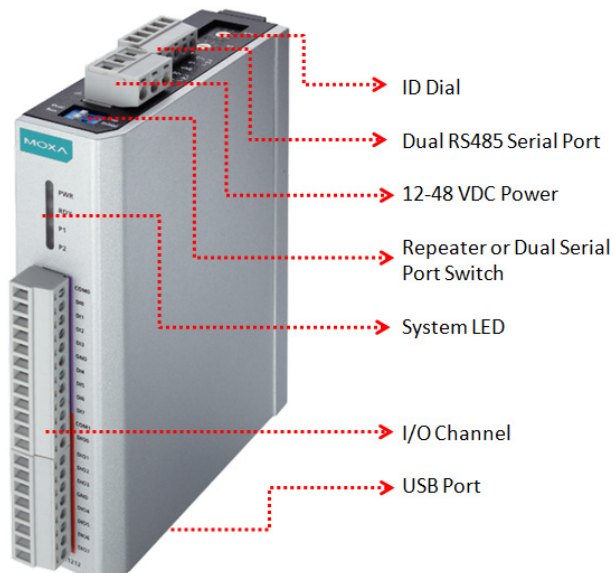

NOTE The RESET button restarts the server and resets all settings to factory defaults. Use a pointed object such as a straightened paper clip to hold down the reset button for 5 seconds. The factory defaults will load once the READY LED turns green again. You may then release the RESET button.

LED Indicators

LED	State	Description
Power (PWR)	Amber	System power is ON
	OFF	System power is OFF
Read (RDY)	Green	System is ready
	Flashing	Flashes every 1 sec when the Locate function is triggered
	Flashing	Flashes every 0.5 sec when the firmware is being upgraded
	Flashing	Flashing USB upgrade is triggered
	OFF	System is not ready.
Port 1 (P1)	Green	Serial connection enabled
	Flashing	Transmitting or receiving data
Port 2 (P2)	Green	Serial connection enabled
	Flashing	Transmitting or receiving data

Switch Settings

The R1200 series provides Dual/Rep and Run/Initial switch settings for setting the communication mode.

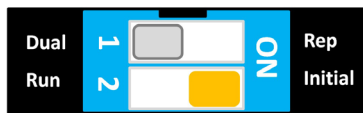

- Dual (Default) Dual RS-485 mode
- Rep Repeater mode
- Run User defined communication parameters
- Initial (Default) Initial RS-485 communication parameters

DI Circuit Diagram

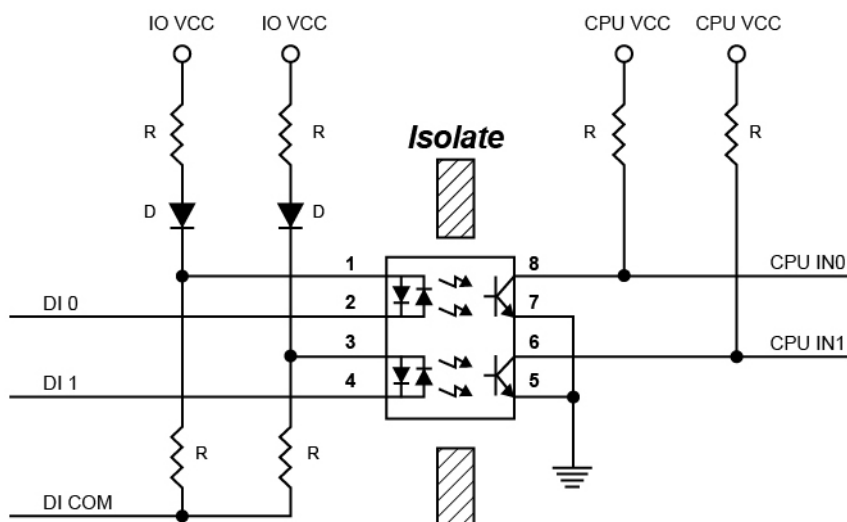

DIO Circuit Diagram

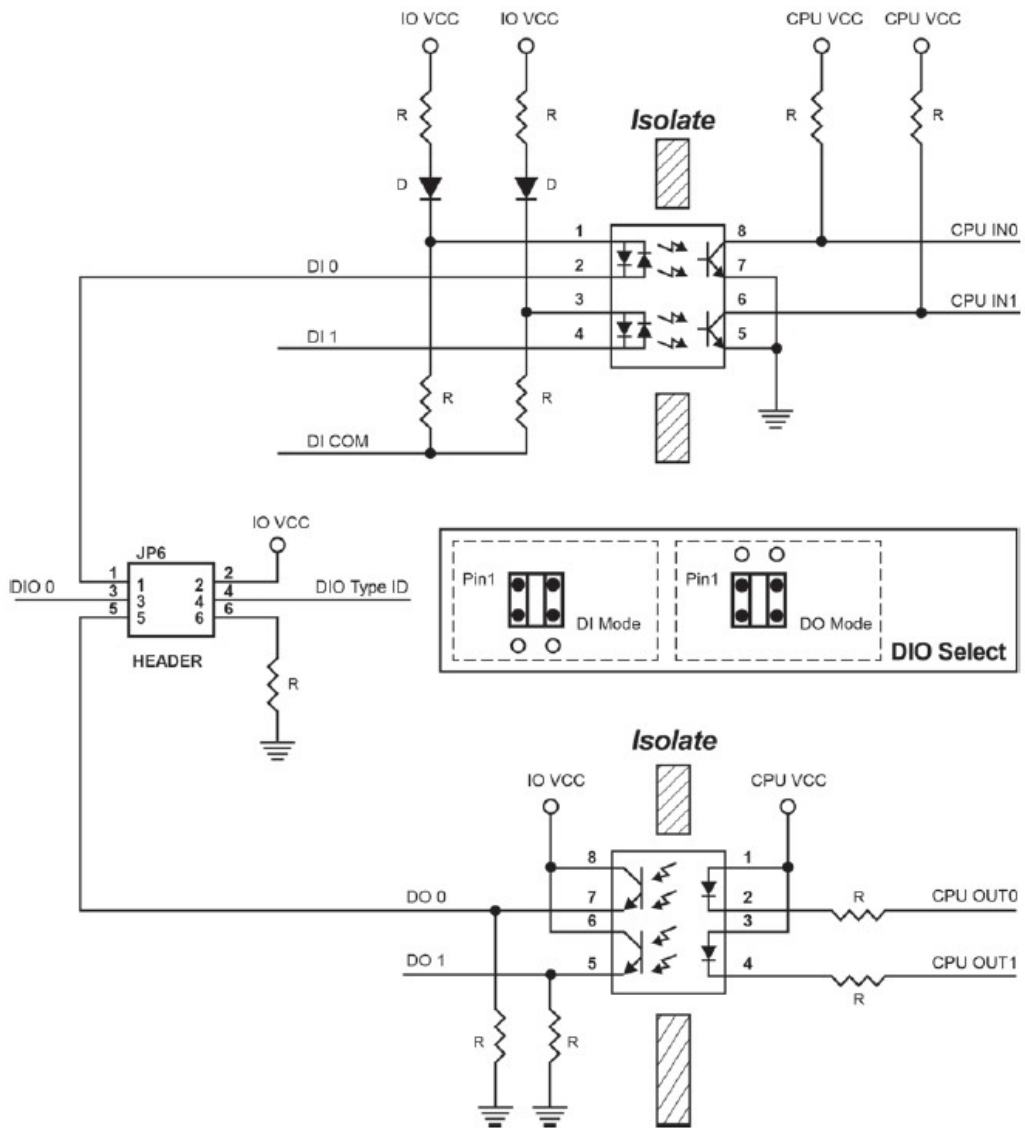

Relay Circuit Diagram

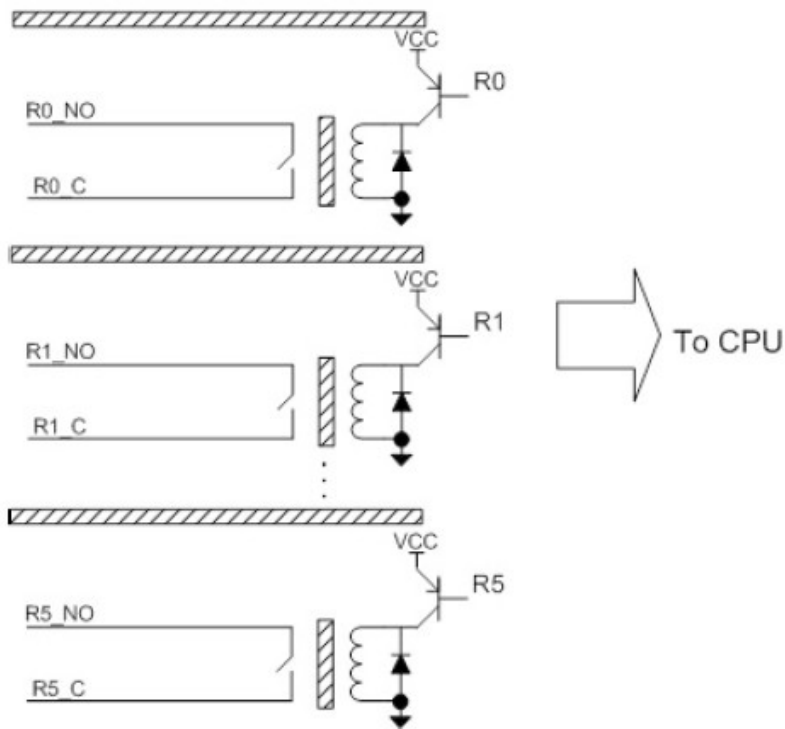

AI Circuit Diagram

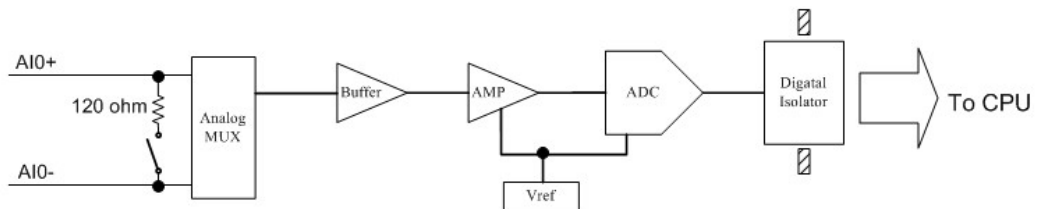

The following topics are covered in this chapter:

□ **Hardware Installation**

- Connecting the Power
- Grounding the ioLogik R1200
- Connecting to Serial Interface
- Mounting the ioLogik R1200
- Connecting to Digital Sensors and Devices
- RS-485 Networks
- Modbus/RTU Devices
- Dual RS-485 or Repeater Settings
- Jumper Settings (DIO and AI)
- Pull High/Low DIP Switch Settings for the RS-485 Port

□ **Software Installation**

- ioSearch Installation
- Initial Setup by USB
- Restore Factory Default Settings

Hardware Installation

Connecting the Power

Connect the 12 to 48 VDC power line to the ioLogik R1200's terminal block on the top panel. If power is properly supplied, the Power LED will glow a solid amber color.

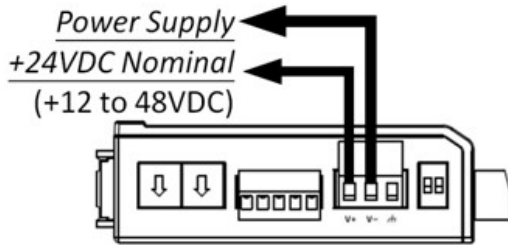

ATTENTION

Determine the maximum possible current for each power wire and common wire. Observe all electrical codes dictating the maximum current allowable for each wire size. If the current exceeds the maximum rating, the wiring could overheat, causing serious damage to your equipment. For safety reasons, we recommend an average cable size of 22 AWG. However, depending on the current load, you may want to adjust your cable size (the maximum wire size for power connectors is 2 mm).

Grounding the ioLogik R1200

The ioLogik R1200 is equipped with a grounding point on the terminal block located on the top panel. Connect the ground pin if an earth ground is available.



Connecting to Serial Interface

TB1 and TB2 (two RS-485 2-wire connectors)

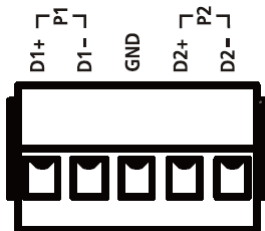

	TB1 (RS-485)			TB2 (RS-485)		
Pin	1	2	3	4	5	3
Signal	D1+	D1-	GND	D2+	D2-	GND

NOTE TB1 and TB2 share the same ground.

Mounting the ioLogik R1200

The ioLogik R1200 can be used with both DIN rail and wall mounting applications.

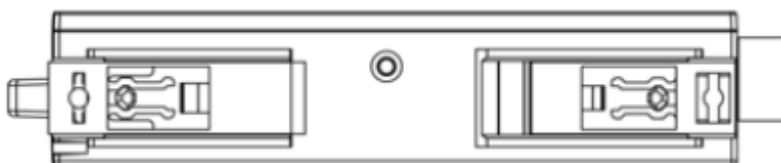

Connecting to Digital Sensors and Devices

Digital Input/Output (Sink Type)

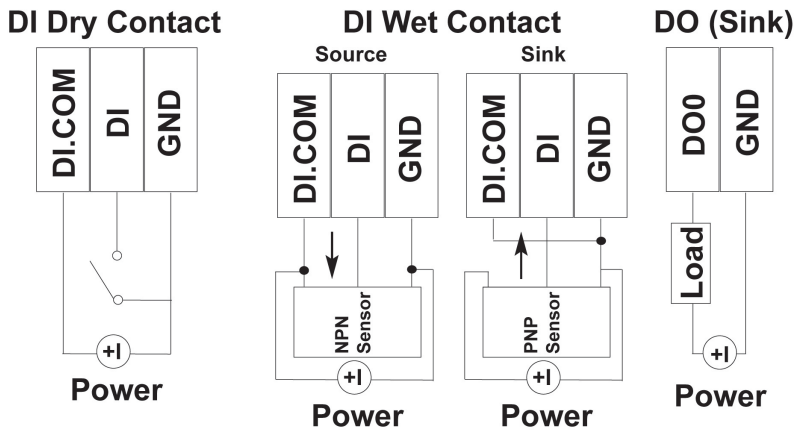

A **Dry Contact** is a contact that works without a power source.

A **Wet Contact** is a contact that must work with a power source.

Analog Input/Output

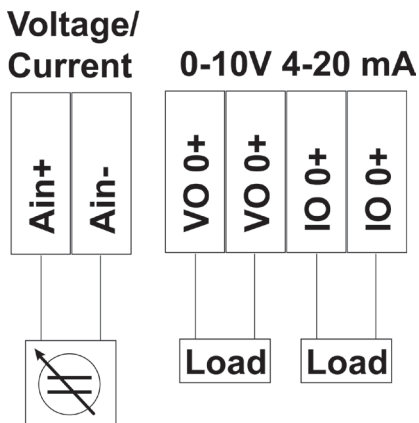

Relay Output (Form A)

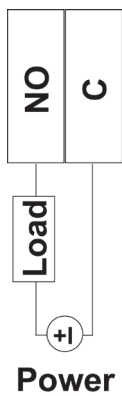

NOTE A "load" in a circuit schematic is a component or portion of the circuit that consumes electric power. For the diagrams shown in this document, "load" refers to the devices or systems connected to the remote I/O unit.

RS-485 Networks

RS-485 permits a balanced transmission line to be shared in a party line or multi-drop configuration. As many as 32 driver/receiver pairs can share a multi-drop connection on a single two-wire bus. The length of the network is limited to 4,000 ft between the first node and the last node. You can use RS-485 in two-wire or four-wire multi-drop network applications.

In an RS-485 four-wire network, one node must be a master node and all others slave nodes. The master does not require tri-state output.

NOTE The transmission line is terminated on both ends of the line but not at drop points in the middle of the line. Termination is only required with high data rates or long wire runs.

Setting the Device ID for RS-485 Serial Communication

The RS-485 port is used to communicate with other RS-485 devices or to link to another ioLogik RS-485 I/O server. The RS-485 port can run Modbus/RTU or I/O command sets. The device ID for each ioLogik R1200 device can be set to any number from 01 to 99 by turning the two rotary dials on the back of the device. The x1 dial (shown on the left in the figure below) represents the ones place and the x10 dial (shown on the right in the figure below) represents the tens place. Settings such as the baud rate, parity check, data bits, and stop bit are configured by software.

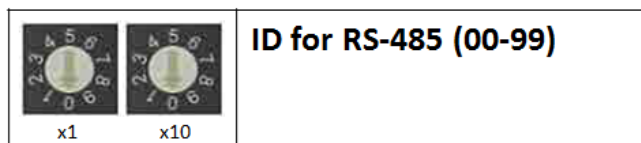

Serial Communication Parameters (Initial State)

Communication Parameters (Initial mode)

Parity	None, Even, Odd (default = None)
Data Bits	8
Stop Bits	1, 2 (default = 1)
Baudrate	1200 to 921.6 kbps (default = 9600)

Serial Communication Initial Setup

During your initial setup, set the switch to "Initial" mode to configure your device, after configuration is done flip the switch back to "Run" mode.



NOTE The initial communication setting is: baudrate = 9600, n, 8, 1.

Modbus/RTU Devices

The RS-485 port runs Modbus/RTU and can connect to any Modbus device. You may use different methods to connect different combinations of ioLogik R1200 servers and other Modbus devices. Some examples are shown below:

Connecting One Modbus/RTU Device

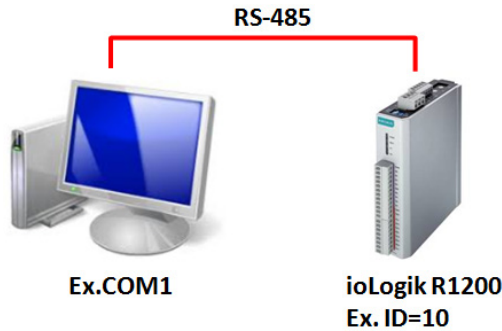

Connecting Multiple Modbus/RTU Devices

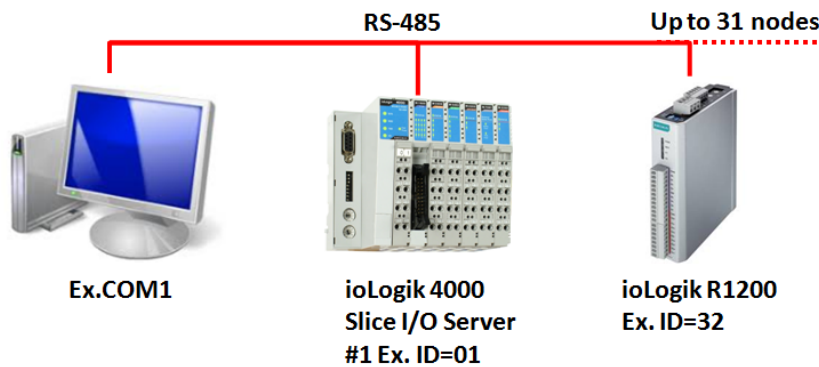

Dual RS-485 or Repeater Settings

Dual RS-485: Switching the dial to "Dual" will divide the RS-485 port into two separate RS-485 ports for users to run dual RS-485 lines.



Repeater: Switching the dial to "Rep" will set the ioLogik R1200 to act as a repeater.

NOTE In Repeater mode, when signals pass through one machine, the latency will increase by 1 byte with a maximum of 10 ms at 1200 bps baudrate.



Jumper Settings (DIO and AI)

The models with DIO or AI channels require configuring the jumpers inside the cover. Remove the screw located on the back panel and open the cover to configure the jumpers.

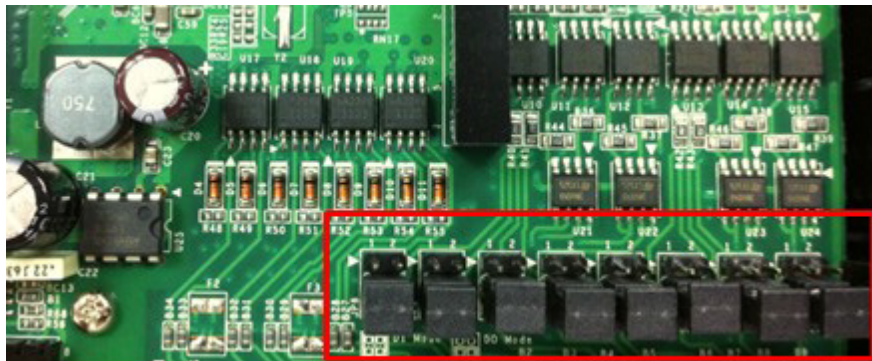

DIO mode configuration is shown to the right (default: DO Mode).

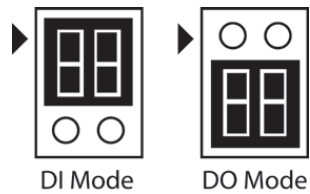

Analog mode configuration is shown to the right (default: Voltage Mode).

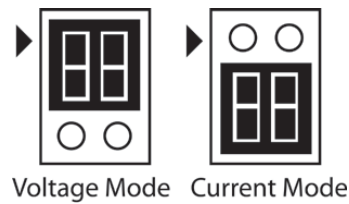

ATTENTION

Remove the screw on the back panel and open the cover to configure the jumpers.

Pull High/Low DIP Switch Settings for the RS-485 Port

In some critical environments, you may need to add termination resistors to prevent the reflection of serial signals. When using termination resistors, it is important to set the pull high/low resistors correctly so that the electrical signal is not corrupted. Since there is no resistor value that works for every environment, DIP switches are used to set the pull high/low resistor valve for each RS-485 port.

DIP switches inside the cover of the ioLogik R1200 are used to set the pull high/low resistor values for each serial port.

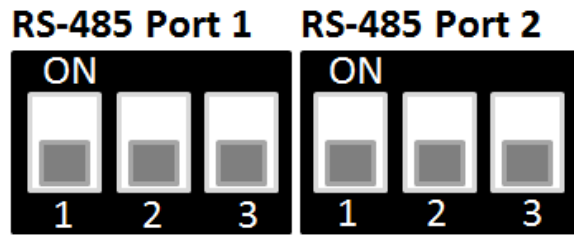

*Default setting (high/low resistors to 150 KΩ)

To set the pull high/low resistors to 150 kΩ, make sure both of the assigned DIP switches are in the OFF position (default setting).

To set the pull high/low resistors to 1 kΩ, make sure both of the assigned DIP switches are in the ON position.

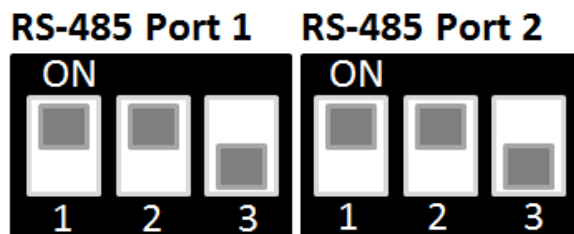

* high/low resistors to 1 KΩ

Pull High/Low DIP switch settings for the RS-485 Port

Switch	1	2	3
		Pull High/Low	Pull High/Low
ON	1 kΩ	1 kΩ	120 Ω
OFF (default)	150 kΩ	150 kΩ	----

Software Installation

ioSearch Installation

ioSearch™ is a search utility that helps the user locate ioLogik R1200 devices on the local RS-485 network. The latest version can be downloaded from Moxa's website.

- 1. Install from the website:** To download the software from Moxa's website, first click on the following link to access the website's search utility: <http://www.moxa.com/support/search.aspx?type=soft>. When the webpage opens, enter the model name of your product in the search box. Click the model name and navigate to the product page, and then click on ioSearch, located in the box titled Software. Download and then unzip the file, and then run SETUP.EXE from that location. The installation program will guide you through the installation process and install the software. You can also install the MXIO DLL library separately.
- 2. Open ioSearch:** After installation is complete, run ioSearch from **Start → Program Files → MOXA → IO Server → Utility → ioSearch**
- 3. Search for the server:** On the menu bar, select **System → Auto Search Remote I/O Server**. In the dialog window, select "RS-232/485 I/O server" and click "Start Search."

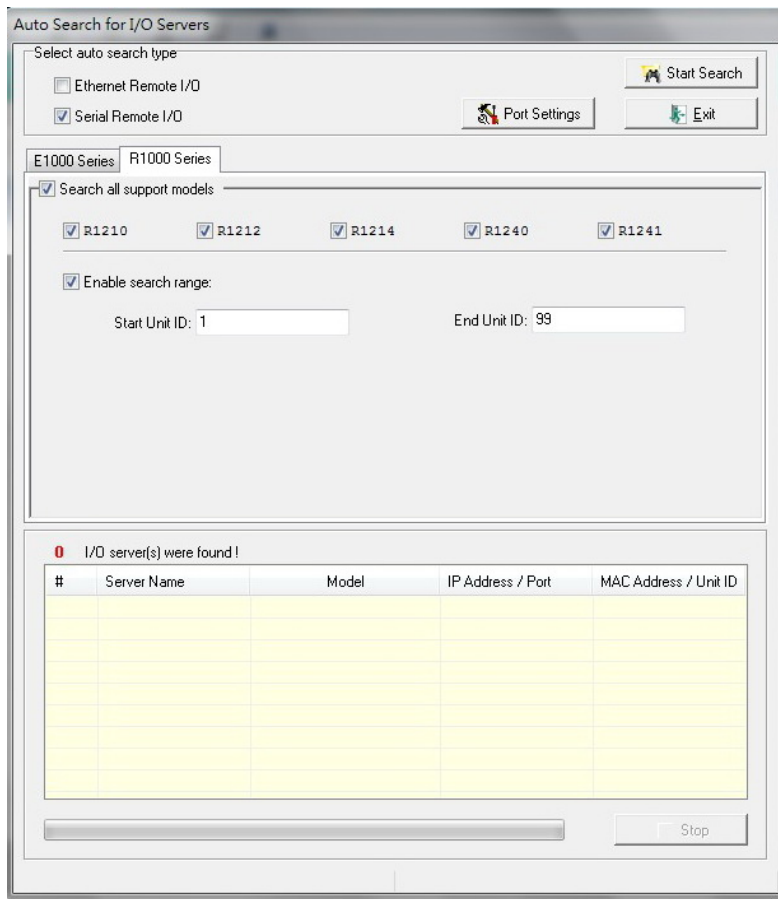

- If multiple ioLogik R1200 units are installed on the same network, remember to assign a unique device ID to each unit to avoid conflicts.
 - If ioSearch is unable to find the ioLogik R1200 device, there may also be a problem with your COM port settings. Click "Port Settings" to view or modify the settings.
4. **Monitor I/O status:** Once the unit is found by ioSearch, you can view the status of all connected I/O devices on the ioSearch main screen.

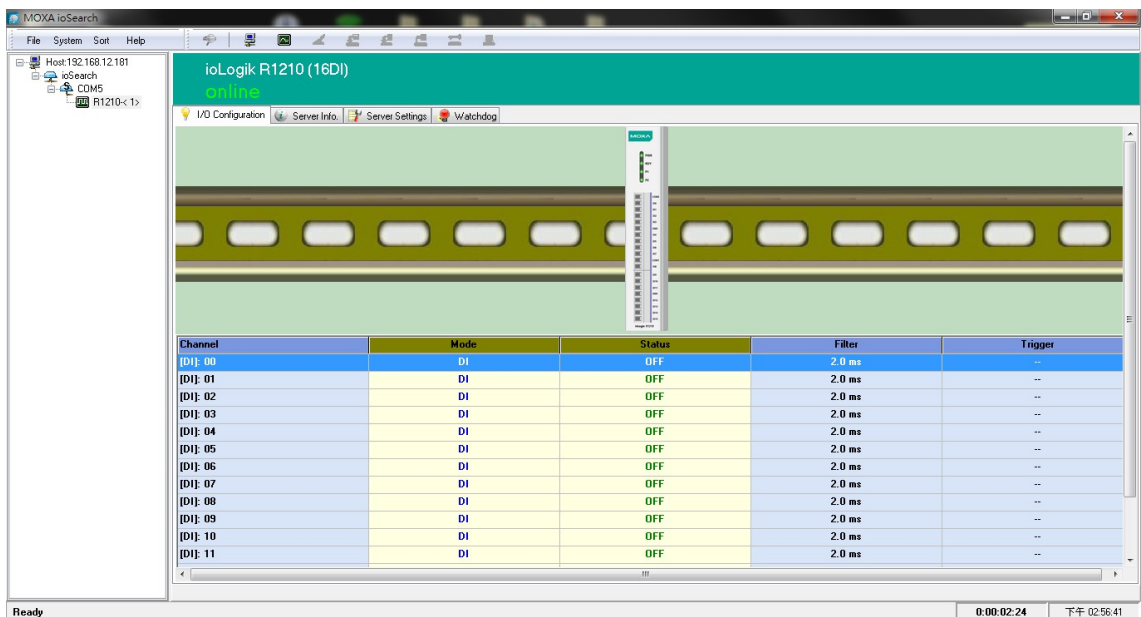

Initial Setup by USB

When setting up your ioLogik R1200 for the first time, you need to import the initial configuration and firmware files onto a USB drive. But before you connect the USB drive to the ioLogik R1200's USB port to install and upgrade configurations and firmware, you first need to place the configuration files under a designated folder.

NOTE The USB format should be FAT or FAT32. The NTFS format is not supported.

Import Configuration File

To import configuration files via USB, follow these steps:

1. Create a new "config" folder on the USB drive
2. Use the ioSearch utility to export the configuration file from the device and place the file into the "config" folder created in step 1 (above):
X : \config\R12YY.txt
(X represents the USB drive, and R12YY represents the model type)

Upgrade Firmware

To upgrade the firmware by USB, follow these steps:

1. Create a new "fwr" folder on the USB drive.
2. Place the firmware file under the folder created in step 1:
X : \fwr\R12YY.1kp
(X represents the USB drive, and R12YY represent the model type)

Configure the Device

After you set up the USB drive, follow the steps below to configure your ioLogik R1200 device.

1. Power off the ioLogik R1200.
2. Set the DIP switch to "Initial" mode.



3. Plug the USB drive into the ioLogik R1200 device.
4. Power on the ioLogik R1200 and the USB drive will automatically install the system files.
(Process: Rdy LED Red blinking 3s, then Green blinking,
Result: RdyLED Green: pass, Rdy Red: Failed)

5. Power off the ioLogik R1200 device.
6. Unplug the USB drive.
7. Set the DIP switch to "Run" mode.



Restore Factory Default Settings

There are two ways to restore the ioLogik R1200 device to the factory default settings.

1. Hold the reset button for 5 seconds.
2. Right-click on the ioLogik unit you want to restore in the ioSearch utility and change "Reset" to "Default."

The following topics are covered in this chapter:

- **Introduction to ioSearch**
- **ioSearch Main Screen**
- **Main Screen Overview**
- **ioSearch Setup**
 - System
 - Sort
 - Help
- **Quick Links**
- **Main Functions**
 - Locate
 - Connect/Disconnect
 - Firmware Upgrade
 - Import
 - Export
 - Change Server Name
 - Restart System
 - Delete ioLogik Device
 - Reset to Default
- **Main Screen**
 - I/O Configuration Tab (General)
 - Configuring Digital Input Channels
 - Configuring Digital Output Channels
 - Configuring Analog Input Channels
 - AI Input Range
 - Configuring Analog Output Channels
- **Server Info Tab**
 - Server Settings Tab (General)
 - Watchdog

Introduction to ioSearch

The ioSearch utility is used for locating or searching for an Logik R1200 unit on the physical network. The following functions are supported by the ioSearch utility.

- Search for and locate ioLogik R1200 units
- Configure communication address
- Upgrade firmware for multiple ioLogik R1200 units
- Export configuration files from multiple ioLogik R1200 units
- Import a configuration file to multiple ioLogik R1200 units
- Reset to default

ioSearch Main Screen

The main screen of the ioSearch utility defaults to the I/O Configuration tab, which displays an image of the ioLogik R1200 and the status of each I/O channel. The other tabs on the main screen take you to server and network settings, and additional functions are available when you log on as an administrator. Note that configuration options are not available until you log on as an administrator.

Main Screen Overview

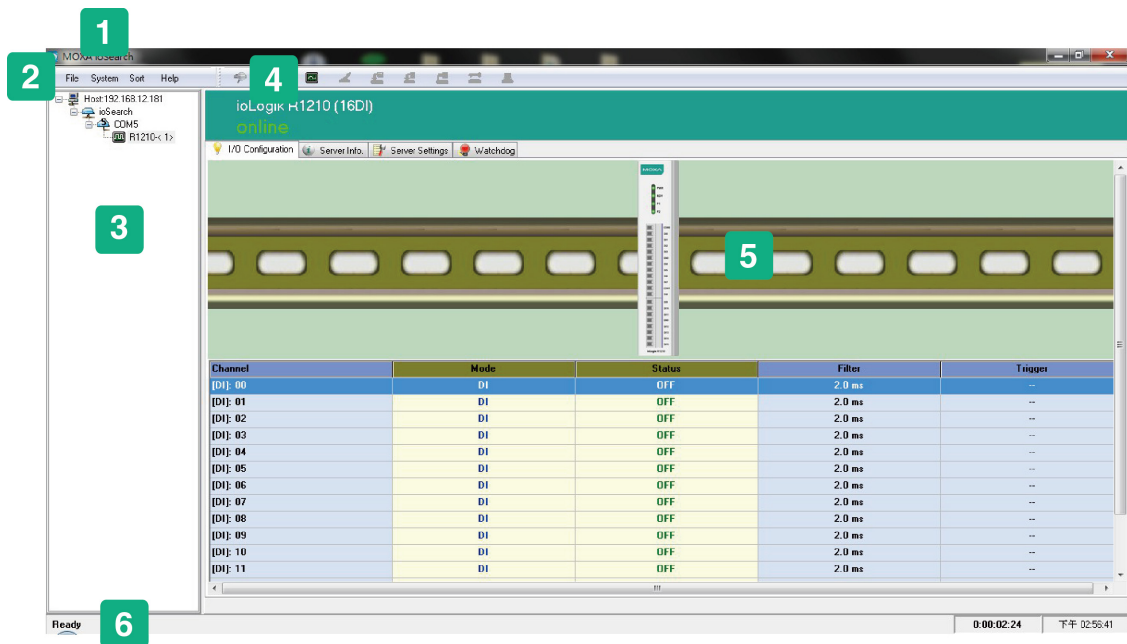

ioSearch Main Screen	
1	Title
2	Menu bar
3	Navigation panel
4	Quick link
5	Main window
6	Status Bar

ioSearch Setup

System

Several functions are available from the **System** menu.

Auto Search Remote Ethernet I/O Servers will search for ioLogik servers on the network. When connecting for the first time or recovering from a network disconnection, you can use this command to find I/O servers that are on the network.

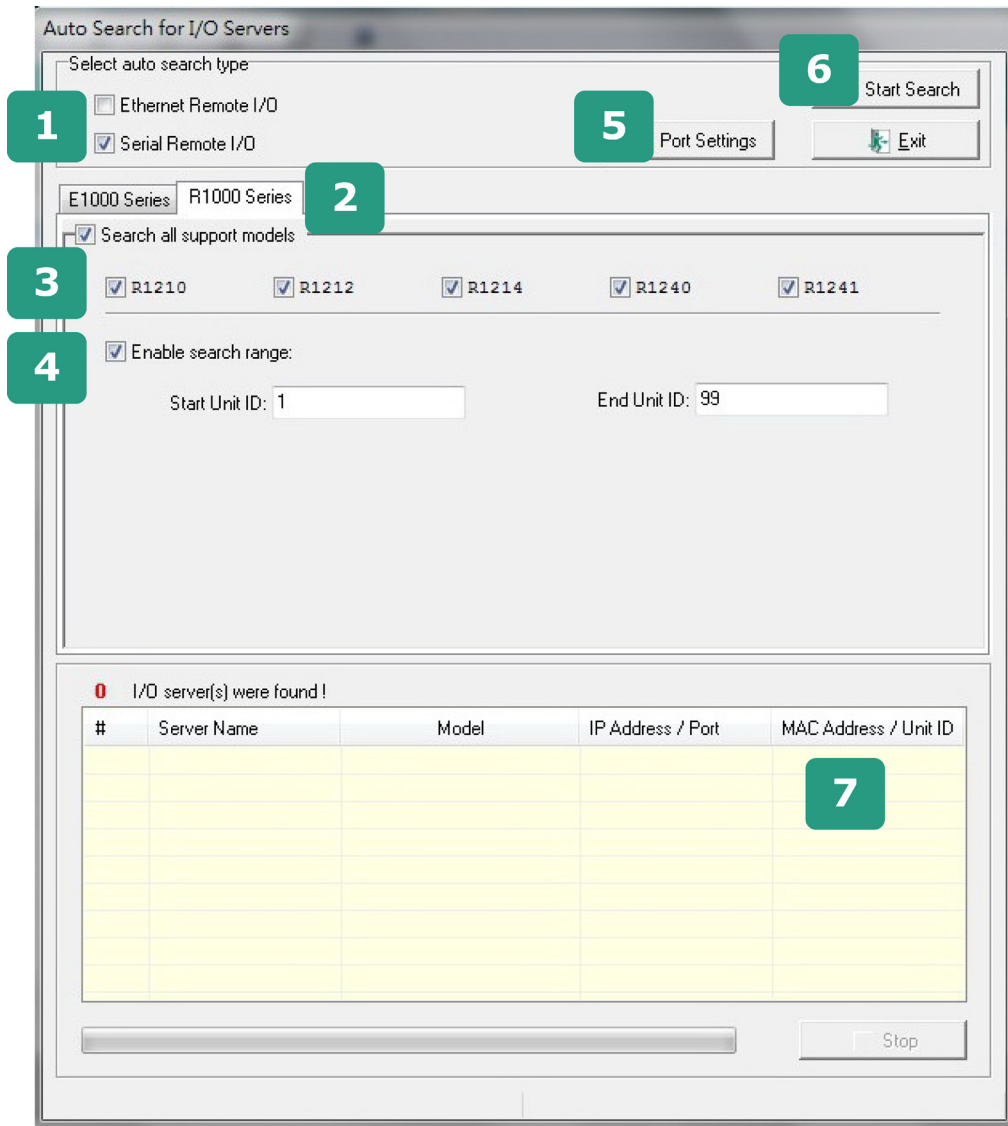

Steps to Search for an ioLogik R1200 device:

1. Select the "RS-232/485 Remote I/O" checkbox.
2. Select the "R1000 Series" tab.
3. Select the ioLogik R1200 model(s) for which you are searching.
4. Click and Select "Enable search range" and enter the unit ID number, which ranges from 1 to 99.
5. Click the **Port Settings** button to configure, set, or verify the serial port settings. Select specific COM ports under "Only Search", or select "Search All System Com Ports" to configure COM port settings, the Modbus protocol, and timeout interval.

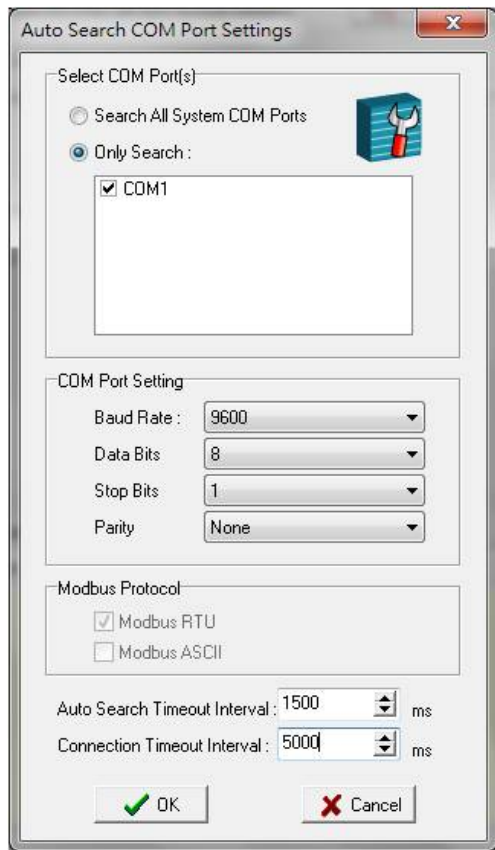

Auto Search Timeout Interval: The timeout interval sets the preferred waiting time for an ioLogik R1200 device to respond to a search. After exceeding the preset time limit, ioSearch will proceed to the next device on the network.

Connection Timeout Interval: The timeout interval sets the preferred waiting time for an ioLogik R1200 device to respond before it disconnects. After exceeding the preset time limit, ioSearch will disconnect the ioLogik R1200 device.

- When you click **Start Search**, ioSearch will begin searching up to 99 IDs for your ioLogik unit. The timeout interval is for RS-485 communication and defaults to 2,000 ms. As soon as your screen looks like the figure below, click **Stop**. Otherwise, ioSearch will continue to search all 99 ports.

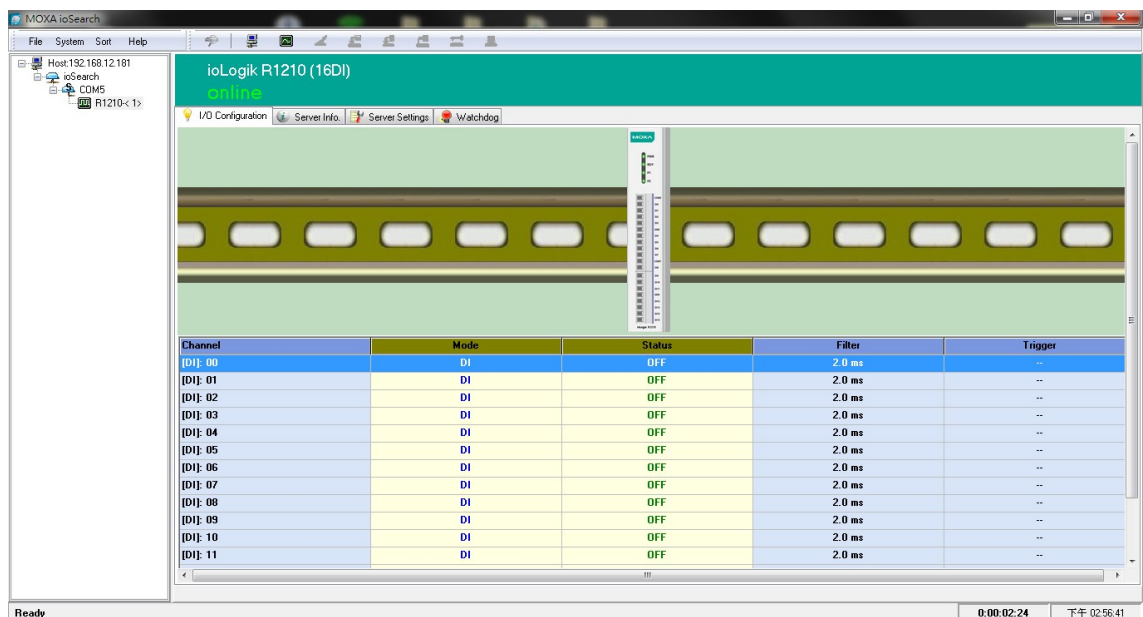

Once the ioLogik R1200 device has been discovered by the ioSearch utility, you will be able to monitor the I/O status from the first tab of the ioSearch utility. You will also be able to configure each DI and DO channel from this tab after first logging in under the **Management** tab.



ATTENTION

If ioSearch is unable to find your ioLogik R1200 device, confirm that the device ID matches the correct ioLogik device. See the previous section for setting or viewing the device ID.

Auto Search Timeout allows users to set the timeout value for TCP socket communication, but only for Ethernet remote I/O devices.

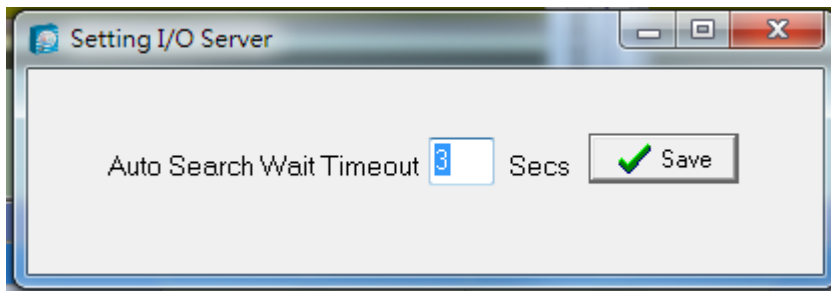

I/O Status Refresh Rate is used to adjust how often the I/O server is polled for device status. The current rate is displayed on the status bar at the bottom of the window. Note that higher sync rates result in higher loads on the network.

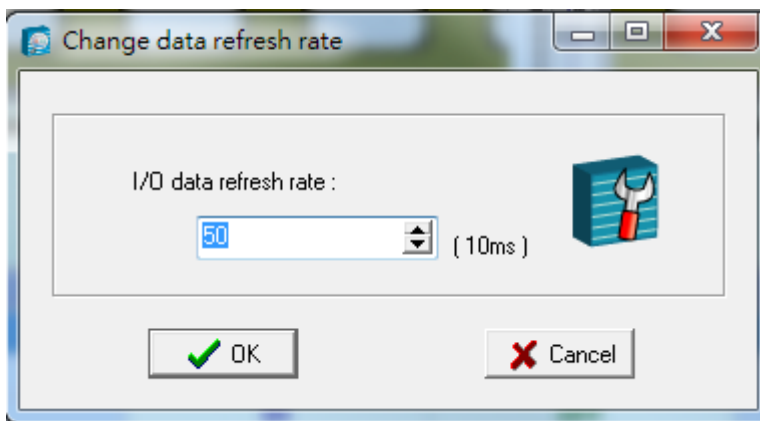

Sort

The **Sort** menu allows the server list in the navigation panel to be sorted by ioLogik connection and server model.

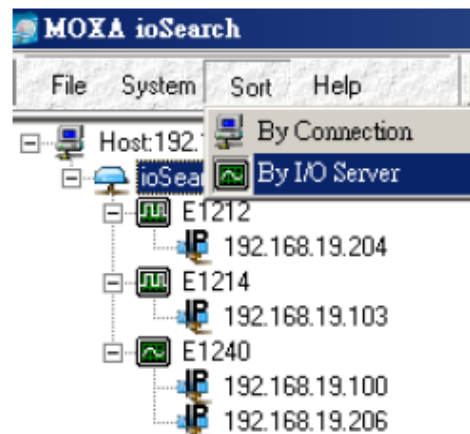
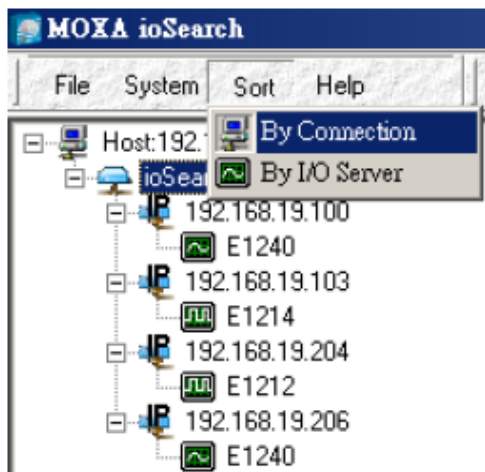

Help

In the **Help** menu, you can view vendor and version information.

Quick Links

Quick links are provided to search for I/O servers on the RS-485 network and sort the server list.



1. Automatically searches the local network
2. Sorts by ioLogik R1200 device ID ("By Connection")
3. Sorts by ioLogik R1200 model number ("By I/O Server")

Main Functions

Right click on a particular ioLogik R1200 device to view the ioSearch function menu.

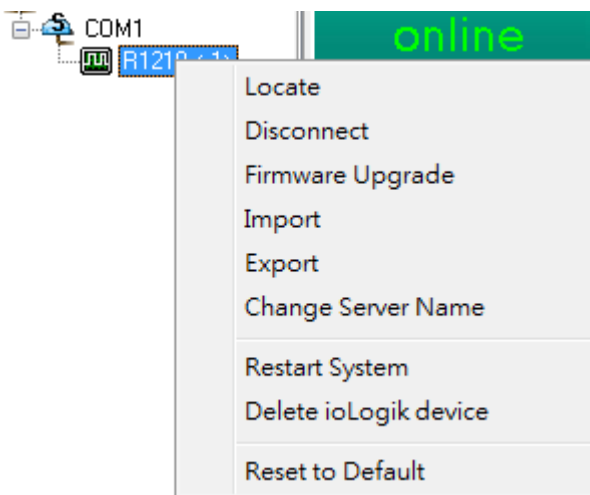

Locate

The locate function helps users find a specific ioLogik on the network. When this function is triggered, the ready LED on the selected unit will start to blink, indicating its location.



Connect/Disconnect

The Connect/Disconnect function connects or disconnects the ioLogik device from the ioSearch network.

Firmware Upgrade

The ioLogik R1200 supports a remote firmware upgrade function. Enter the path of the firmware file or click on the icon to browse for the file. The wizard will lead you through the process until the server restarts.

Import

Select this command to reload a configuration that was exported to a text file. You will need to restart the ioLogik in order for the new configuration to take effect. This command may be used to restore a configuration after loading the factory defaults, or to duplicate a configuration to multiple ioLogik units.

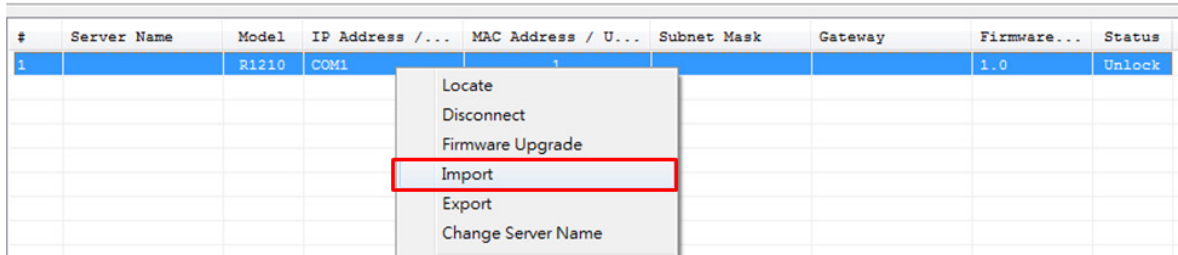

Export

Select this command to export the configuration of the ioLogik to a text file. You will need to log in as an administrator to use this function. It is strongly recommended you use this method to back up your configuration after you have finished configuring the ioLogik for your application.

Change Server Name

The Change Server name function can be used to directly modify the Server Name, especially for first time installation.

Changing the Server Name for multiple ioLogik R1200 devices is allowed. Select the ioLogik R1200 and then right click to process this function. After entering the desired server name, click Submit to apply changes.

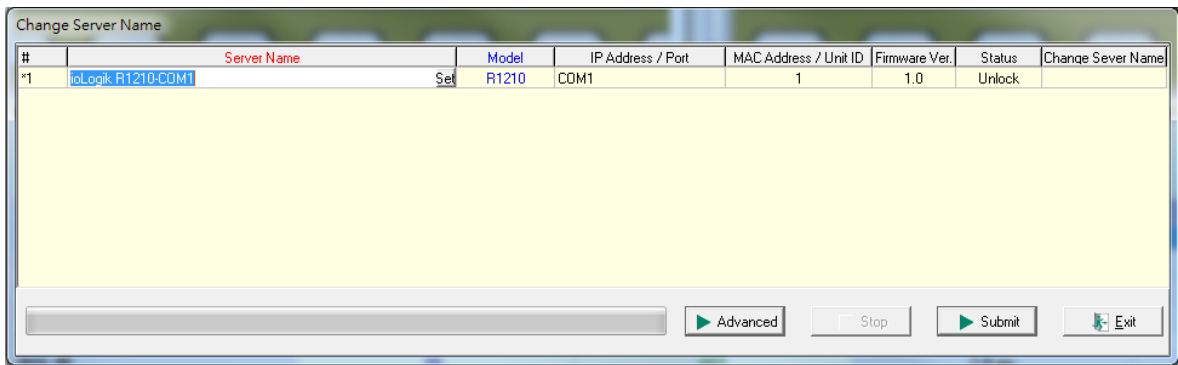

Restart System

Select this command to restart the selected ioLogik R1200 device.

Restart multiple ioLogik R1200 units by right-clicking on an ioLogik R1200 and selecting this function.

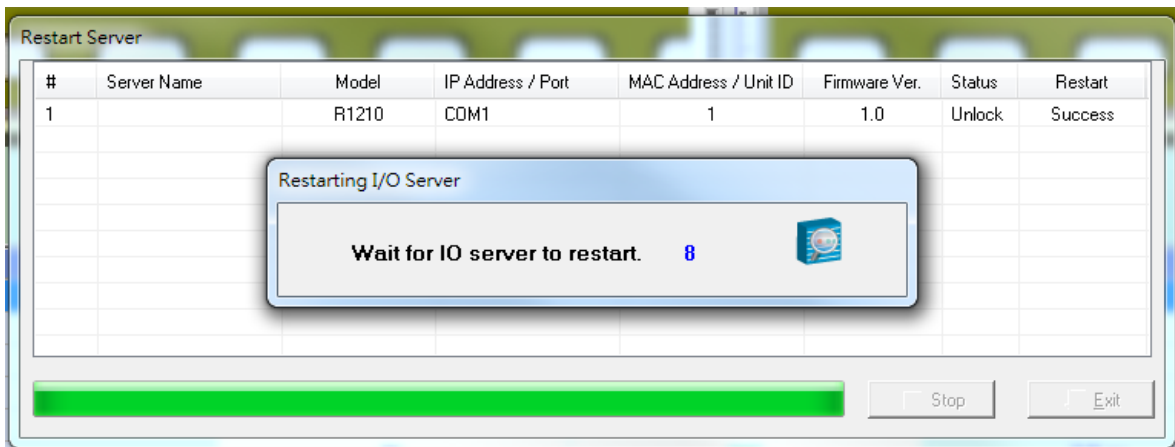

Delete ioLogik Device

Select this function to remove an ioLogik R1200 unit from the tree manually.

Reset to Default

Select this function to reset all settings, including console passwords, to factory default values.

Reset multiple ioLogik R1200 units to default configurations by right-clicking the ioLogik R1200 and selecting this function.

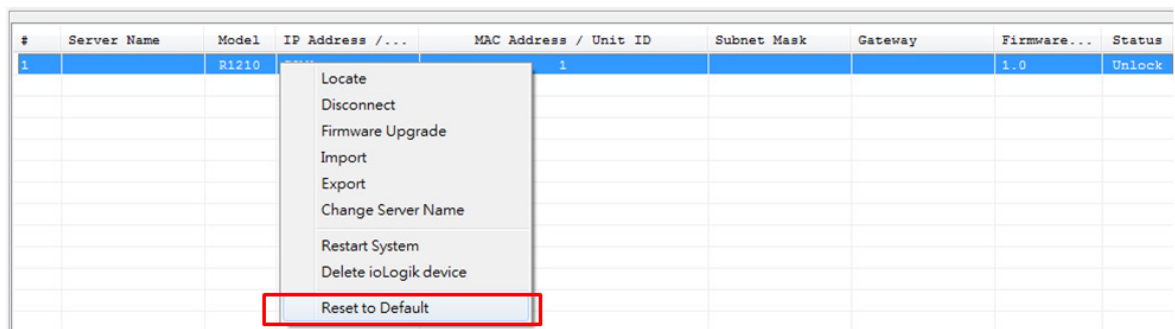

Main Screen

I/O Configuration Tab (General)

The **I/O Configuration** tab shows the status of every I/O channel. This is the default tab when you first open ioSearch.

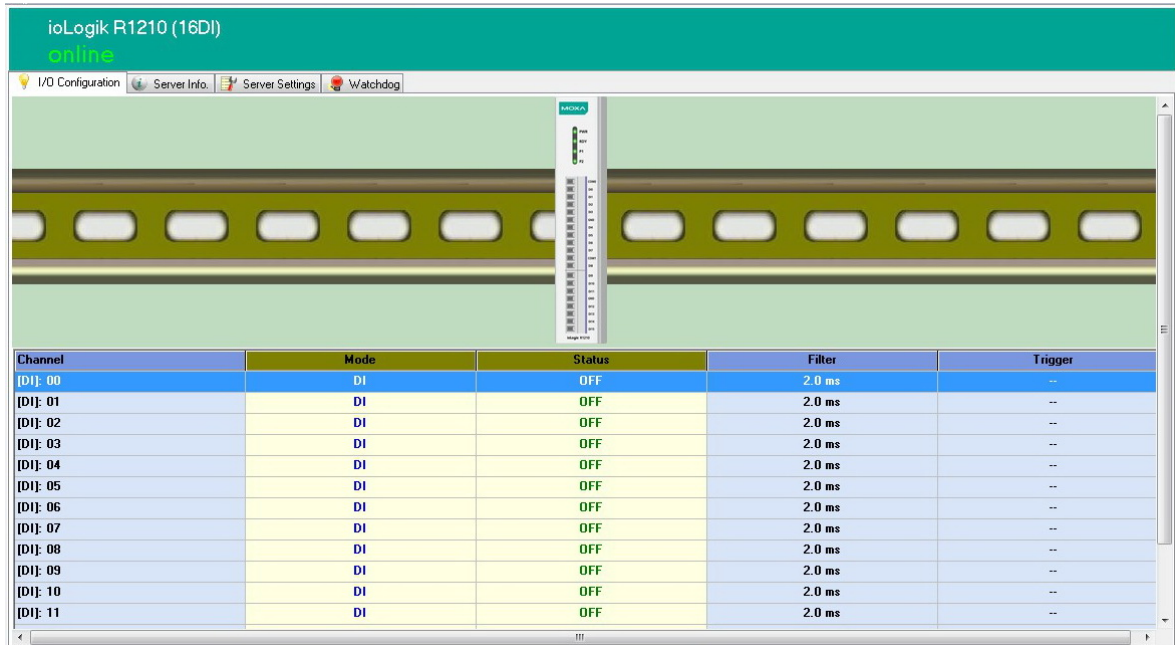

Configuring Digital Input Channels

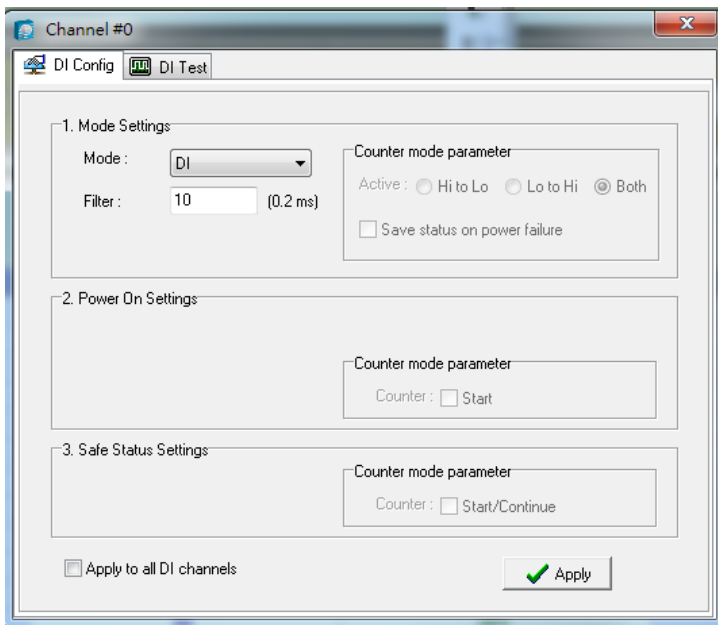

The ioLogik R1200’s digital channel can be separately set to “DI” or “Event Counter Mode.” In “DI” mode, the specifications are as follows:

Type	Logic 0 (OFF)	Logic 1 (ON)
Dry contact	Open	Close to GND
Wet contact (DI to COM)	0 to 3 V	10 to 30 V

In "Event Counter" mode, the ioLogik R1200's DI channel accepts data from limit or proximity switches, and counts events according to the ON/OFF status. You may select from two modes, "Lo to Hi" or "Hi to Lo." When "Lo to Hi" is selected, the counter value increases while the switch is pushed. When "Hi to Lo" is selected, the counter value increases when the switch is pushed and released. The sampling rate of the counter is 2.5 kHz. This function is designed for low speed switching, not for motor control.

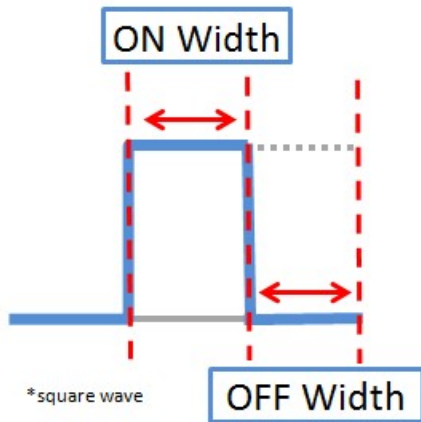

To eliminate the problem of switch bouncing, the ioLogik R1200 provides software filtering that is configurable in multiples of 0.2 ms. For example, a setting of 100 would mean a 20 ms filter (100 × 0.2 ms). The maximum value allowed by the software filter is 65535. Setting the filter to "0" causes the system to filter all signals.

Power On Settings: You may configure DI channels in Event Counter mode whether or not counting begins when powering up.

Safe Status Settings: For DI channels in Event Counter mode, you can configure whether or not counting starts or continues when Safe Status has been activated. When the network connection is lost as specified in the Host Connection Watchdog, the ioLogik R1200 will start or stop the counter according to the channel's Safe Status settings. Note that the Host Connection Watchdog is disabled by default, and must be enabled for Safe Status settings to take effect.

Test I/O: You can test DI channels in the **Test** tab to see how the status or counter value responds when the attached input device is manipulated.

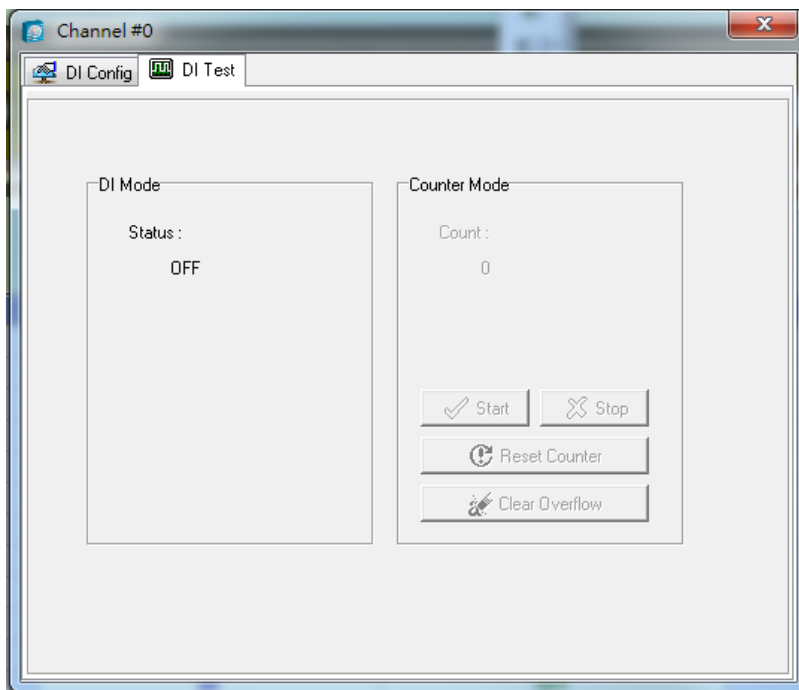

Configuring Digital Output Channels



Each ioLogik R1200 digital output channel can be set to “DO” or “Pulse Output” mode. In DO mode, the specifications are as follows.

Type	Logic 0 (OFF)	Logic 1 (ON)
DO mode	Open	Short

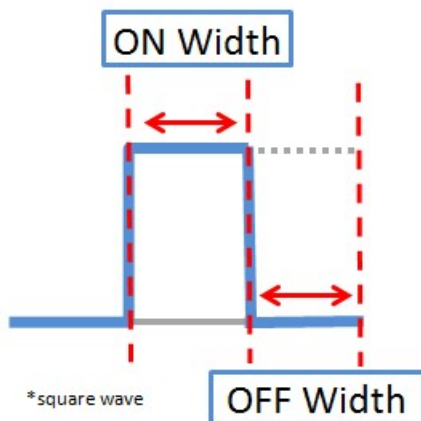

In “Pulse Output” mode, the selected digital output channel will generate a square wave as specified in the pulse mode parameters. The Low and High parameters are in multiples of 0.1 ms, with a maximum setting of 65535. To set the low level width for 5 ms, you would enter 50 (because $50 \times 0.1 \text{ ms} = 5 \text{ ms}$). A setting of **100** for both Low and High would generate a square wave with a 20 ms cycle. The **Output** parameter specifies the number of pulses to send. When set to **0**, the system will send pulses continuously.



Power On Settings: Use this field to set the initial status for the DO channel when the ioLogik is powered on.

Safe Status Settings: Use this field to specify how the DO channel responds to a break in network communication. When the network connection is lost as specified in the Host Connection Watchdog, the ioLogik R1200 will reset all channels according to their Safe Status settings. Note that the Host Connection Watchdog is disabled by default, and must be enabled for Safe Status settings to have effect.

Test I/O: You can test the DO channel in the **Test** tab.

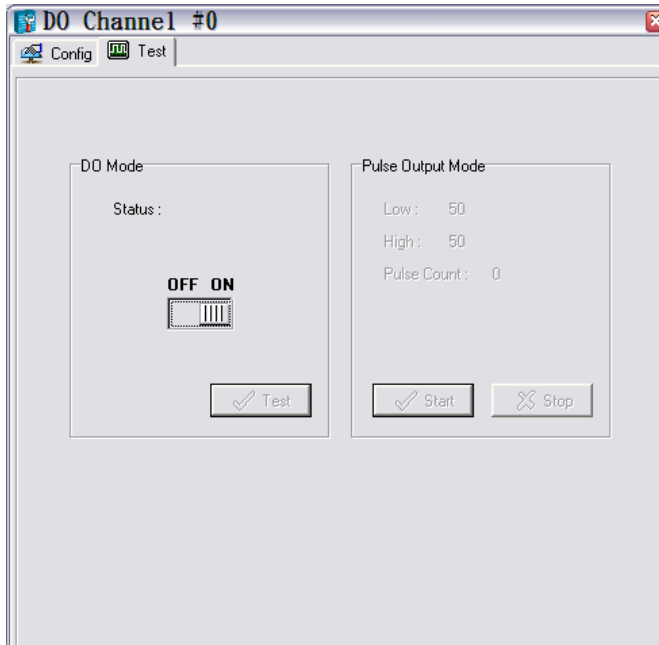

Configuring Analog Input Channels

The current status of each AI (analog input) channel can be viewed on the I/O Setting:

Click on a specific channel to enable or disable the AI channel by selecting the "Enable AI Channel" field.

There are two modes for the AI channels:

1. **AI Input: Voltage Mode (V)** (See Chapter 2, **Jumper Settings (DIO and AI)**, for more information)

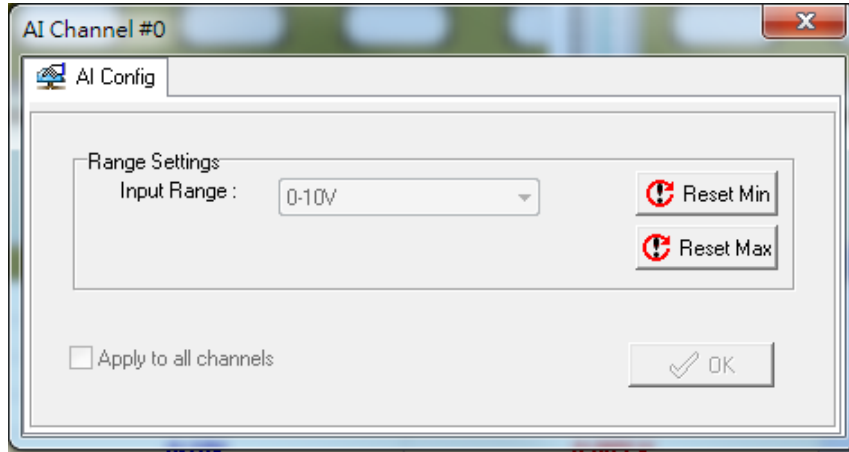

2. **AI Input: Current Mode (mA)** (See Chapter 2, **Jumper Settings (DIO and AI)**, for more information)

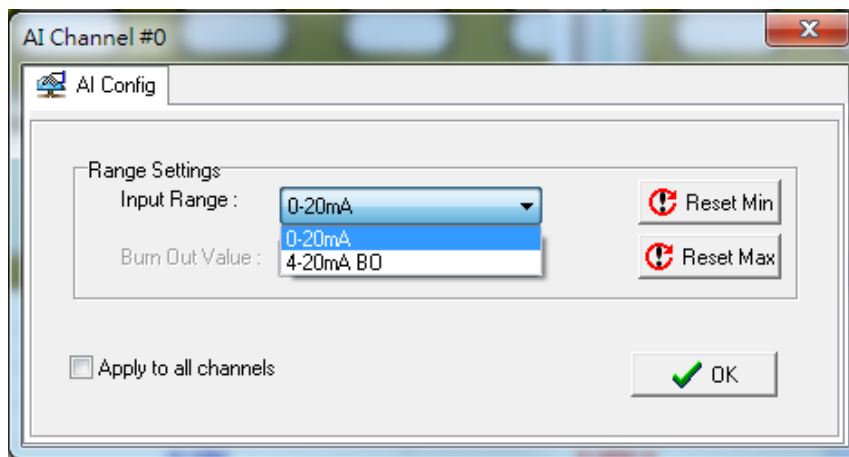

AI Input Range

Set the AI input ranges for each mode, as follows:

1. **AI Input: Voltage Mode (V)** (See **Jumper Settings (DIO and AI)** in Chapter 2 for more information)

There is only one default analog "voltage" input range: [0-10V]

2. **AI Input: Current Mode (mA)** (See **Jumper Settings (DIO and AI)** in Chapter 2 for more information)

There are two modes in the analog "current" input range: [0-20 mA], [4-20 mA (burnout)]

Burnout mode indicates if the current analog input has burned out. For example, the 4–20 mA burnout mode is defined in the following diagram:

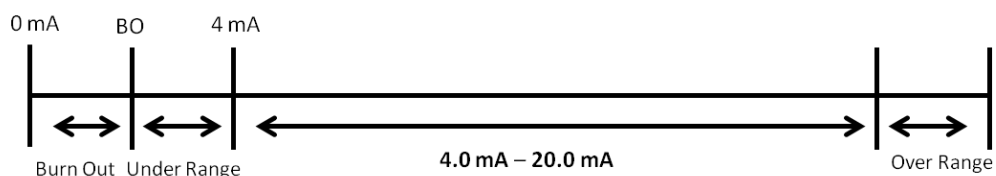

Users can define burnout values (BO, default 2 mA) for selected ranges. When input values are in the burnout range, raw data will register as 0000h to indicate analog input burnout. The definition of raw data is as follows:

Burnout Value (BO)	$0.0 < BO < 4.0$	User defined (default 2 mA)
Burnout State	$0 \leq AI < BO \text{ mA}$	S/W output 0000h
Under Range	$BO \leq AI < 4 \text{ mA}$	S/W output raw data
Normal Range	$4 \leq AI \leq 20.00 \text{ mA}$	S/W output raw data until FFEh
Over Range	$XX > 20.00 \text{ mA}$	S/W output FFFFh

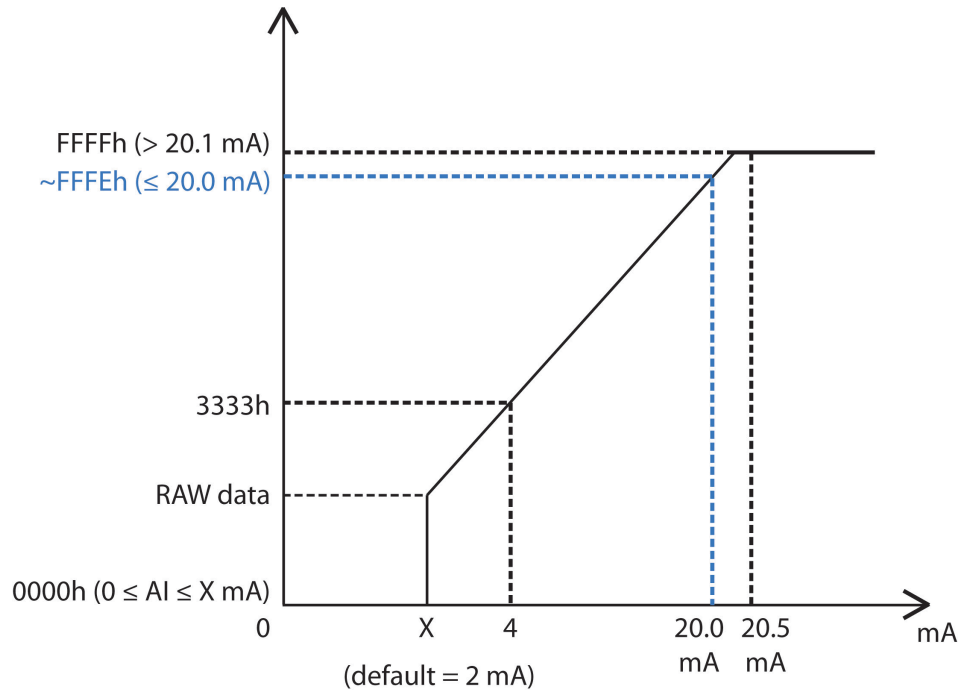

ATTENTION

When configuring the jumpers to select voltage or current measurement for the AI channels, open the cover by first removing the screw on the back panel. Details on jumper settings can be found in the **Jumper Settings (DIO and AI)** section.

Configuring Analog Output Channels

The current status of each AO (analog output) channel can be viewed on the I/O Setting:

Channel	Range	Value
[AO]: 00	0-10V	0.000 V
[AO]: 01	0-10V	0.000 V
[AO]: 02	0-10V	0.000 V
[AO]: 03	0-10V	0.000 V

Click on a specific channel to access the AO channel settings.

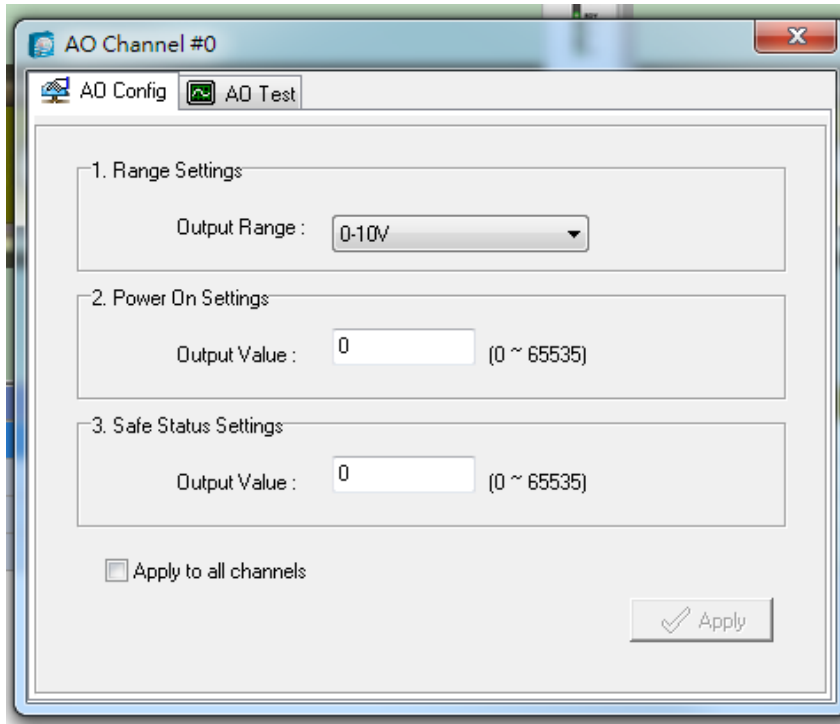

There are two modes for the AI channels, **Voltage Mode (V)** and **Current Mode (mA)**. See **Jumper Settings (DIO and AI)** in Chapter 2 for more information.

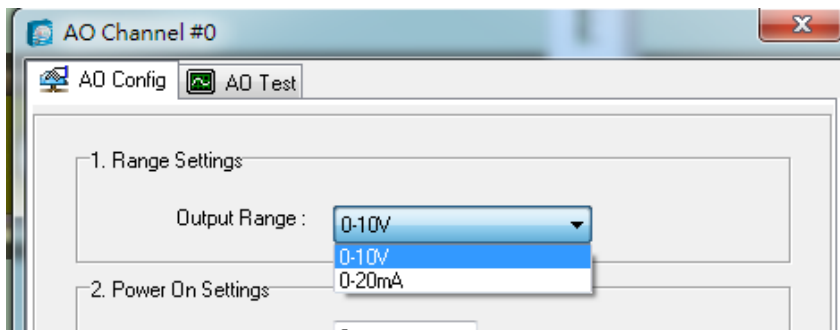

Power On Settings: For AO channels in Event Counter mode, you may configure whether or not counting begins at power up.

Safe Status Settings: For AO channels in Event Counter mode, you can configure whether or not counting starts or continues when Safe Status has been activated. When the network connection is lost as specified in the Host Connection Watchdog, the ioLogik R1200 will start or stop the counter according to the channel's Safe Status settings. Note that the Host Connection Watchdog is disabled by default, and must be enabled for Safe Status settings to have effect.

Test I/O: You can test AO channels in the **Test** tab. You may see how the status or counter value responds when the attached input device is manipulated.

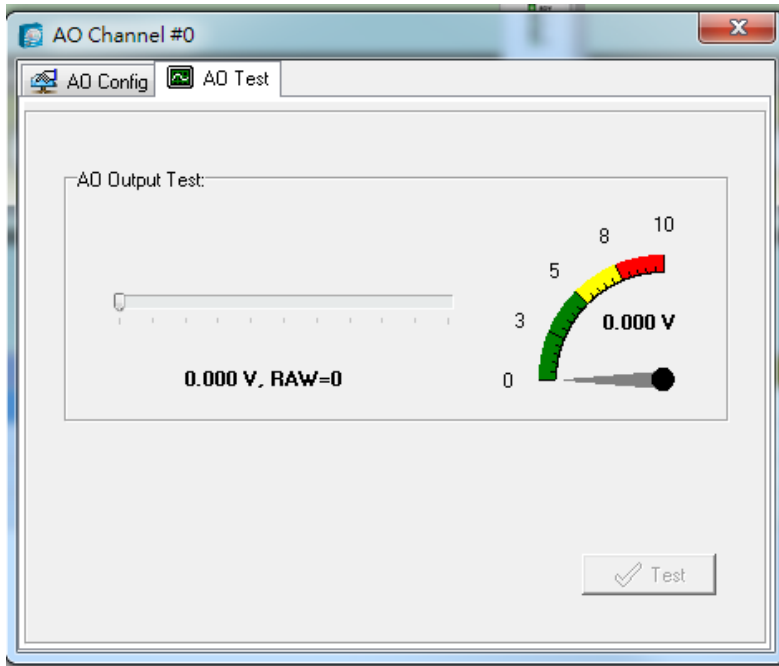

Server Info Tab

The **Server Information** tab provides the Modbus addresses for all system configurations. This helps you verify the access authority of each address. The screen also displays a clear explanation of each item.

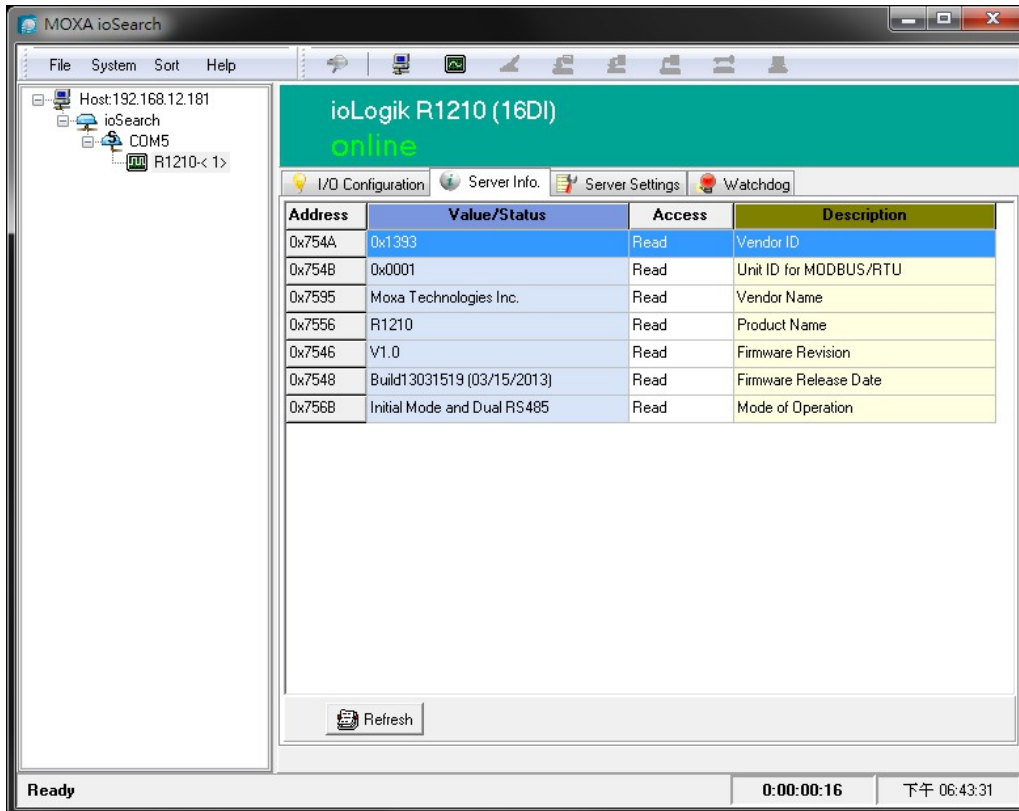

Server Settings Tab (General)

The **Server Settings** tab is where you log in as an administrator. This is required in order to gain access to the ioLogik R1200 configuration options. If no administrator password has been set up, simply click on **Login** and leave the **Password for entry** field blank. Additional information on ioSearch administrator functions is provided later in this chapter.

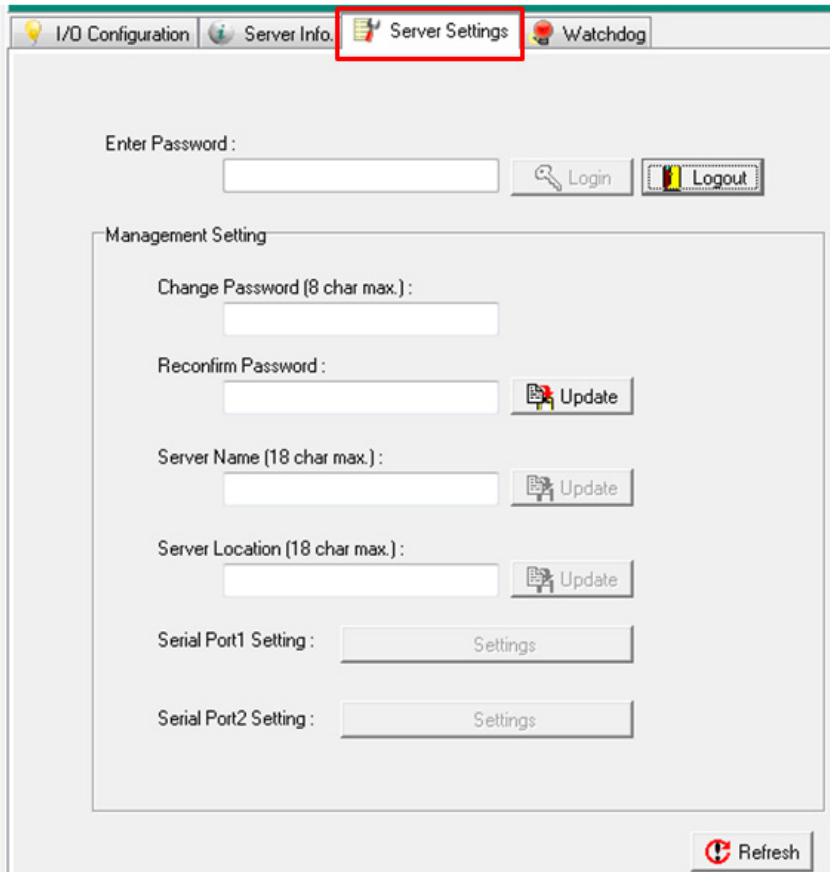

Click "Serial Port1 Setting" or "Serial Port2 Setting" to define and set the serial communication ports.

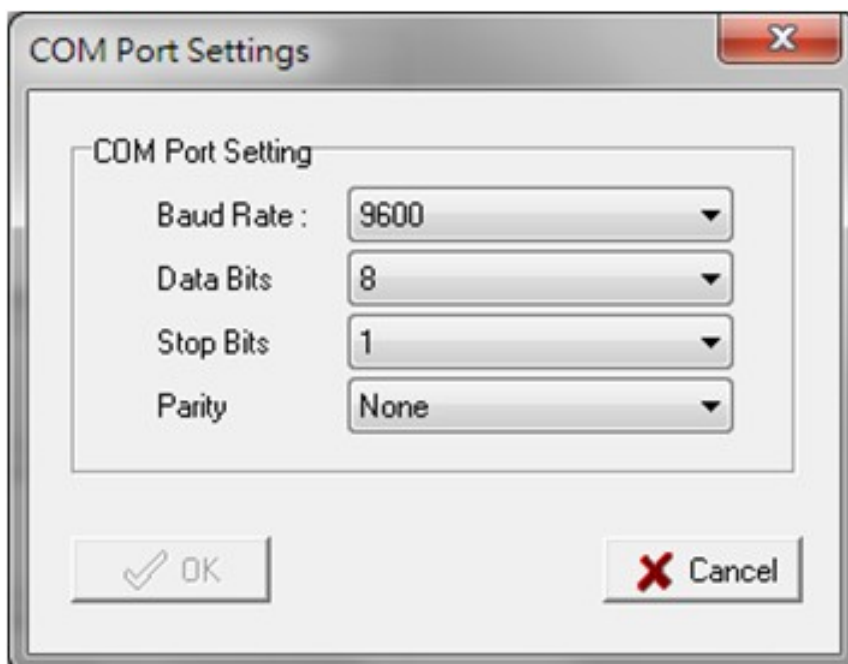

Watchdog

The **Watchdog** tab is where you configure the Host Connection Watchdog, which is used with the Safe Status settings to define each channel's response to a lost connection. When the ioLogik R1200 loses its connection as specified in the timeout, the Host Connection Watchdog will switch the ioLogik R1200 to Safe Status and all channels will reset to their Safe Status settings. By default, the Watchdog is disabled. To enable the Watchdog, make sure **Enable Host Connection Watchdog** is checked, set the Timeout value, then click the **Update** button.

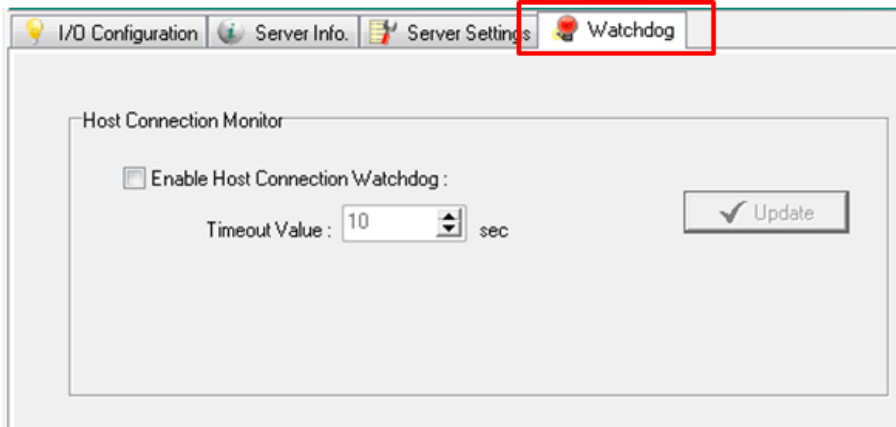

After the Watchdog is enabled, the ioLogik R2110 will enter safe status if the RS-485 connection is lost. Once the connection has been restored, you will need to return to the Watchdog tab in order to exit Safe Status.

There will be a message saying "Host Connection Lost" to indicate that the server is in safe status. Click **Clear Alarm** to exit safe status and return to normal operation.

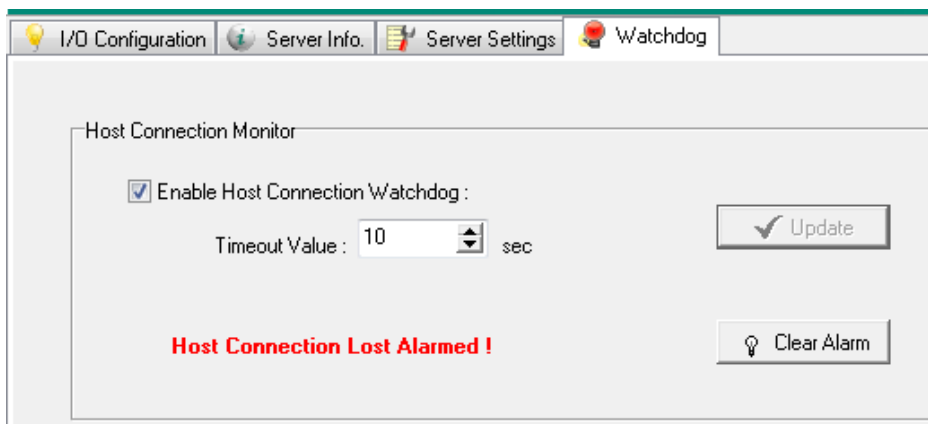

A

Modbus Mapping

The following topics are covered in this appendix:

- **ioLogik R1200 System Modbus Address and Register Map**
- **ioLogik R1210 Modbus Address and Register Map**
- **ioLogik R1212 Modbus Address and Register Map**
- **ioLogik R1214 Modbus Address and Register Map**
- **ioLogik R1240 Modbus Address and Register Map**
- **ioLogik R1241 Modbus Address and Register Map**

ioLogik R1200 System Modbus Address and Register Map

Address (hex)	Register (decimal)	Access	Type	Parameter Name	Function Code	Description
0x7530	330001	R	word	SYS_modelID	04:INPUT REGISTER	
0x7545	330022	R	word	SYS_firmwareVersion	04:INPUT REGISTER	2 words
0x7547	330024	R	word	SYS_firmwareReleaseDate	04:INPUT REGISTER	2 words
0x7549	330026	R	word	SYS_vendorID	04:INPUT REGISTER	
0x754A	330027	R	word	SYS_unitID	04:INPUT REGISTER	
0x754B	330028	R	word	SYS_serialNumber	04:INPUT REGISTER	6 words
0x7555	330038	R	word	SYS_productName	04:INPUT REGISTER	10 words
0x756A	330059	R	word	SYS_rs485PortMode	04:INPUT REGISTER	0: initial-repeater, 1: initial-dual RS-485, 2: run-repeater, 3: run-dual RS-485
0x7531	430002	R/W	word	SYS_serverName	03:HOLDING REGISTER	10 words
0x753B	430012	R/W	word	SYS_serverLocation	03:HOLDING REGISTER	10 words
0x755F	430048	R/W	word	SYS_password	03:HOLDING REGISTER	5 words
0x7564	430053	R/W	word	SYS_modbusWatchdogFuntion	03:HOLDING REGISTER	0: Disable, 1: Enable
0x7565	430054	R/W	word	SYS_modbusWatchdogTimeout	03:HOLDING REGISTER	unit: sec(s)
0x7566	430055	R/W	word	SYS_modbusWatchdogStatus	03:HOLDING REGISTER	0: Normal, 1: Timeout
0x7567	430056	R/W	word	SYS_locateDevice	03:HOLDING REGISTER	
0x7568	430057	R/W	word	SYS_restartDevice	03:HOLDING REGISTER	404: Enable
0x7569	430058	R/W	word	SYS_loadFactoryDefault	03:HOLDING REGISTER	404: Enable
0x756C	430061	R/W	word	SYS_port0Baudrate	03:HOLDING REGISTER	1: 1200, 2: 2400, 3: 4800, 4: 9600, 5: 19200, 6: 38400, 7: 57600, 8: 115200, 9: 921600
0x756D	430062	R/W	word	SYS_port1Baudrate	03:HOLDING REGISTER	1: 1200, 2: 2400, 3: 4800, 4: 9600, 5: 19200, 6: 38400, 7: 57600, 8: 115200, 9: 921600

Address (hex)	Register (decimal)	Access	Type	Parameter Name	Function Code	Description
0x7570	430065	R/W	word	SYS_port0StopBit	03:HOLDING REGISTER	0: 1, 1: 2
0x7571	430066	R/W	word	SYS_port1StopBit	03:HOLDING REGISTER	0: 1, 1: 2
0x7572	430067	R/W	word	SYS_port0Parity	03:HOLDING REGISTER	0: None, 1: Even, 2: Odd
0x7573	430068	R/W	word	SYS_port1Parity	03:HOLDING REGISTER	0: None, 1: Even, 2: Odd
0x7594	430101	R/W	word	SYS_vendorName	03:HOLDING REGISTER	20 words

ioLogik R1210 Modbus Address and Register Map

Address (hex)	Register (decimal)	Access	Type	Parameter Name	Function Code	Description
0x0000	00001	R/W	bit	DI-00_counterStatus	01:COIL STATUS	0: STOP, 1: START
0x0001	00002	R/W	bit	DI-01_counterStatus	01:COIL STATUS	0: STOP, 1: START
0x0002	00003	R/W	bit	DI-02_counterStatus	01:COIL STATUS	0: STOP, 1: START
0x0003	00004	R/W	bit	DI-03_counterStatus	01:COIL STATUS	0: STOP, 1: START
0x0004	00005	R/W	bit	DI-04_counterStatus	01:COIL STATUS	0: STOP, 1: START
0x0005	00006	R/W	bit	DI-05_counterStatus	01:COIL STATUS	0: STOP, 1: START
0x0006	00007	R/W	bit	DI-06_counterStatus	01:COIL STATUS	0: STOP, 1: START
0x0007	00008	R/W	bit	DI-07_counterStatus	01:COIL STATUS	0: STOP, 1: START
0x0008	00009	R/W	bit	DI-08_counterStatus	01:COIL STATUS	0: STOP, 1: START
0x0009	00010	R/W	bit	DI-09_counterStatus	01:COIL STATUS	0: STOP, 1: START
0x000A	00011	R/W	bit	DI-10_counterStatus	01:COIL STATUS	0: STOP, 1: START
0x000B	00012	R/W	bit	DI-11_counterStatus	01:COIL STATUS	0: STOP, 1: START
0x000C	00013	R/W	bit	DI-12_counterStatus	01:COIL STATUS	0: STOP, 1: START
0x000D	00014	R/W	bit	DI-13_counterStatus	01:COIL STATUS	0: STOP, 1: START
0x000E	00015	R/W	bit	DI-14_counterStatus	01:COIL STATUS	0: STOP, 1: START
0x000F	00016	R/W	bit	DI-15_counterStatus	01:COIL STATUS	0: STOP, 1: START
0x0020	00033	R/W	bit	DI-00_counterReset	01:COIL STATUS	1: reset to initial value

Address (hex)	Register (decimal)	Access	Type	Parameter Name	Function Code	Description
0x0021	00034	R/W	bit	DI-01_counterReset	01:COIL STATUS	1: reset to initial value
0x0022	00035	R/W	bit	DI-02_counterReset	01:COIL STATUS	1: reset to initial value
0x0023	00036	R/W	bit	DI-03_counterReset	01:COIL STATUS	1: reset to initial value
0x0024	00037	R/W	bit	DI-04_counterReset	01:COIL STATUS	1: reset to initial value
0x0025	00038	R/W	bit	DI-05_counterReset	01:COIL STATUS	1: reset to initial value
0x0026	00039	R/W	bit	DI-06_counterReset	01:COIL STATUS	1: reset to initial value
0x0027	00040	R/W	bit	DI-07_counterReset	01:COIL STATUS	1: reset to initial value
0x0028	00041	R/W	bit	DI-08_counterReset	01:COIL STATUS	1: reset to initial value
0x0029	00042	R/W	bit	DI-09_counterReset	01:COIL STATUS	1: reset to initial value
0x002A	00043	R/W	bit	DI-10_counterReset	01:COIL STATUS	1: reset to initial value
0x002B	00044	R/W	bit	DI-11_counterReset	01:COIL STATUS	1: reset to initial value
0x002C	00045	R/W	bit	DI-12_counterReset	01:COIL STATUS	1: reset to initial value
0x002D	00046	R/W	bit	DI-13_counterReset	01:COIL STATUS	1: reset to initial value
0x002E	00047	R/W	bit	DI-14_counterReset	01:COIL STATUS	1: reset to initial value
0x002F	00048	R/W	bit	DI-15_counterReset	01:COIL STATUS	1: reset to initial value
0x0040	00065	R/W	bit	DI-00_counterOverflowFlag	01:COIL STATUS	1: clear overflow flag
0x0041	00066	R/W	bit	DI-01_counterOverflowFlag	01:COIL STATUS	1: clear overflow flag
0x0042	00067	R/W	bit	DI-02_counterOverflowFlag	01:COIL STATUS	1: clear overflow flag
0x0043	00068	R/W	bit	DI-03_counterOverflowFlag	01:COIL STATUS	1: clear overflow flag
0x0044	00069	R/W	bit	DI-04_counterOverflowFlag	01:COIL STATUS	1: clear overflow flag
0x0045	00070	R/W	bit	DI-05_counterOverflowFlag	01:COIL STATUS	1: clear overflow flag
0x0046	00071	R/W	bit	DI-06_counterOverflowFlag	01:COIL STATUS	1: clear overflow flag
0x0047	00072	R/W	bit	DI-07_counterOverflowFlag	01:COIL STATUS	1: clear overflow flag
0x0048	00073	R/W	bit	DI-08_counterOverflowFlag	01:COIL STATUS	1: clear overflow flag
0x0049	00074	R/W	bit	DI-09_counterOverflowFlag	01:COIL STATUS	1: clear overflow flag
0x004A	00075	R/W	bit	DI-10_counterOverflowFlag	01:COIL STATUS	1: clear overflow flag

Address (hex)	Register (decimal)	Access	Type	Parameter Name	Function Code	Description
0x004B	00076	R/W	bit	DI-11_counterOverflowFlag	01:COIL STATUS	1: clear overflow flag
0x004C	00077	R/W	bit	DI-12_counterOverflowFlag	01:COIL STATUS	1: clear overflow flag
0x004D	00078	R/W	bit	DI-13_counterOverflowFlag	01:COIL STATUS	1: clear overflow flag
0x004E	00079	R/W	bit	DI-14_counterOverflowFlag	01:COIL STATUS	1: clear overflow flag
0x004F	00080	R/W	bit	DI-15_counterOverflowFlag	01:COIL STATUS	1: clear overflow flag
0x0060	00097	R/W	bit	DI-00_counterPowerOnStatus	01:COIL STATUS	0: STOP, 1: START
0x0061	00098	R/W	bit	DI-01_counterPowerOnStatus	01:COIL STATUS	0: STOP, 1: START
0x0062	00099	R/W	bit	DI-02_counterPowerOnStatus	01:COIL STATUS	0: STOP, 1: START
0x0063	00100	R/W	bit	DI-03_counterPowerOnStatus	01:COIL STATUS	0: STOP, 1: START
0x0064	00101	R/W	bit	DI-04_counterPowerOnStatus	01:COIL STATUS	0: STOP, 1: START
0x0065	00102	R/W	bit	DI-05_counterPowerOnStatus	01:COIL STATUS	0: STOP, 1: START
0x0066	00103	R/W	bit	DI-06_counterPowerOnStatus	01:COIL STATUS	0: STOP, 1: START
0x0067	00104	R/W	bit	DI-07_counterPowerOnStatus	01:COIL STATUS	0: STOP, 1: START
0x0068	00105	R/W	bit	DI-08_counterPowerOnStatus	01:COIL STATUS	0: STOP, 1: START
0x0069	00106	R/W	bit	DI-09_counterPowerOnStatus	01:COIL STATUS	0: STOP, 1: START
0x006A	00107	R/W	bit	DI-10_counterPowerOnStatus	01:COIL STATUS	0: STOP, 1: START
0x006B	00108	R/W	bit	DI-11_counterPowerOnStatus	01:COIL STATUS	0: STOP, 1: START
0x006C	00109	R/W	bit	DI-12_counterPowerOnStatus	01:COIL STATUS	0: STOP, 1: START
0x006D	00110	R/W	bit	DI-13_counterPowerOnStatus	01:COIL STATUS	0: STOP, 1: START
0x006E	00111	R/W	bit	DI-14_counterPowerOnStatus	01:COIL STATUS	0: STOP, 1: START
0x006F	00112	R/W	bit	DI-15_counterPowerOnStatus	01:COIL STATUS	0: STOP, 1: START
0x0080	00129	R/W	bit	DI-00_counterSafeModeStatus	01:COIL STATUS	0: STOP, 1: START
0x0081	00130	R/W	bit	DI-01_counterSafeModeStatus	01:COIL STATUS	0: STOP, 1: START
0x0082	00131	R/W	bit	DI-02_counterSafeModeStatus	01:COIL STATUS	0: STOP, 1: START
0x0083	00132	R/W	bit	DI-03_counterSafeModeStatus	01:COIL STATUS	0: STOP, 1: START
0x0084	00133	R/W	bit	DI-04_counterSafeModeStatus	01:COIL STATUS	0: STOP, 1: START

Address (hex)	Register (decimal)	Access	Type	Parameter Name	Function Code	Description
0x0085	00134	R/W	bit	DI-05_counterSafeModeStatus	01:COIL STATUS	0: STOP, 1: START
0x0086	00135	R/W	bit	DI-06_counterSafeModeStatus	01:COIL STATUS	0: STOP, 1: START
0x0087	00136	R/W	bit	DI-07_counterSafeModeStatus	01:COIL STATUS	0: STOP, 1: START
0x0088	00137	R/W	bit	DI-08_counterSafeModeStatus	01:COIL STATUS	0: STOP, 1: START
0x0089	00138	R/W	bit	DI-09_counterSafeModeStatus	01:COIL STATUS	0: STOP, 1: START
0x008A	00139	R/W	bit	DI-10_counterSafeModeStatus	01:COIL STATUS	0: STOP, 1: START
0x008B	00140	R/W	bit	DI-11_counterSafeModeStatus	01:COIL STATUS	0: STOP, 1: START
0x008C	00141	R/W	bit	DI-12_counterSafeModeStatus	01:COIL STATUS	0: STOP, 1: START
0x008D	00142	R/W	bit	DI-13_counterSafeModeStatus	01:COIL STATUS	0: STOP, 1: START
0x008E	00143	R/W	bit	DI-14_counterSafeModeStatus	01:COIL STATUS	0: STOP, 1: START
0x008F	00144	R/W	bit	DI-15_counterSafeModeStatus	01:COIL STATUS	0: STOP, 1: START
0x00A0	00161	R/W	bit	DI-00_counterPowerOffStorage	01:COIL STATUS	0: Disable, 1: Enable
0x00A1	00162	R/W	bit	DI-01_counterPowerOffStorage	01:COIL STATUS	0: Disable, 1: Enable
0x00A2	00163	R/W	bit	DI-02_counterPowerOffStorage	01:COIL STATUS	0: Disable, 1: Enable
0x00A3	00164	R/W	bit	DI-03_counterPowerOffStorage	01:COIL STATUS	0: Disable, 1: Enable
0x00A4	00165	R/W	bit	DI-04_counterPowerOffStorage	01:COIL STATUS	0: Disable, 1: Enable
0x00A5	00166	R/W	bit	DI-05_counterPowerOffStorage	01:COIL STATUS	0: Disable, 1: Enable
0x00A6	00167	R/W	bit	DI-06_counterPowerOffStorage	01:COIL STATUS	0: Disable, 1: Enable
0x00A7	00168	R/W	bit	DI-07_counterPowerOffStorage	01:COIL STATUS	0: Disable, 1: Enable
0x00A8	00169	R/W	bit	DI-08_counterPowerOffStorage	01:COIL STATUS	0: Disable, 1: Enable
0x00A9	00170	R/W	bit	DI-09_counterPowerOffStorage	01:COIL STATUS	0: Disable, 1: Enable
0x00AA	00171	R/W	bit	DI-10_counterPowerOffStorage	01:COIL STATUS	0: Disable, 1: Enable
0x00AB	00172	R/W	bit	DI-11_counterPowerOffStorage	01:COIL STATUS	0: Disable, 1: Enable
0x00AC	00173	R/W	bit	DI-12_counterPowerOffStorage	01:COIL STATUS	0: Disable, 1: Enable
0x00AD	00174	R/W	bit	DI-13_counterPowerOffStorage	01:COIL STATUS	0: Disable, 1: Enable
0x00AE	00175	R/W	bit	DI-14_counterPowerOffStorage	01:COIL STATUS	0: Disable, 1: Enable

Address (hex)	Register (decimal)	Access	Type	Parameter Name	Function Code	Description
0x00AF	00176	R/W	bit	DI-15_counterPowerOffStorage	01:COIL STATUS	0: Disable, 1: Enable
0x0000	10001	R	bit	DI-00_status	02:INPUT STATUS	0: OFF, 1: ON
0x0001	10002	R	bit	DI-01_status	02:INPUT STATUS	0: OFF, 1: ON
0x0002	10003	R	bit	DI-02_status	02:INPUT STATUS	0: OFF, 1: ON
0x0003	10004	R	bit	DI-03_status	02:INPUT STATUS	0: OFF, 1: ON
0x0004	10005	R	bit	DI-04_status	02:INPUT STATUS	0: OFF, 1: ON
0x0005	10006	R	bit	DI-05_status	02:INPUT STATUS	0: OFF, 1: ON
0x0006	10007	R	bit	DI-06_status	02:INPUT STATUS	0: OFF, 1: ON
0x0007	10008	R	bit	DI-07_status	02:INPUT STATUS	0: OFF, 1: ON
0x0008	10009	R	bit	DI-08_status	02:INPUT STATUS	0: OFF, 1: ON
0x0009	10010	R	bit	DI-09_status	02:INPUT STATUS	0: OFF, 1: ON
0x000A	10011	R	bit	DI-10_status	02:INPUT STATUS	0: OFF, 1: ON
0x000B	10012	R	bit	DI-11_status	02:INPUT STATUS	0: OFF, 1: ON
0x000C	10013	R	bit	DI-12_status	02:INPUT STATUS	0: OFF, 1: ON
0x000D	10014	R	bit	DI-13_status	02:INPUT STATUS	0: OFF, 1: ON
0x000E	10015	R	bit	DI-14_status	02:INPUT STATUS	0: OFF, 1: ON
0x000F	10016	R	bit	DI-15_status	02:INPUT STATUS	0: OFF, 1: ON
0x0000	30001	R	word	DI-00_status	04:INPUT REGISTER	0: OFF, 1: ON
0x0001	30002	R	word	DI-01_status	04:INPUT REGISTER	0: OFF, 1: ON
0x0002	30003	R	word	DI-02_status	04:INPUT REGISTER	0: OFF, 1: ON
0x0003	30004	R	word	DI-03_status	04:INPUT REGISTER	0: OFF, 1: ON
0x0004	30005	R	word	DI-04_status	04:INPUT REGISTER	0: OFF, 1: ON
0x0005	30006	R	word	DI-05_status	04:INPUT REGISTER	0: OFF, 1: ON
0x0006	30007	R	word	DI-06_status	04:INPUT REGISTER	0: OFF, 1: ON
0x0007	30008	R	word	DI-07_status	04:INPUT REGISTER	0: OFF, 1: ON
0x0008	30009	R	word	DI-08_status	04:INPUT REGISTER	0: OFF, 1: ON

Address (hex)	Register (decimal)	Access	Type	Parameter Name	Function Code	Description
0x0009	30010	R	word	DI-09_status	04:INPUT REGISTER	0: OFF, 1: ON
0x000A	30011	R	word	DI-10_status	04:INPUT REGISTER	0: OFF, 1: ON
0x000B	30012	R	word	DI-11_status	04:INPUT REGISTER	0: OFF, 1: ON
0x000C	30013	R	word	DI-12_status	04:INPUT REGISTER	0: OFF, 1: ON
0x000D	30014	R	word	DI-13_status	04:INPUT REGISTER	0: OFF, 1: ON
0x000E	30015	R	word	DI-14_status	04:INPUT REGISTER	0: OFF, 1: ON
0x000F	30016	R	word	DI-15_status	04:INPUT REGISTER	0: OFF, 1: ON
0x0020	30033	R	word	DI-00_counterValueHigh	04:INPUT REGISTER	high word
0x0021	30034	R	word	DI-00_counterValueLow	04:INPUT REGISTER	low word
0x0022	30035	R	word	DI-01_counterValueHigh	04:INPUT REGISTER	high word
0x0023	30036	R	word	DI-01_counterValueLow	04:INPUT REGISTER	low word
0x0024	30037	R	word	DI-02_counterValueHigh	04:INPUT REGISTER	high word
0x0025	30038	R	word	DI-02_counterValueLow	04:INPUT REGISTER	low word
0x0026	30039	R	word	DI-03_counterValueHigh	04:INPUT REGISTER	high word
0x0027	30040	R	word	DI-03_counterValueLow	04:INPUT REGISTER	low word
0x0028	30041	R	word	DI-04_counterValueHigh	04:INPUT REGISTER	high word
0x0029	30042	R	word	DI-04_counterValueLow	04:INPUT REGISTER	low word
0x002A	30043	R	word	DI-05_counterValueHigh	04:INPUT REGISTER	high word
0x002B	30044	R	word	DI-05_counterValueLow	04:INPUT REGISTER	low word
0x002C	30045	R	word	DI-06_counterValueHigh	04:INPUT REGISTER	high word
0x002D	30046	R	word	DI-06_counterValueLow	04:INPUT REGISTER	low word
0x002E	30047	R	word	DI-07_counterValueHigh	04:INPUT REGISTER	high word
0x002F	30048	R	word	DI-07_counterValueLow	04:INPUT REGISTER	low word
0x0030	30049	R	word	DI-08_counterValueHigh	04:INPUT REGISTER	high word
0x0031	30050	R	word	DI-08_counterValueLow	04:INPUT REGISTER	low word
0x0032	30051	R	word	DI-09_counterValueHigh	04:INPUT REGISTER	high word

Address (hex)	Register (decimal)	Access	Type	Parameter Name	Function Code	Description
0x0033	30052	R	word	DI-09_counterValueLow	04:INPUT REGISTER	low word
0x0034	30053	R	word	DI-10_counterValueHigh	04:INPUT REGISTER	high word
0x0035	30054	R	word	DI-10_counterValueLow	04:INPUT REGISTER	low word
0x0036	30055	R	word	DI-11_counterValueHigh	04:INPUT REGISTER	high word
0x0037	30056	R	word	DI-11_counterValueLow	04:INPUT REGISTER	low word
0x0038	30057	R	word	DI-12_counterValueHigh	04:INPUT REGISTER	high word
0x0039	30058	R	word	DI-12_counterValueLow	04:INPUT REGISTER	low word
0x003A	30059	R	word	DI-13_counterValueHigh	04:INPUT REGISTER	high word
0x003B	30060	R	word	DI-13_counterValueLow	04:INPUT REGISTER	low word
0x003C	30061	R	word	DI-14_counterValueHigh	04:INPUT REGISTER	high word
0x003D	30062	R	word	DI-14_counterValueLow	04:INPUT REGISTER	low word
0x003E	30063	R	word	DI-15_counterValueHigh	04:INPUT REGISTER	high word
0x003F	30064	R	word	DI-15_counterValueLow	04:INPUT REGISTER	low word
0x0000	40001	R/W	word	DI-00_mode	03:HOLDING REGISTER	0: DI, 1: Counter
0x0001	40002	R/W	word	DI-01_mode	03:HOLDING REGISTER	0: DI, 1: Counter
0x0002	40003	R/W	word	DI-02_mode	03:HOLDING REGISTER	0: DI, 1: Counter
0x0003	40004	R/W	word	DI-03_mode	03:HOLDING REGISTER	0: DI, 1: Counter
0x0004	40005	R/W	word	DI-04_mode	03:HOLDING REGISTER	0: DI, 1: Counter
0x0005	40006	R/W	word	DI-05_mode	03:HOLDING REGISTER	0: DI, 1: Counter
0x0006	40007	R/W	word	DI-06_mode	03:HOLDING REGISTER	0: DI, 1: Counter
0x0007	40008	R/W	word	DI-07_mode	03:HOLDING REGISTER	0: DI, 1: Counter
0x0008	40009	R/W	word	DI-08_mode	03:HOLDING REGISTER	0: DI, 1: Counter
0x0009	40010	R/W	word	DI-09_mode	03:HOLDING REGISTER	0: DI, 1: Counter
0x000A	40011	R/W	word	DI-10_mode	03:HOLDING REGISTER	0: DI, 1: Counter
0x000B	40012	R/W	word	DI-11_mode	03:HOLDING REGISTER	0: DI, 1: Counter
0x000C	40013	R/W	word	DI-12_mode	03:HOLDING REGISTER	0: DI, 1: Counter

Address (hex)	Register (decimal)	Access	Type	Parameter Name	Function Code	Description
0x000D	40014	R/W	word	DI-13_mode	03:HOLDIN G REGISTER	0: DI, 1: Counter
0x000E	40015	R/W	word	DI-14_mode	03:HOLDIN G REGISTER	0: DI, 1: Counter
0x000F	40016	R/W	word	DI-15_mode	03:HOLDIN G REGISTER	0: DI, 1: Counter
0x0020	40033	R/W	word	DI-00_filter	03:HOLDIN G REGISTER	unit: 100 us
0x0021	40034	R/W	word	DI-01_filter	03:HOLDIN G REGISTER	unit: 100 us
0x0022	40035	R/W	word	DI-02_filter	03:HOLDIN G REGISTER	unit: 100 us
0x0023	40036	R/W	word	DI-03_filter	03:HOLDIN G REGISTER	unit: 100 us
0x0024	40037	R/W	word	DI-04_filter	03:HOLDIN G REGISTER	unit: 100 us
0x0025	40038	R/W	word	DI-05_filter	03:HOLDIN G REGISTER	unit: 100 us
0x0026	40039	R/W	word	DI-06_filter	03:HOLDIN G REGISTER	unit: 100 us
0x0027	40040	R/W	word	DI-07_filter	03:HOLDIN G REGISTER	unit: 100 us
0x0028	40041	R/W	word	DI-08_filter	03:HOLDIN G REGISTER	unit: 100 us
0x0029	40042	R/W	word	DI-09_filter	03:HOLDIN G REGISTER	unit: 100 us
0x002A	40043	R/W	word	DI-10_filter	03:HOLDIN G REGISTER	unit: 100 us
0x002B	40044	R/W	word	DI-11_filter	03:HOLDIN G REGISTER	unit: 100 us
0x002C	40045	R/W	word	DI-12_filter	03:HOLDIN G REGISTER	unit: 100 us
0x002D	40046	R/W	word	DI-13_filter	03:HOLDIN G REGISTER	unit: 100 us
0x002E	40047	R/W	word	DI-14_filter	03:HOLDIN G REGISTER	unit: 100 us
0x002F	40048	R/W	word	DI-15_filter	03:HOLDIN G REGISTER	unit: 100 us
0x0040	40065	R/W	word	DI-00_counterEvent	03:HOLDIN G REGISTER	0: Rising Edge, 1: Falling Edge, 2: Both
0x0041	40066	R/W	word	DI-01_counterEvent	03:HOLDIN G REGISTER	0: Rising Edge, 1: Falling Edge, 2: Both
0x0042	40067	R/W	word	DI-02_counterEvent	03:HOLDIN G REGISTER	0: Rising Edge, 1: Falling Edge, 2: Both
0x0043	40068	R/W	word	DI-03_counterEvent	03:HOLDIN G REGISTER	0: Rising Edge, 1: Falling Edge, 2: Both

Address (hex)	Register (decimal)	Access	Type	Parameter Name	Function Code	Description
0x0044	40069	R/W	word	DI-04_counterEvent	03:HOLDIN G REGISTER	0: Rising Edge, 1: Falling Edge, 2: Both
0x0045	40070	R/W	word	DI-05_counterEvent	03:HOLDIN G REGISTER	0: Rising Edge, 1: Falling Edge, 2: Both
0x0046	40071	R/W	word	DI-06_counterEvent	03:HOLDIN G REGISTER	0: Rising Edge, 1: Falling Edge, 2: Both
0x0047	40072	R/W	word	DI-07_counterEvent	03:HOLDIN G REGISTER	0: Rising Edge, 1: Falling Edge, 2: Both
0x0048	40073	R/W	word	DI-08_counterEvent	03:HOLDIN G REGISTER	0: Rising Edge, 1: Falling Edge, 2: Both
0x0049	40074	R/W	word	DI-09_counterEvent	03:HOLDIN G REGISTER	0: Rising Edge, 1: Falling Edge, 2: Both
0x004A	40075	R/W	word	DI-10_counterEvent	03:HOLDIN G REGISTER	0: Rising Edge, 1: Falling Edge, 2: Both
0x004B	40076	R/W	word	DI-11_counterEvent	03:HOLDIN G REGISTER	0: Rising Edge, 1: Falling Edge, 2: Both
0x004C	40077	R/W	word	DI-12_counterEvent	03:HOLDIN G REGISTER	0: Rising Edge, 1: Falling Edge, 2: Both
0x004D	40078	R/W	word	DI-13_counterEvent	03:HOLDIN G REGISTER	0: Rising Edge, 1: Falling Edge, 2: Both
0x004E	40079	R/W	word	DI-14_counterEvent	03:HOLDIN G REGISTER	0: Rising Edge, 1: Falling Edge, 2: Both
0x004F	40080	R/W	word	DI-15_counterEvent	03:HOLDIN G REGISTER	0: Rising Edge, 1: Falling Edge, 2: Both

ioLogik R1212 Modbus Address and Register Map

Address (hex)	Register (decimal)	Access	Type	Parameter Name	Function Code	Description
0x0000	00001	R/W	bit	DI-00_counterStatus	01:COIL STATUS	0: STOP, 1: START
0x0001	00002	R/W	bit	DI-01_counterStatus	01:COIL STATUS	0: STOP, 1: START
0x0002	00003	R/W	bit	DI-02_counterStatus	01:COIL STATUS	0: STOP, 1: START
0x0003	00004	R/W	bit	DI-03_counterStatus	01:COIL STATUS	0: STOP, 1: START

Address (hex)	Register (decimal)	Access	Type	Parameter Name	Function Code	Description
0x0004	00005	R/W	bit	DI-04_counterStatus	01:COIL STATUS	0: STOP, 1: START
0x0005	00006	R/W	bit	DI-05_counterStatus	01:COIL STATUS	0: STOP, 1: START
0x0006	00007	R/W	bit	DI-06_counterStatus	01:COIL STATUS	0: STOP, 1: START
0x0007	00008	R/W	bit	DI-07_counterStatus	01:COIL STATUS	0: STOP, 1: START
0x0008	00009	R/W	bit	DI-08_counterStatus	01:COIL STATUS	0: STOP, 1: START
0x0009	00010	R/W	bit	DI-09_counterStatus	01:COIL STATUS	0: STOP, 1: START
0x000A	00011	R/W	bit	DI-10_counterStatus	01:COIL STATUS	0: STOP, 1: START
0x000B	00012	R/W	bit	DI-11_counterStatus	01:COIL STATUS	0: STOP, 1: START
0x000C	00013	R/W	bit	DI-12_counterStatus	01:COIL STATUS	0: STOP, 1: START
0x000D	00014	R/W	bit	DI-13_counterStatus	01:COIL STATUS	0: STOP, 1: START
0x000E	00015	R/W	bit	DI-14_counterStatus	01:COIL STATUS	0: STOP, 1: START
0x000F	00016	R/W	bit	DI-15_counterStatus	01:COIL STATUS	0: STOP, 1: START
0x0020	00033	R/W	bit	DI-00_counterReset	01:COIL STATUS	1: reset to initial value
0x0021	00034	R/W	bit	DI-01_counterReset	01:COIL STATUS	1: reset to initial value
0x0022	00035	R/W	bit	DI-02_counterReset	01:COIL STATUS	1: reset to initial value
0x0023	00036	R/W	bit	DI-03_counterReset	01:COIL STATUS	1: reset to initial value
0x0024	00037	R/W	bit	DI-04_counterReset	01:COIL STATUS	1: reset to initial value
0x0025	00038	R/W	bit	DI-05_counterReset	01:COIL STATUS	1: reset to initial value
0x0026	00039	R/W	bit	DI-06_counterReset	01:COIL STATUS	1: reset to initial value
0x0027	00040	R/W	bit	DI-07_counterReset	01:COIL STATUS	1: reset to initial value
0x0028	00041	R/W	bit	DI-08_counterReset	01:COIL STATUS	1: reset to initial value
0x0029	00042	R/W	bit	DI-09_counterReset	01:COIL STATUS	1: reset to initial value
0x002A	00043	R/W	bit	DI-10_counterReset	01:COIL STATUS	1: reset to initial value
0x002B	00044	R/W	bit	DI-11_counterReset	01:COIL STATUS	1: reset to initial value
0x002C	00045	R/W	bit	DI-12_counterReset	01:COIL STATUS	1: reset to initial value
0x002D	00046	R/W	bit	DI-13_counterReset	01:COIL STATUS	1: reset to initial value

Address (hex)	Register (decimal)	Access	Type	Parameter Name	Function Code	Description
0x002E	00047	R/W	bit	DI-14_counterReset	01:COIL STATUS	1: reset to initial value
0x002F	00048	R/W	bit	DI-15_counterReset	01:COIL STATUS	1: reset to initial value
0x0040	00065	R/W	bit	DI-00_counterOverflowFlag	01:COIL STATUS	1: clear overflow flag
0x0041	00066	R/W	bit	DI-01_counterOverflowFlag	01:COIL STATUS	1: clear overflow flag
0x0042	00067	R/W	bit	DI-02_counterOverflowFlag	01:COIL STATUS	1: clear overflow flag
0x0043	00068	R/W	bit	DI-03_counterOverflowFlag	01:COIL STATUS	1: clear overflow flag
0x0044	00069	R/W	bit	DI-04_counterOverflowFlag	01:COIL STATUS	1: clear overflow flag
0x0045	00070	R/W	bit	DI-05_counterOverflowFlag	01:COIL STATUS	1: clear overflow flag
0x0046	00071	R/W	bit	DI-06_counterOverflowFlag	01:COIL STATUS	1: clear overflow flag
0x0047	00072	R/W	bit	DI-07_counterOverflowFlag	01:COIL STATUS	1: clear overflow flag
0x0048	00073	R/W	bit	DI-08_counterOverflowFlag	01:COIL STATUS	1: clear overflow flag
0x0049	00074	R/W	bit	DI-09_counterOverflowFlag	01:COIL STATUS	1: clear overflow flag
0x004A	00075	R/W	bit	DI-10_counterOverflowFlag	01:COIL STATUS	1: clear overflow flag
0x004B	00076	R/W	bit	DI-11_counterOverflowFlag	01:COIL STATUS	1: clear overflow flag
0x004C	00077	R/W	bit	DI-12_counterOverflowFlag	01:COIL STATUS	1: clear overflow flag
0x004D	00078	R/W	bit	DI-13_counterOverflowFlag	01:COIL STATUS	1: clear overflow flag
0x004E	00079	R/W	bit	DI-14_counterOverflowFlag	01:COIL STATUS	1: clear overflow flag
0x004F	00080	R/W	bit	DI-15_counterOverflowFlag	01:COIL STATUS	1: clear overflow flag
0x0060	00097	R/W	bit	DI-00_counterPowerOnStatus	01:COIL STATUS	0: STOP, 1: START
0x0061	00098	R/W	bit	DI-01_counterPowerOnStatus	01:COIL STATUS	0: STOP, 1: START
0x0062	00099	R/W	bit	DI-02_counterPowerOnStatus	01:COIL STATUS	0: STOP, 1: START
0x0063	00100	R/W	bit	DI-03_counterPowerOnStatus	01:COIL STATUS	0: STOP, 1: START
0x0064	00101	R/W	bit	DI-04_counterPowerOnStatus	01:COIL STATUS	0: STOP, 1: START
0x0065	00102	R/W	bit	DI-05_counterPowerOnStatus	01:COIL STATUS	0: STOP, 1: START
0x0066	00103	R/W	bit	DI-06_counterPowerOnStatus	01:COIL STATUS	0: STOP, 1: START
0x0067	00104	R/W	bit	DI-07_counterPowerOnStatus	01:COIL STATUS	0: STOP, 1: START

Address (hex)	Register (decimal)	Access	Type	Parameter Name	Function Code	Description
0x0068	00105	R/W	bit	DI-08_counterPowerOnStatus	01:COIL STATUS	0: STOP, 1: START
0x0069	00106	R/W	bit	DI-09_counterPowerOnStatus	01:COIL STATUS	0: STOP, 1: START
0x006A	00107	R/W	bit	DI-10_counterPowerOnStatus	01:COIL STATUS	0: STOP, 1: START
0x006B	00108	R/W	bit	DI-11_counterPowerOnStatus	01:COIL STATUS	0: STOP, 1: START
0x006C	00109	R/W	bit	DI-12_counterPowerOnStatus	01:COIL STATUS	0: STOP, 1: START
0x006D	00110	R/W	bit	DI-13_counterPowerOnStatus	01:COIL STATUS	0: STOP, 1: START
0x006E	00111	R/W	bit	DI-14_counterPowerOnStatus	01:COIL STATUS	0: STOP, 1: START
0x006F	00112	R/W	bit	DI-15_counterPowerOnStatus	01:COIL STATUS	0: STOP, 1: START
0x0080	00129	R/W	bit	DI-00_counterSafeModeStatus	01:COIL STATUS	0: STOP, 1: START
0x0081	00130	R/W	bit	DI-01_counterSafeModeStatus	01:COIL STATUS	0: STOP, 1: START
0x0082	00131	R/W	bit	DI-02_counterSafeModeStatus	01:COIL STATUS	0: STOP, 1: START
0x0083	00132	R/W	bit	DI-03_counterSafeModeStatus	01:COIL STATUS	0: STOP, 1: START
0x0084	00133	R/W	bit	DI-04_counterSafeModeStatus	01:COIL STATUS	0: STOP, 1: START
0x0085	00134	R/W	bit	DI-05_counterSafeModeStatus	01:COIL STATUS	0: STOP, 1: START
0x0086	00135	R/W	bit	DI-06_counterSafeModeStatus	01:COIL STATUS	0: STOP, 1: START
0x0087	00136	R/W	bit	DI-07_counterSafeModeStatus	01:COIL STATUS	0: STOP, 1: START
0x0088	00137	R/W	bit	DI-08_counterSafeModeStatus	01:COIL STATUS	0: STOP, 1: START
0x0089	00138	R/W	bit	DI-09_counterSafeModeStatus	01:COIL STATUS	0: STOP, 1: START
0x008A	00139	R/W	bit	DI-10_counterSafeModeStatus	01:COIL STATUS	0: STOP, 1: START
0x008B	00140	R/W	bit	DI-11_counterSafeModeStatus	01:COIL STATUS	0: STOP, 1: START
0x008C	00141	R/W	bit	DI-12_counterSafeModeStatus	01:COIL STATUS	0: STOP, 1: START
0x008D	00142	R/W	bit	DI-13_counterSafeModeStatus	01:COIL STATUS	0: STOP, 1: START
0x008E	00143	R/W	bit	DI-14_counterSafeModeStatus	01:COIL STATUS	0: STOP, 1: START
0x008F	00144	R/W	bit	DI-15_counterSafeModeStatus	01:COIL STATUS	0: STOP, 1: START
0x00A0	00161	R/W	bit	DI-00_counterPowerOffStorage	01:COIL STATUS	0: Disable, 1: Enable
0x00A1	00162	R/W	bit	DI-01_counterPowerOffStorage	01:COIL STATUS	0: Disable, 1: Enable

Address (hex)	Register (decimal)	Access	Type	Parameter Name	Function Code	Description
0x00A2	00163	R/W	bit	DI-02_counterPowerOffStorage	01:COIL STATUS	0: Disable, 1: Enable
0x00A3	00164	R/W	bit	DI-03_counterPowerOffStorage	01:COIL STATUS	0: Disable, 1: Enable
0x00A4	00165	R/W	bit	DI-04_counterPowerOffStorage	01:COIL STATUS	0: Disable, 1: Enable
0x00A5	00166	R/W	bit	DI-05_counterPowerOffStorage	01:COIL STATUS	0: Disable, 1: Enable
0x00A6	00167	R/W	bit	DI-06_counterPowerOffStorage	01:COIL STATUS	0: Disable, 1: Enable
0x00A7	00168	R/W	bit	DI-07_counterPowerOffStorage	01:COIL STATUS	0: Disable, 1: Enable
0x00A8	00169	R/W	bit	DI-08_counterPowerOffStorage	01:COIL STATUS	0: Disable, 1: Enable
0x00A9	00170	R/W	bit	DI-09_counterPowerOffStorage	01:COIL STATUS	0: Disable, 1: Enable
0x00AA	00171	R/W	bit	DI-10_counterPowerOffStorage	01:COIL STATUS	0: Disable, 1: Enable
0x00AB	00172	R/W	bit	DI-11_counterPowerOffStorage	01:COIL STATUS	0: Disable, 1: Enable
0x00AC	00173	R/W	bit	DI-12_counterPowerOffStorage	01:COIL STATUS	0: Disable, 1: Enable
0x00AD	00174	R/W	bit	DI-13_counterPowerOffStorage	01:COIL STATUS	0: Disable, 1: Enable
0x00AE	00175	R/W	bit	DI-14_counterPowerOffStorage	01:COIL STATUS	0: Disable, 1: Enable
0x00AF	00176	R/W	bit	DI-15_counterPowerOffStorage	01:COIL STATUS	0: Disable, 1: Enable
0x0140	00321	R/W	bit	DO-00_status	01:COIL STATUS	0: OFF, 1: ON
0x0141	00322	R/W	bit	DO-01_status	01:COIL STATUS	0: OFF, 1: ON
0x0142	00323	R/W	bit	DO-02_status	01:COIL STATUS	0: OFF, 1: ON
0x0143	00324	R/W	bit	DO-03_status	01:COIL STATUS	0: OFF, 1: ON
0x0144	00325	R/W	bit	DO-04_status	01:COIL STATUS	0: OFF, 1: ON
0x0145	00326	R/W	bit	DO-05_status	01:COIL STATUS	0: OFF, 1: ON
0x0146	00327	R/W	bit	DO-06_status	01:COIL STATUS	0: OFF, 1: ON
0x0147	00328	R/W	bit	DO-07_status	01:COIL STATUS	0: OFF, 1: ON
0x0160	00353	R/W	bit	DO-00_powerOnStatus	01:COIL STATUS	0: OFF, 1: ON
0x0161	00354	R/W	bit	DO-01_powerOnStatus	01:COIL STATUS	0: OFF, 1: ON
0x0162	00355	R/W	bit	DO-02_powerOnStatus	01:COIL STATUS	0: OFF, 1: ON
0x0163	00356	R/W	bit	DO-03_powerOnStatus	01:COIL STATUS	0: OFF, 1: ON

Address (hex)	Register (decimal)	Access	Type	Parameter Name	Function Code	Description
0x0164	00357	R/W	bit	DO-04_powerOnStatus	01:COIL STATUS	0: OFF, 1: ON
0x0165	00358	R/W	bit	DO-05_powerOnStatus	01:COIL STATUS	0: OFF, 1: ON
0x0166	00359	R/W	bit	DO-06_powerOnStatus	01:COIL STATUS	0: OFF, 1: ON
0x0167	00360	R/W	bit	DO-07_powerOnStatus	01:COIL STATUS	0: OFF, 1: ON
0x0180	00385	R/W	bit	DO-00_pulseStatus	01:COIL STATUS	0: STOP, 1: START
0x0181	00386	R/W	bit	DO-01_pulseStatus	01:COIL STATUS	0: STOP, 1: START
0x0182	00387	R/W	bit	DO-02_pulseStatus	01:COIL STATUS	0: STOP, 1: START
0x0183	00388	R/W	bit	DO-03_pulseStatus	01:COIL STATUS	0: STOP, 1: START
0x0184	00389	R/W	bit	DO-04_pulseStatus	01:COIL STATUS	0: STOP, 1: START
0x0185	00390	R/W	bit	DO-05_pulseStatus	01:COIL STATUS	0: STOP, 1: START
0x0186	00391	R/W	bit	DO-06_pulseStatus	01:COIL STATUS	0: STOP, 1: START
0x0187	00392	R/W	bit	DO-07_pulseStatus	01:COIL STATUS	0: STOP, 1: START
0x01A0	00417	R/W	bit	DO-00_pulsePowerOnStatus	01:COIL STATUS	0: STOP, 1: START
0x01A1	00418	R/W	bit	DO-01_pulsePowerOnStatus	01:COIL STATUS	0: STOP, 1: START
0x01A2	00419	R/W	bit	DO-02_pulsePowerOnStatus	01:COIL STATUS	0: STOP, 1: START
0x01A3	00420	R/W	bit	DO-03_pulsePowerOnStatus	01:COIL STATUS	0: STOP, 1: START
0x01A4	00421	R/W	bit	DO-04_pulsePowerOnStatus	01:COIL STATUS	0: STOP, 1: START
0x01A5	00422	R/W	bit	DO-05_pulsePowerOnStatus	01:COIL STATUS	0: STOP, 1: START
0x01A6	00423	R/W	bit	DO-06_pulsePowerOnStatus	01:COIL STATUS	0: STOP, 1: START
0x01A7	00424	R/W	bit	DO-07_pulsePowerOnStatus	01:COIL STATUS	0: STOP, 1: START
0x01C0	00449	R/W	bit	DO-00_pulseSafeModeStatus	01:COIL STATUS	0: STOP, 1: START
0x01C1	00450	R/W	bit	DO-01_pulseSafeModeStatus	01:COIL STATUS	0: STOP, 1: START
0x01C2	00451	R/W	bit	DO-02_pulseSafeModeStatus	01:COIL STATUS	0: STOP, 1: START
0x01C3	00452	R/W	bit	DO-03_pulseSafeModeStatus	01:COIL STATUS	0: STOP, 1: START
0x01C4	00453	R/W	bit	DO-04_pulseSafeModeStatus	01:COIL STATUS	0: STOP, 1: START
0x01C5	00454	R/W	bit	DO-05_pulseSafeModeStatus	01:COIL STATUS	0: STOP, 1: START

Address (hex)	Register (decimal)	Access	Type	Parameter Name	Function Code	Description
0x01C6	00455	R/W	bit	DO-06_pulseSafeModeStatus	01:COIL STATUS	0: STOP, 1: START
0x01C7	00456	R/W	bit	DO-07_pulseSafeModeStatus	01:COIL STATUS	0: STOP, 1: START
0x0000	10001	R	bit	DI-00_status	02:INPUT STATUS	0: OFF, 1: ON
0x0001	10002	R	bit	DI-01_status	02:INPUT STATUS	0: OFF, 1: ON
0x0002	10003	R	bit	DI-02_status	02:INPUT STATUS	0: OFF, 1: ON
0x0003	10004	R	bit	DI-03_status	02:INPUT STATUS	0: OFF, 1: ON
0x0004	10005	R	bit	DI-04_status	02:INPUT STATUS	0: OFF, 1: ON
0x0005	10006	R	bit	DI-05_status	02:INPUT STATUS	0: OFF, 1: ON
0x0006	10007	R	bit	DI-06_status	02:INPUT STATUS	0: OFF, 1: ON
0x0007	10008	R	bit	DI-07_status	02:INPUT STATUS	0: OFF, 1: ON
0x0008	10009	R	bit	DI-08_status	02:INPUT STATUS	0: OFF, 1: ON
0x0009	10010	R	bit	DI-09_status	02:INPUT STATUS	0: OFF, 1: ON
0x000A	10011	R	bit	DI-10_status	02:INPUT STATUS	0: OFF, 1: ON
0x000B	10012	R	bit	DI-11_status	02:INPUT STATUS	0: OFF, 1: ON
0x000C	10013	R	bit	DI-12_status	02:INPUT STATUS	0: OFF, 1: ON
0x000D	10014	R	bit	DI-13_status	02:INPUT STATUS	0: OFF, 1: ON
0x000E	10015	R	bit	DI-14_status	02:INPUT STATUS	0: OFF, 1: ON
0x000F	10016	R	bit	DI-15_status	02:INPUT STATUS	0: OFF, 1: ON
0x2830	10289	R	bit	DIO-00_mode	02:INPUT STATUS	0: DI, 1: DO
0x2831	10290	R	bit	DIO-01_mode	02:INPUT STATUS	0: DI, 1: DO
0x2832	10291	R	bit	DIO-02_mode	02:INPUT STATUS	0: DI, 1: DO
0x2833	10292	R	bit	DIO-03_mode	02:INPUT STATUS	0: DI, 1: DO
0x2834	10293	R	bit	DIO-04_mode	02:INPUT STATUS	0: DI, 1: DO
0x2835	10294	R	bit	DIO-05_mode	02:INPUT STATUS	0: DI, 1: DO
0x2836	10295	R	bit	DIO-06_mode	02:INPUT STATUS	0: DI, 1: DO
0x2837	10296	R	bit	DIO-07_mode	02:INPUT STATUS	0: DI, 1: DO

Address (hex)	Register (decimal)	Access	Type	Parameter Name	Function Code	Description
0x0000	30001	R	word	DI-00_status	04:INPUT REGISTER	0: OFF, 1: ON
0x0001	30002	R	word	DI-01_status	04:INPUT REGISTER	0: OFF, 1: ON
0x0002	30003	R	word	DI-02_status	04:INPUT REGISTER	0: OFF, 1: ON
0x0003	30004	R	word	DI-03_status	04:INPUT REGISTER	0: OFF, 1: ON
0x0004	30005	R	word	DI-04_status	04:INPUT REGISTER	0: OFF, 1: ON
0x0005	30006	R	word	DI-05_status	04:INPUT REGISTER	0: OFF, 1: ON
0x0006	30007	R	word	DI-06_status	04:INPUT REGISTER	0: OFF, 1: ON
0x0007	30008	R	word	DI-07_status	04:INPUT REGISTER	0: OFF, 1: ON
0x0008	30009	R	word	DI-08_status	04:INPUT REGISTER	0: OFF, 1: ON
0x0009	30010	R	word	DI-09_status	04:INPUT REGISTER	0: OFF, 1: ON
0x000A	30011	R	word	DI-10_status	04:INPUT REGISTER	0: OFF, 1: ON
0x000B	30012	R	word	DI-11_status	04:INPUT REGISTER	0: OFF, 1: ON
0x000C	30013	R	word	DI-12_status	04:INPUT REGISTER	0: OFF, 1: ON
0x000D	30014	R	word	DI-13_status	04:INPUT REGISTER	0: OFF, 1: ON
0x000E	30015	R	word	DI-14_status	04:INPUT REGISTER	0: OFF, 1: ON
0x000F	30016	R	word	DI-15_status	04:INPUT REGISTER	0: OFF, 1: ON
0x0020	30033	R	word	DI-00_counterValueHigh	04:INPUT REGISTER	high word
0x0021	30034	R	word	DI-00_counterValueLow	04:INPUT REGISTER	low word
0x0022	30035	R	word	DI-01_counterValueHigh	04:INPUT REGISTER	high word
0x0023	30036	R	word	DI-01_counterValueLow	04:INPUT REGISTER	low word
0x0024	30037	R	word	DI-02_counterValueHigh	04:INPUT REGISTER	high word
0x0025	30038	R	word	DI-02_counterValueLow	04:INPUT REGISTER	low word
0x0026	30039	R	word	DI-03_counterValueHigh	04:INPUT REGISTER	high word
0x0027	30040	R	word	DI-03_counterValueLow	04:INPUT REGISTER	low word
0x0028	30041	R	word	DI-04_counterValueHigh	04:INPUT REGISTER	high word
0x0029	30042	R	word	DI-04_counterValueLow	04:INPUT REGISTER	low word

Address (hex)	Register (decimal)	Access	Type	Parameter Name	Function Code	Description
0x002A	30043	R	word	DI-05_counterValueHigh	04:INPUT REGISTER	high word
0x002B	30044	R	word	DI-05_counterValueLow	04:INPUT REGISTER	low word
0x002C	30045	R	word	DI-06_counterValueHigh	04:INPUT REGISTER	high word
0x002D	30046	R	word	DI-06_counterValueLow	04:INPUT REGISTER	low word
0x002E	30047	R	word	DI-07_counterValueHigh	04:INPUT REGISTER	high word
0x002F	30048	R	word	DI-07_counterValueLow	04:INPUT REGISTER	low word
0x0030	30049	R	word	DI-08_counterValueHigh	04:INPUT REGISTER	high word
0x0031	30050	R	word	DI-08_counterValueLow	04:INPUT REGISTER	low word
0x0032	30051	R	word	DI-09_counterValueHigh	04:INPUT REGISTER	high word
0x0033	30052	R	word	DI-09_counterValueLow	04:INPUT REGISTER	low word
0x0034	30053	R	word	DI-10_counterValueHigh	04:INPUT REGISTER	high word
0x0035	30054	R	word	DI-10_counterValueLow	04:INPUT REGISTER	low word
0x0036	30055	R	word	DI-11_counterValueHigh	04:INPUT REGISTER	high word
0x0037	30056	R	word	DI-11_counterValueLow	04:INPUT REGISTER	low word
0x0038	30057	R	word	DI-12_counterValueHigh	04:INPUT REGISTER	high word
0x0039	30058	R	word	DI-12_counterValueLow	04:INPUT REGISTER	low word
0x003A	30059	R	word	DI-13_counterValueHigh	04:INPUT REGISTER	high word
0x003B	30060	R	word	DI-13_counterValueLow	04:INPUT REGISTER	low word
0x003C	30061	R	word	DI-14_counterValueHigh	04:INPUT REGISTER	high word
0x003D	30062	R	word	DI-14_counterValueLow	04:INPUT REGISTER	low word
0x003E	30063	R	word	DI-15_counterValueHigh	04:INPUT REGISTER	high word
0x003F	30064	R	word	DI-15_counterValueLow	04:INPUT REGISTER	low word
0x0120	30289	R	word	DIO-00_mode	04:INPUT REGISTER	0: DI, 1: DO
0x0121	30290	R	word	DIO-01_mode	04:INPUT REGISTER	0: DI, 1: DO
0x0122	30291	R	word	DIO-02_mode	04:INPUT REGISTER	0: DI, 1: DO
0x0123	30292	R	word	DIO-03_mode	04:INPUT REGISTER	0: DI, 1: DO

Address (hex)	Register (decimal)	Access	Type	Parameter Name	Function Code	Description
0x0124	30293	R	word	DIO-04_mode	04:INPUT REGISTER	0: DI, 1: DO
0x0125	30294	R	word	DIO-05_mode	04:INPUT REGISTER	0: DI, 1: DO
0x0126	30295	R	word	DIO-06_mode	04:INPUT REGISTER	0: DI, 1: DO
0x0127	30296	R	word	DIO-07_mode	04:INPUT REGISTER	0: DI, 1: DO
0x0000	40001	R/W	word	DI-00_mode	03:HOLDING REGISTER	0: DI, 1: Counter
0x0001	40002	R/W	word	DI-01_mode	03:HOLDING REGISTER	0: DI, 1: Counter
0x0002	40003	R/W	word	DI-02_mode	03:HOLDING REGISTER	0: DI, 1: Counter
0x0003	40004	R/W	word	DI-03_mode	03:HOLDING REGISTER	0: DI, 1: Counter
0x0004	40005	R/W	word	DI-04_mode	03:HOLDING REGISTER	0: DI, 1: Counter
0x0005	40006	R/W	word	DI-05_mode	03:HOLDING REGISTER	0: DI, 1: Counter
0x0006	40007	R/W	word	DI-06_mode	03:HOLDING REGISTER	0: DI, 1: Counter
0x0007	40008	R/W	word	DI-07_mode	03:HOLDING REGISTER	0: DI, 1: Counter
0x0008	40009	R/W	word	DI-08_mode	03:HOLDING REGISTER	0: DI, 1: Counter
0x0009	40010	R/W	word	DI-09_mode	03:HOLDING REGISTER	0: DI, 1: Counter
0x000A	40011	R/W	word	DI-10_mode	03:HOLDING REGISTER	0: DI, 1: Counter
0x000B	40012	R/W	word	DI-11_mode	03:HOLDING REGISTER	0: DI, 1: Counter
0x000C	40013	R/W	word	DI-12_mode	03:HOLDING REGISTER	0: DI, 1: Counter
0x000D	40014	R/W	word	DI-13_mode	03:HOLDING REGISTER	0: DI, 1: Counter
0x000E	40015	R/W	word	DI-14_mode	03:HOLDING REGISTER	0: DI, 1: Counter
0x000F	40016	R/W	word	DI-15_mode	03:HOLDING REGISTER	0: DI, 1: Counter
0x0020	40033	R/W	word	DI-00_filter	03:HOLDING REGISTER	unit: 100 us
0x0021	40034	R/W	word	DI-01_filter	03:HOLDING REGISTER	unit: 100 us
0x0022	40035	R/W	word	DI-02_filter	03:HOLDING REGISTER	unit: 100 us
0x0023	40036	R/W	word	DI-03_filter	03:HOLDING REGISTER	unit: 100 us
0x0024	40037	R/W	word	DI-04_filter	03:HOLDING REGISTER	unit: 100 us
0x0025	40038	R/W	word	DI-05_filter	03:HOLDING REGISTER	unit: 100 us

Address (hex)	Register (decimal)	Access	Type	Parameter Name	Function Code	Description
0x0026	40039	R/W	word	DI-06_filter	03:HOLDIN G REGISTER	unit: 100 us
0x0027	40040	R/W	word	DI-07_filter	03:HOLDIN G REGISTER	unit: 100 us
0x0028	40041	R/W	word	DI-08_filter	03:HOLDIN G REGISTER	unit: 100 us
0x0029	40042	R/W	word	DI-09_filter	03:HOLDIN G REGISTER	unit: 100 us
0x002A	40043	R/W	word	DI-10_filter	03:HOLDIN G REGISTER	unit: 100 us
0x002B	40044	R/W	word	DI-11_filter	03:HOLDIN G REGISTER	unit: 100 us
0x002C	40045	R/W	word	DI-12_filter	03:HOLDIN G REGISTER	unit: 100 us
0x002D	40046	R/W	word	DI-13_filter	03:HOLDIN G REGISTER	unit: 100 us
0x002E	40047	R/W	word	DI-14_filter	03:HOLDIN G REGISTER	unit: 100 us
0x002F	40048	R/W	word	DI-15_filter	03:HOLDIN G REGISTER	unit: 100 us
0x0040	40065	R/W	word	DI-00_counterEvent	03:HOLDIN G REGISTER	0: Rising Edge, 1: Falling Edge, 2: Both
0x0041	40066	R/W	word	DI-01_counterEvent	03:HOLDIN G REGISTER	0: Rising Edge, 1: Falling Edge, 2: Both
0x0042	40067	R/W	word	DI-02_counterEvent	03:HOLDIN G REGISTER	0: Rising Edge, 1: Falling Edge, 2: Both
0x0043	40068	R/W	word	DI-03_counterEvent	03:HOLDIN G REGISTER	0: Rising Edge, 1: Falling Edge, 2: Both
0x0044	40069	R/W	word	DI-04_counterEvent	03:HOLDIN G REGISTER	0: Rising Edge, 1: Falling Edge, 2: Both
0x0045	40070	R/W	word	DI-05_counterEvent	03:HOLDIN G REGISTER	0: Rising Edge, 1: Falling Edge, 2: Both
0x0046	40071	R/W	word	DI-06_counterEvent	03:HOLDIN G REGISTER	0: Rising Edge, 1: Falling Edge, 2: Both
0x0047	40072	R/W	word	DI-07_counterEvent	03:HOLDIN G REGISTER	0: Rising Edge, 1: Falling Edge, 2: Both
0x0048	40073	R/W	word	DI-08_counterEvent	03:HOLDIN G REGISTER	0: Rising Edge, 1: Falling Edge, 2: Both
0x0049	40074	R/W	word	DI-09_counterEvent	03:HOLDIN G REGISTER	0: Rising Edge, 1: Falling Edge, 2: Both

Address (hex)	Register (decimal)	Access	Type	Parameter Name	Function Code	Description
0x004A	40075	R/W	word	DI-10_counterEvent	03:HOLDIN G REGISTER	0: Rising Edge, 1: Falling Edge, 2: Both
0x004B	40076	R/W	word	DI-11_counterEvent	03:HOLDIN G REGISTER	0: Rising Edge, 1: Falling Edge, 2: Both
0x004C	40077	R/W	word	DI-12_counterEvent	03:HOLDIN G REGISTER	0: Rising Edge, 1: Falling Edge, 2: Both
0x004D	40078	R/W	word	DI-13_counterEvent	03:HOLDIN G REGISTER	0: Rising Edge, 1: Falling Edge, 2: Both
0x004E	40079	R/W	word	DI-14_counterEvent	03:HOLDIN G REGISTER	0: Rising Edge, 1: Falling Edge, 2: Both
0x004F	40080	R/W	word	DI-15_counterEvent	03:HOLDIN G REGISTER	0: Rising Edge, 1: Falling Edge, 2: Both
0x0140	40321	R/W	word	DO-00_status	03:HOLDIN G REGISTER	0: OFF, 1: ON
0x0141	40322	R/W	word	DO-01_status	03:HOLDIN G REGISTER	0: OFF, 1: ON
0x0142	40323	R/W	word	DO-02_status	03:HOLDIN G REGISTER	0: OFF, 1: ON
0x0143	40324	R/W	word	DO-03_status	03:HOLDIN G REGISTER	0: OFF, 1: ON
0x0144	40325	R/W	word	DO-04_status	03:HOLDIN G REGISTER	0: OFF, 1: ON
0x0145	40326	R/W	word	DO-05_status	03:HOLDIN G REGISTER	0: OFF, 1: ON
0x0146	40327	R/W	word	DO-06_status	03:HOLDIN G REGISTER	0: OFF, 1: ON
0x0147	40328	R/W	word	DO-07_status	03:HOLDIN G REGISTER	0: OFF, 1: ON
0x0160	40353	R/W	word	DO-00_pulseCountHigh	03:HOLDIN G REGISTER	high word
0x0161	40354	R/W	word	DO-00_pulseCountLow	03:HOLDIN G REGISTER	low word
0x0162	40355	R/W	word	DO-01_pulseCountHigh	03:HOLDIN G REGISTER	high word
0x0163	40356	R/W	word	DO-01_pulseCountLow	03:HOLDIN G REGISTER	low word
0x0164	40357	R/W	word	DO-02_pulseCountHigh	03:HOLDIN G REGISTER	high word
0x0165	40358	R/W	word	DO-02_pulseCountLow	03:HOLDIN G REGISTER	low word
0x0166	40359	R/W	word	DO-03_pulseCountHigh	03:HOLDIN G REGISTER	high word
0x0167	40360	R/W	word	DO-03_pulseCountLow	03:HOLDIN G REGISTER	low word
0x0168	40361	R/W	word	DO-04_pulseCountHigh	03:HOLDIN G REGISTER	high word

Address (hex)	Register (decimal)	Access	Type	Parameter Name	Function Code	Description
0x0169	40362	R/W	word	DO-04_pulseCountLow	03:HOLDIN G REGISTER	low word
0x016A	40363	R/W	word	DO-05_pulseCountHigh	03:HOLDIN G REGISTER	high word
0x016B	40364	R/W	word	DO-05_pulseCountLow	03:HOLDIN G REGISTER	low word
0x016C	40365	R/W	word	DO-06_pulseCountHigh	03:HOLDIN G REGISTER	high word
0x016D	40366	R/W	word	DO-06_pulseCountLow	03:HOLDIN G REGISTER	low word
0x016E	40367	R/W	word	DO-07_pulseCountHigh	03:HOLDIN G REGISTER	high word
0x016F	40368	R/W	word	DO-07_pulseCountLow	03:HOLDIN G REGISTER	low word
0x01A0	40417	R/W	word	DO-00_pulseOnWidth	03:HOLDIN G REGISTER	unit: 1 ms
0x01A1	40418	R/W	word	DO-01_pulseOnWidth	03:HOLDIN G REGISTER	unit: 1 ms
0x01A2	40419	R/W	word	DO-02_pulseOnWidth	03:HOLDIN G REGISTER	unit: 1 ms
0x01A3	40420	R/W	word	DO-03_pulseOnWidth	03:HOLDIN G REGISTER	unit: 1 ms
0x01A4	40421	R/W	word	DO-04_pulseOnWidth	03:HOLDIN G REGISTER	unit: 1 ms
0x01A5	40422	R/W	word	DO-05_pulseOnWidth	03:HOLDIN G REGISTER	unit: 1 ms
0x01A6	40423	R/W	word	DO-06_pulseOnWidth	03:HOLDIN G REGISTER	unit: 1 ms
0x01A7	40424	R/W	word	DO-07_pulseOnWidth	03:HOLDIN G REGISTER	unit: 1 ms
0x01C0	40449	R/W	word	DO-00_pulseOffWidth	03:HOLDIN G REGISTER	unit: 1 ms
0x01C1	40450	R/W	word	DO-01_pulseOffWidth	03:HOLDIN G REGISTER	unit: 1 ms
0x01C2	40451	R/W	word	DO-02_pulseOffWidth	03:HOLDIN G REGISTER	unit: 1 ms
0x01C3	40452	R/W	word	DO-03_pulseOffWidth	03:HOLDIN G REGISTER	unit: 1 ms
0x01C4	40453	R/W	word	DO-04_pulseOffWidth	03:HOLDIN G REGISTER	unit: 1 ms
0x01C5	40454	R/W	word	DO-05_pulseOffWidth	03:HOLDIN G REGISTER	unit: 1 ms
0x01C6	40455	R/W	word	DO-06_pulseOffWidth	03:HOLDIN G REGISTER	unit: 1 ms
0x01C7	40456	R/W	word	DO-07_pulseOffWidth	03:HOLDIN G REGISTER	unit: 1 ms
0x01E0	40481	R/W	word	DO-00_safeModeStatus	03:HOLDIN G REGISTER	0: OFF, 1: ON, 2: Hold Last
0x01E1	40482	R/W	word	DO-01_safeModeStatus	03:HOLDIN G REGISTER	0: OFF, 1: ON, 2: Hold Last
0x01E2	40483	R/W	word	DO-02_safeModeStatus	03:HOLDIN G REGISTER	0: OFF, 1: ON, 2: Hold Last

Address (hex)	Register (decimal)	Access	Type	Parameter Name	Function Code	Description
0x01E3	40484	R/W	word	DO-03_safeModeStatus	03:HOLDIN G REGISTER	0: OFF, 1: ON, 2: Hold Last
0x01E4	40485	R/W	word	DO-04_safeModeStatus	03:HOLDIN G REGISTER	0: OFF, 1: ON, 2: Hold Last
0x01E5	40486	R/W	word	DO-05_safeModeStatus	03:HOLDIN G REGISTER	0: OFF, 1: ON, 2: Hold Last
0x01E6	40487	R/W	word	DO-06_safeModeStatus	03:HOLDIN G REGISTER	0: OFF, 1: ON, 2: Hold Last
0x01E7	40488	R/W	word	DO-07_safeModeStatus	03:HOLDIN G REGISTER	0: OFF, 1: ON, 2: Hold Last
0x0200	40513	R/W	word	DO-00_mode	03:HOLDIN G REGISTER	0: DO, 1: Pulse
0x0201	40514	R/W	word	DO-01_mode	03:HOLDIN G REGISTER	0: DO, 1: Pulse
0x0202	40515	R/W	word	DO-02_mode	03:HOLDIN G REGISTER	0: DO, 1: Pulse
0x0203	40516	R/W	word	DO-03_mode	03:HOLDIN G REGISTER	0: DO, 1: Pulse
0x0204	40517	R/W	word	DO-04_mode	03:HOLDIN G REGISTER	0: DO, 1: Pulse
0x0205	40518	R/W	word	DO-05_mode	03:HOLDIN G REGISTER	0: DO, 1: Pulse
0x0206	40519	R/W	word	DO-06_mode	03:HOLDIN G REGISTER	0: DO, 1: Pulse
0x0207	40520	R/W	word	DO-07_mode	03:HOLDIN G REGISTER	0: DO, 1: Pulse

ioLogik R1214 Modbus Address and Register Map

Address (hex)	Register (decimal)	Access	Type	Parameter Name	Function Code	Description
0x0000	00001	R/W	bit	DI-00_counterStatus	01:COIL STATUS	0: STOP, 1: START
0x0001	00002	R/W	bit	DI-01_counterStatus	01:COIL STATUS	0: STOP, 1: START
0x0002	00003	R/W	bit	DI-02_counterStatus	01:COIL STATUS	0: STOP, 1: START
0x0003	00004	R/W	bit	DI-03_counterStatus	01:COIL STATUS	0: STOP, 1: START
0x0004	00005	R/W	bit	DI-04_counterStatus	01:COIL STATUS	0: STOP, 1: START
0x0005	00006	R/W	bit	DI-05_counterStatus	01:COIL STATUS	0: STOP, 1: START
0x0020	00033	R/W	bit	DI-00_counterReset	01:COIL STATUS	1: reset to initial value
0x0021	00034	R/W	bit	DI-01_counterReset	01:COIL STATUS	1: reset to initial value
0x0022	00035	R/W	bit	DI-02_counterReset	01:COIL STATUS	1: reset to initial value

Address (hex)	Register (decimal)	Access	Type	Parameter Name	Function Code	Description
0x0023	00036	R/W	bit	DI-03_counterReset	01:COIL STATUS	1: reset to initial value
0x0024	00037	R/W	bit	DI-04_counterReset	01:COIL STATUS	1: reset to initial value
0x0025	00038	R/W	bit	DI-05_counterReset	01:COIL STATUS	1: reset to initial value
0x0040	00065	R/W	bit	DI-00_counterOverflowFlag	01:COIL STATUS	1: clear overflow flag
0x0041	00066	R/W	bit	DI-01_counterOverflowFlag	01:COIL STATUS	1: clear overflow flag
0x0042	00067	R/W	bit	DI-02_counterOverflowFlag	01:COIL STATUS	1: clear overflow flag
0x0043	00068	R/W	bit	DI-03_counterOverflowFlag	01:COIL STATUS	1: clear overflow flag
0x0044	00069	R/W	bit	DI-04_counterOverflowFlag	01:COIL STATUS	1: clear overflow flag
0x0045	00070	R/W	bit	DI-05_counterOverflowFlag	01:COIL STATUS	1: clear overflow flag
0x0060	00097	R/W	bit	DI-00_counterPowerOnStatus	01:COIL STATUS	0: STOP, 1: START
0x0061	00098	R/W	bit	DI-01_counterPowerOnStatus	01:COIL STATUS	0: STOP, 1: START
0x0062	00099	R/W	bit	DI-02_counterPowerOnStatus	01:COIL STATUS	0: STOP, 1: START
0x0063	00100	R/W	bit	DI-03_counterPowerOnStatus	01:COIL STATUS	0: STOP, 1: START
0x0064	00101	R/W	bit	DI-04_counterPowerOnStatus	01:COIL STATUS	0: STOP, 1: START
0x0065	00102	R/W	bit	DI-05_counterPowerOnStatus	01:COIL STATUS	0: STOP, 1: START
0x0080	00129	R/W	bit	DI-00_counterSafeModeStatus	01:COIL STATUS	0: STOP, 1: START
0x0081	00130	R/W	bit	DI-01_counterSafeModeStatus	01:COIL STATUS	0: STOP, 1: START
0x0082	00131	R/W	bit	DI-02_counterSafeModeStatus	01:COIL STATUS	0: STOP, 1: START
0x0083	00132	R/W	bit	DI-03_counterSafeModeStatus	01:COIL STATUS	0: STOP, 1: START
0x0084	00133	R/W	bit	DI-04_counterSafeModeStatus	01:COIL STATUS	0: STOP, 1: START
0x0085	00134	R/W	bit	DI-05_counterSafeModeStatus	01:COIL STATUS	0: STOP, 1: START
0x00A0	00161	R/W	bit	DI-00_counterPowerOffStorage	01:COIL STATUS	0: Disable, 1: Enable
0x00A1	00162	R/W	bit	DI-01_counterPowerOffStorage	01:COIL STATUS	0: Disable, 1: Enable
0x00A2	00163	R/W	bit	DI-02_counterPowerOffStorage	01:COIL STATUS	0: Disable, 1: Enable
0x00A3	00164	R/W	bit	DI-03_counterPowerOffStorage	01:COIL STATUS	0: Disable, 1: Enable
0x00A4	00165	R/W	bit	DI-04_counterPowerOffStorage	01:COIL STATUS	0: Disable, 1: Enable

Address (hex)	Register (decimal)	Access	Type	Parameter Name	Function Code	Description
0x00A5	00166	R/W	bit	DI-05_counterPowerOffStorage	01:COIL STATUS	0: Disable, 1: Enable
0x0140	00321	R/W	bit	RLY-00_status	01:COIL STATUS	0: OFF, 1: ON
0x0141	00322	R/W	bit	RLY-01_status	01:COIL STATUS	0: OFF, 1: ON
0x0142	00323	R/W	bit	RLY-02_status	01:COIL STATUS	0: OFF, 1: ON
0x0143	00324	R/W	bit	RLY-03_status	01:COIL STATUS	0: OFF, 1: ON
0x0144	00325	R/W	bit	RLY-04_status	01:COIL STATUS	0: OFF, 1: ON
0x0145	00326	R/W	bit	RLY-05_status	01:COIL STATUS	0: OFF, 1: ON
0x0160	00353	R/W	bit	RLY-00_powerOnStatus	01:COIL STATUS	0: OFF, 1: ON
0x0161	00354	R/W	bit	RLY-01_powerOnStatus	01:COIL STATUS	0: OFF, 1: ON
0x0162	00355	R/W	bit	RLY-02_powerOnStatus	01:COIL STATUS	0: OFF, 1: ON
0x0163	00356	R/W	bit	RLY-03_powerOnStatus	01:COIL STATUS	0: OFF, 1: ON
0x0164	00357	R/W	bit	RLY-04_powerOnStatus	01:COIL STATUS	0: OFF, 1: ON
0x0165	00358	R/W	bit	RLY-05_powerOnStatus	01:COIL STATUS	0: OFF, 1: ON
0x0180	00385	R/W	bit	RLY-00_pulseStatus	01:COIL STATUS	0: STOP, 1: START
0x0181	00386	R/W	bit	RLY-01_pulseStatus	01:COIL STATUS	0: STOP, 1: START
0x0182	00387	R/W	bit	RLY-02_pulseStatus	01:COIL STATUS	0: STOP, 1: START
0x0183	00388	R/W	bit	RLY-03_pulseStatus	01:COIL STATUS	0: STOP, 1: START
0x0184	00389	R/W	bit	RLY-04_pulseStatus	01:COIL STATUS	0: STOP, 1: START
0x0185	00390	R/W	bit	RLY-05_pulseStatus	01:COIL STATUS	0: STOP, 1: START
0x01A0	00417	R/W	bit	RLY-00_pulsePowerOnStatus	01:COIL STATUS	0: STOP, 1: START
0x01A1	00418	R/W	bit	RLY-01_pulsePowerOnStatus	01:COIL STATUS	0: STOP, 1: START
0x01A2	00419	R/W	bit	RLY-02_pulsePowerOnStatus	01:COIL STATUS	0: STOP, 1: START
0x01A3	00420	R/W	bit	RLY-03_pulsePowerOnStatus	01:COIL STATUS	0: STOP, 1: START
0x01A4	00421	R/W	bit	RLY-04_pulsePowerOnStatus	01:COIL STATUS	0: STOP, 1: START
0x01A5	00422	R/W	bit	RLY-05_pulsePowerOnStatus	01:COIL STATUS	0: STOP, 1: START
0x01C0	00449	R/W	bit	RLY-00_pulseSafeModeStatus	01:COIL STATUS	0: STOP, 1: START

Address (hex)	Register (decimal)	Access	Type	Parameter Name	Function Code	Description
0x01C1	00450	R/W	bit	RLY-01_pulseSafeModeStatus	01:COIL STATUS	0: STOP, 1: START
0x01C2	00451	R/W	bit	RLY-02_pulseSafeModeStatus	01:COIL STATUS	0: STOP, 1: START
0x01C3	00452	R/W	bit	RLY-03_pulseSafeModeStatus	01:COIL STATUS	0: STOP, 1: START
0x01C4	00453	R/W	bit	RLY-04_pulseSafeModeStatus	01:COIL STATUS	0: STOP, 1: START
0x01C5	00454	R/W	bit	RLY-05_pulseSafeModeStatus	01:COIL STATUS	0: STOP, 1: START
0x01DF	00480	R/W	bit	RLY-00_pulseReset	01:COIL STATUS	1: reset pulse count
0x01E0	00481	R/W	bit	RLY-01_pulseReset	01:COIL STATUS	1: reset pulse count
0x01E1	00482	R/W	bit	RLY-02_pulseReset	01:COIL STATUS	1: reset pulse count
0x01E2	00483	R/W	bit	RLY-03_pulseReset	01:COIL STATUS	1: reset pulse count
0x01E3	00484	R/W	bit	RLY-04_pulseReset	01:COIL STATUS	1: reset pulse count
0x01E4	00485	R/W	bit	RLY-05_pulseReset	01:COIL STATUS	1: reset pulse count
0x0000	10001	R	bit	DI-00_status	02:INPUT STATUS	0: OFF, 1: ON
0x0001	10002	R	bit	DI-01_status	02:INPUT STATUS	0: OFF, 1: ON
0x0002	10003	R	bit	DI-02_status	02:INPUT STATUS	0: OFF, 1: ON
0x0003	10004	R	bit	DI-03_status	02:INPUT STATUS	0: OFF, 1: ON
0x0004	10005	R	bit	DI-04_status	02:INPUT STATUS	0: OFF, 1: ON
0x0005	10006	R	bit	DI-05_status	02:INPUT STATUS	0: OFF, 1: ON
0x0000	30001	R	word	DI-00_status	04:INPUT REGISTER	0: OFF, 1: ON
0x0001	30002	R	word	DI-01_status	04:INPUT REGISTER	0: OFF, 1: ON
0x0002	30003	R	word	DI-02_status	04:INPUT REGISTER	0: OFF, 1: ON
0x0003	30004	R	word	DI-03_status	04:INPUT REGISTER	0: OFF, 1: ON
0x0004	30005	R	word	DI-04_status	04:INPUT REGISTER	0: OFF, 1: ON
0x0005	30006	R	word	DI-05_status	04:INPUT REGISTER	0: OFF, 1: ON
0x0020	30033	R	word	DI-00_counterValueHigh	04:INPUT REGISTER	high word
0x0021	30034	R	word	DI-00_counterValueLow	04:INPUT REGISTER	low word
0x0022	30035	R	word	DI-01_counterValueHigh	04:INPUT REGISTER	high word

Address (hex)	Register (decimal)	Access	Type	Parameter Name	Function Code	Description
0x0023	30036	R	word	DI-01_counterValueLow	04:INPUT REGISTER	low word
0x0024	30037	R	word	DI-02_counterValueHigh	04:INPUT REGISTER	high word
0x0025	30038	R	word	DI-02_counterValueLow	04:INPUT REGISTER	low word
0x0026	30039	R	word	DI-03_counterValueHigh	04:INPUT REGISTER	high word
0x0027	30040	R	word	DI-03_counterValueLow	04:INPUT REGISTER	low word
0x0028	30041	R	word	DI-04_counterValueHigh	04:INPUT REGISTER	high word
0x0029	30042	R	word	DI-04_counterValueLow	04:INPUT REGISTER	low word
0x002A	30043	R	word	DI-05_counterValueHigh	04:INPUT REGISTER	high word
0x002B	30044	R	word	DI-05_counterValueLow	04:INPUT REGISTER	low word
0x0140	30321	R	word	RLY-00_totalCountHigh	04:INPUT REGISTER	high word
0x0141	30322	R	word	RLY-00_totalCountLow	04:INPUT REGISTER	low word
0x0142	30323	R	word	RLY-01_totalCountHigh	04:INPUT REGISTER	high word
0x0143	30324	R	word	RLY-01_totalCountLow	04:INPUT REGISTER	low word
0x0144	30325	R	word	RLY-02_totalCountHigh	04:INPUT REGISTER	high word
0x0145	30326	R	word	RLY-02_totalCountLow	04:INPUT REGISTER	low word
0x0146	30327	R	word	RLY-03_totalCountHigh	04:INPUT REGISTER	high word
0x0147	30328	R	word	RLY-03_totalCountLow	04:INPUT REGISTER	low word
0x0148	30329	R	word	RLY-04_totalCountHigh	04:INPUT REGISTER	high word
0x0149	30330	R	word	RLY-04_totalCountLow	04:INPUT REGISTER	low word
0x014A	30331	R	word	RLY-05_totalCountHigh	04:INPUT REGISTER	high word
0x014B	30332	R	word	RLY-05_totalCountLow	04:INPUT REGISTER	low word
0x0180	30385	R	word	RLY-00_currentCountHigh	04:INPUT REGISTER	high word
0x0181	30386	R	word	RLY-00_currentCountLow	04:INPUT REGISTER	low word
0x0182	30387	R	word	RLY-01_currentCountHigh	04:INPUT REGISTER	high word
0x0183	30388	R	word	RLY-01_currentCountLow	04:INPUT REGISTER	low word
0x0184	30389	R	word	RLY-02_currentCountHigh	04:INPUT REGISTER	high word

Address (hex)	Register (decimal)	Access	Type	Parameter Name	Function Code	Description
0x0185	30390	R	word	RLY-02_currentCountLow	04:INPUT REGISTER	low word
0x0186	30391	R	word	RLY-03_currentCountHigh	04:INPUT REGISTER	high word
0x0187	30392	R	word	RLY-03_currentCountLow	04:INPUT REGISTER	low word
0x0188	30393	R	word	RLY-04_currentCountHigh	04:INPUT REGISTER	high word
0x0189	30394	R	word	RLY-04_currentCountLow	04:INPUT REGISTER	low word
0x018A	30395	R	word	RLY-05_currentCountHigh	04:INPUT REGISTER	high word
0x018B	30396	R	word	RLY-05_currentCountLow	04:INPUT REGISTER	low word
0x0000	40001	R/W	word	DI-00_mode	03:HOLDING REGISTER	0: DI, 1: Counter
0x0001	40002	R/W	word	DI-01_mode	03:HOLDING REGISTER	0: DI, 1: Counter
0x0002	40003	R/W	word	DI-02_mode	03:HOLDING REGISTER	0: DI, 1: Counter
0x0003	40004	R/W	word	DI-03_mode	03:HOLDING REGISTER	0: DI, 1: Counter
0x0004	40005	R/W	word	DI-04_mode	03:HOLDING REGISTER	0: DI, 1: Counter
0x0005	40006	R/W	word	DI-05_mode	03:HOLDING REGISTER	0: DI, 1: Counter
0x0020	40033	R/W	word	DI-00_filter	03:HOLDING REGISTER	unit: 100 us
0x0021	40034	R/W	word	DI-01_filter	03:HOLDING REGISTER	unit: 100 us
0x0022	40035	R/W	word	DI-02_filter	03:HOLDING REGISTER	unit: 100 us
0x0023	40036	R/W	word	DI-03_filter	03:HOLDING REGISTER	unit: 100 us
0x0024	40037	R/W	word	DI-04_filter	03:HOLDING REGISTER	unit: 100 us
0x0025	40038	R/W	word	DI-05_filter	03:HOLDING REGISTER	unit: 100 us
0x0040	40065	R/W	word	DI-00_counterEvent	03:HOLDING REGISTER	0: Rising Edge, 1: Falling Edge, 2: Both
0x0041	40066	R/W	word	DI-01_counterEvent	03:HOLDING REGISTER	0: Rising Edge, 1: Falling Edge, 2: Both
0x0042	40067	R/W	word	DI-02_counterEvent	03:HOLDING REGISTER	0: Rising Edge, 1: Falling Edge, 2: Both
0x0043	40068	R/W	word	DI-03_counterEvent	03:HOLDING REGISTER	0: Rising Edge, 1: Falling Edge, 2: Both

Address (hex)	Register (decimal)	Access	Type	Parameter Name	Function Code	Description
0x0044	40069	R/W	word	DI-04_counterEvent	03:HOLDING REGISTER	0: Rising Edge, 1: Falling Edge, 2: Both
0x0045	40070	R/W	word	DI-05_counterEvent	03:HOLDING REGISTER	0: Rising Edge, 1: Falling Edge, 2: Both
0x0140	40321	R/W	word	RLY-00_status	03:HOLDING REGISTER	0: OFF, 1: ON
0x0141	40322	R/W	word	RLY-01_status	03:HOLDING REGISTER	0: OFF, 1: ON
0x0142	40323	R/W	word	RLY-02_status	03:HOLDING REGISTER	0: OFF, 1: ON
0x0143	40324	R/W	word	RLY-03_status	03:HOLDING REGISTER	0: OFF, 1: ON
0x0144	40325	R/W	word	RLY-04_status	03:HOLDING REGISTER	0: OFF, 1: ON
0x0145	40326	R/W	word	RLY-05_status	03:HOLDING REGISTER	0: OFF, 1: ON
0x0160	40353	R/W	word	RLY-00_pulseCountHigh	03:HOLDING REGISTER	high word
0x0161	40354	R/W	word	RLY-00_pulseCountLow	03:HOLDING REGISTER	low word
0x0162	40355	R/W	word	RLY-01_pulseCountHigh	03:HOLDING REGISTER	high word
0x0163	40356	R/W	word	RLY-01_pulseCountLow	03:HOLDING REGISTER	low word
0x0164	40357	R/W	word	RLY-02_pulseCountHigh	03:HOLDING REGISTER	high word
0x0165	40358	R/W	word	RLY-02_pulseCountLow	03:HOLDING REGISTER	low word
0x0166	40359	R/W	word	RLY-03_pulseCountHigh	03:HOLDING REGISTER	high word
0x0167	40360	R/W	word	RLY-03_pulseCountLow	03:HOLDING REGISTER	low word
0x0168	40361	R/W	word	RLY-04_pulseCountHigh	03:HOLDING REGISTER	high word
0x0169	40362	R/W	word	RLY-04_pulseCountLow	03:HOLDING REGISTER	low word
0x016A	40363	R/W	word	RLY-05_pulseCountHigh	03:HOLDING REGISTER	high word
0x016B	40364	R/W	word	RLY-05_pulseCountLow	03:HOLDING REGISTER	low word
0x01E0	40481	R/W	word	RLY-00_safeModeStatus	03:HOLDING REGISTER	0: OFF, 1: ON, 2: Hold Last
0x01E1	40482	R/W	word	RLY-01_safeModeStatus	03:HOLDING REGISTER	0: OFF, 1: ON, 2: Hold Last
0x01E2	40483	R/W	word	RLY-02_safeModeStatus	03:HOLDING REGISTER	0: OFF, 1: ON, 2: Hold Last
0x01E3	40484	R/W	word	RLY-03_safeModeStatus	03:HOLDING REGISTER	0: OFF, 1: ON, 2: Hold Last
0x01E4	40485	R/W	word	RLY-04_safeModeStatus	03:HOLDING REGISTER	0: OFF, 1: ON, 2: Hold Last

Address (hex)	Register (decimal)	Access	Type	Parameter Name	Function Code	Description
0x01E5	40486	R/W	word	RLY-05_safeModeStatus	03:HOLDING REGISTER	0: OFF, 1: ON, 2: Hold Last
0x01E6	40487	R/W	word	RLY-06_safeModeStatus	03:HOLDING REGISTER	0: OFF, 1: ON, 2: Hold Last
0x01E7	40488	R/W	word	RLY-07_safeModeStatus	03:HOLDING REGISTER	0: OFF, 1: ON, 2: Hold Last
0x0220	40545	R/W	word	RLY-00_PowerOnDelay	03:HOLDING REGISTER	unit: sec(s)
0x0221	40546	R/W	word	RLY-01_PowerOnDelay	03:HOLDING REGISTER	unit: sec(s)
0x0222	40547	R/W	word	RLY-02_PowerOnDelay	03:HOLDING REGISTER	unit: sec(s)
0x0223	40548	R/W	word	RLY-03_PowerOnDelay	03:HOLDING REGISTER	unit: sec(s)
0x0224	40549	R/W	word	RLY-04_PowerOnDelay	03:HOLDING REGISTER	unit: sec(s)
0x0225	40550	R/W	word	RLY-05_PowerOnDelay	03:HOLDING REGISTER	unit: sec(s)

ioLogik R1240 Modbus Address and Register Map

Address (hex)	Register (decimal)	Access	Type	Parameter Name	Function Code	Description
0x02C0	00705	R/W	bit	AI-00_resetMinValue	01:COIL STATUS	1: reset min. value
0x02C1	00706	R/W	bit	AI-01_resetMinValue	01:COIL STATUS	1: reset min. value
0x02C2	00707	R/W	bit	AI-02_resetMinValue	01:COIL STATUS	1: reset min. value
0x02C3	00708	R/W	bit	AI-03_resetMinValue	01:COIL STATUS	1: reset min. value
0x02C4	00709	R/W	bit	AI-04_resetMinValue	01:COIL STATUS	1: reset min. value
0x02C5	00710	R/W	bit	AI-05_resetMinValue	01:COIL STATUS	1: reset min. value
0x02C6	00711	R/W	bit	AI-06_resetMinValue	01:COIL STATUS	1: reset min. value
0x02C7	00712	R/W	bit	AI-07_resetMinValue	01:COIL STATUS	1: reset min. value
0x02E0	00737	R/W	bit	AI-00_resetMaxValue	01:COIL STATUS	1: reset max. value
0x02E1	00738	R/W	bit	AI-01_resetMaxValue	01:COIL STATUS	1: reset max. value
0x02E2	00739	R/W	bit	AI-02_resetMaxValue	01:COIL STATUS	1: reset max. value
0x02E3	00740	R/W	bit	AI-03_resetMaxValue	01:COIL STATUS	1: reset max. value
0x02E4	00741	R/W	bit	AI-04_resetMaxValue	01:COIL STATUS	1: reset max. value

Address (hex)	Register (decimal)	Access	Type	Parameter Name	Function Code	Description
0x02E5	00742	R/W	bit	AI-05_resetMaxValue	01:COIL STATUS	1: reset max. value
0x02E6	00743	R/W	bit	AI-06_resetMaxValue	01:COIL STATUS	1: reset max. value
0x02E7	00744	R/W	bit	AI-07_resetMaxValue	01:COIL STATUS	1: reset max. value
0x02C0	30705	R	word	AI-00_rawValue	04:INPUT REGISTER	
0x02C1	30706	R	word	AI-01_rawValue	04:INPUT REGISTER	
0x02C2	30707	R	word	AI-02_rawValue	04:INPUT REGISTER	
0x02C3	30708	R	word	AI-03_rawValue	04:INPUT REGISTER	
0x02C4	30709	R	word	AI-04_rawValue	04:INPUT REGISTER	
0x02C5	30710	R	word	AI-05_rawValue	04:INPUT REGISTER	
0x02C6	30711	R	word	AI-06_rawValue	04:INPUT REGISTER	
0x02C7	30712	R	word	AI-07_rawValue	04:INPUT REGISTER	
0x02E0	30737	R	word	AI-00_rawValueMin	04:INPUT REGISTER	
0x02E1	30738	R	word	AI-01_rawValueMin	04:INPUT REGISTER	
0x02E2	30739	R	word	AI-02_rawValueMin	04:INPUT REGISTER	
0x02E3	30740	R	word	AI-03_rawValueMin	04:INPUT REGISTER	
0x02E4	30741	R	word	AI-04_rawValueMin	04:INPUT REGISTER	
0x02E5	30742	R	word	AI-05_rawValueMin	04:INPUT REGISTER	
0x02E6	30743	R	word	AI-06_rawValueMin	04:INPUT REGISTER	
0x02E7	30744	R	word	AI-07_rawValueMin	04:INPUT REGISTER	
0x0300	30769	R	word	AI-00_rawValueMax	04:INPUT REGISTER	
0x0301	30770	R	word	AI-01_rawValueMax	04:INPUT REGISTER	
0x0302	30771	R	word	AI-02_rawValueMax	04:INPUT REGISTER	
0x0303	30772	R	word	AI-03_rawValueMax	04:INPUT REGISTER	
0x0304	30773	R	word	AI-04_rawValueMax	04:INPUT REGISTER	
0x0305	30774	R	word	AI-05_rawValueMax	04:INPUT REGISTER	
0x0306	30775	R	word	AI-06_rawValueMax	04:INPUT REGISTER	

Address (hex)	Register (decimal)	Access	Type	Parameter Name	Function Code	Description
0x0307	30776	R	word	AI-07_rawValueMax	04:INPUT REGISTER	
0x0320	30801	R	word	AI-00_engineeringValueHigh	04:INPUT REGISTER	high word
0x0321	30802	R	word	AI-00_engineeringValueLow	04:INPUT REGISTER	low word
0x0322	30803	R	word	AI-01_engineeringValueHigh	04:INPUT REGISTER	high word
0x0323	30804	R	word	AI-01_engineeringValueLow	04:INPUT REGISTER	low word
0x0324	30805	R	word	AI-02_engineeringValueHigh	04:INPUT REGISTER	high word
0x0325	30806	R	word	AI-02_engineeringValueLow	04:INPUT REGISTER	low word
0x0326	30807	R	word	AI-03_engineeringValueHigh	04:INPUT REGISTER	high word
0x0327	30808	R	word	AI-03_engineeringValueLow	04:INPUT REGISTER	low word
0x0328	30809	R	word	AI-04_engineeringValueHigh	04:INPUT REGISTER	high word
0x0329	30810	R	word	AI-04_engineeringValueLow	04:INPUT REGISTER	low word
0x032A	30811	R	word	AI-05_engineeringValueHigh	04:INPUT REGISTER	high word
0x032B	30812	R	word	AI-05_engineeringValueLow	04:INPUT REGISTER	low word
0x032C	30813	R	word	AI-06_engineeringValueHigh	04:INPUT REGISTER	high word
0x032D	30814	R	word	AI-06_engineeringValueLow	04:INPUT REGISTER	low word
0x032E	30815	R	word	AI-07_engineeringValueHigh	04:INPUT REGISTER	high word
0x032F	30816	R	word	AI-07_engineeringValueLow	04:INPUT REGISTER	low word
0x0360	30865	R	word	AI-00_engineeringValueMinHigh	04:INPUT REGISTER	high word
0x0361	30866	R	word	AI-00_engineeringValueMinLow	04:INPUT REGISTER	low word
0x0362	30867	R	word	AI-01_engineeringValueMinHigh	04:INPUT REGISTER	high word
0x0363	30868	R	word	AI-01_engineeringValueMinLow	04:INPUT REGISTER	low word
0x0364	30869	R	word	AI-02_engineeringValueMinHigh	04:INPUT REGISTER	high word
0x0365	30870	R	word	AI-02_engineeringValueMinLow	04:INPUT REGISTER	low word
0x0366	30871	R	word	AI-03_engineeringValueMinHigh	04:INPUT REGISTER	high word
0x0367	30872	R	word	AI-03_engineeringValueMinLow	04:INPUT REGISTER	low word
0x0368	30873	R	word	AI-04_engineeringValueMinHigh	04:INPUT REGISTER	high word

Address (hex)	Register (decimal)	Access	Type	Parameter Name	Function Code	Description
0x0369	30874	R	word	AI-04_engineeringValueMinLow	04:INPUT REGISTER	low word
0x036A	30875	R	word	AI-05_engineeringValueMinHigh	04:INPUT REGISTER	high word
0x036B	30876	R	word	AI-05_engineeringValueMinLow	04:INPUT REGISTER	low word
0x036C	30877	R	word	AI-06_engineeringValueMinHigh	04:INPUT REGISTER	high word
0x036D	30878	R	word	AI-06_engineeringValueMinLow	04:INPUT REGISTER	low word
0x036E	30879	R	word	AI-07_engineeringValueMinHigh	04:INPUT REGISTER	high word
0x036F	30880	R	word	AI-07_engineeringValueMinLow	04:INPUT REGISTER	low word
0x03A0	30929	R	word	AI-00_engineeringValueMaxHigh	04:INPUT REGISTER	high word
0x03A1	30930	R	word	AI-00_engineeringValueMaxLow	04:INPUT REGISTER	low word
0x03A2	30931	R	word	AI-01_engineeringValueMaxHigh	04:INPUT REGISTER	high word
0x03A3	30932	R	word	AI-01_engineeringValueMaxLow	04:INPUT REGISTER	low word
0x03A4	30933	R	word	AI-02_engineeringValueMaxHigh	04:INPUT REGISTER	high word
0x03A5	30934	R	word	AI-02_engineeringValueMaxLow	04:INPUT REGISTER	low word
0x03A6	30935	R	word	AI-03_engineeringValueMaxHigh	04:INPUT REGISTER	high word
0x03A7	30936	R	word	AI-03_engineeringValueMaxLow	04:INPUT REGISTER	low word
0x03A8	30937	R	word	AI-04_engineeringValueMaxHigh	04:INPUT REGISTER	high word
0x03A9	30938	R	word	AI-04_engineeringValueMaxLow	04:INPUT REGISTER	low word
0x03AA	30939	R	word	AI-05_engineeringValueMaxHigh	04:INPUT REGISTER	high word
0x03AB	30940	R	word	AI-05_engineeringValueMaxLow	04:INPUT REGISTER	low word
0x03AC	30941	R	word	AI-06_engineeringValueMaxHigh	04:INPUT REGISTER	high word
0x03AD	30942	R	word	AI-06_engineeringValueMaxLow	04:INPUT REGISTER	low word
0x03AE	30943	R	word	AI-07_engineeringValueMaxHigh	04:INPUT REGISTER	high word
0x03AF	30944	R	word	AI-07_engineeringValueMaxLow	04:INPUT REGISTER	low word
0x03E0	30993	R	word	AI-00_status	04:INPUT REGISTER	0: normal, 1: burnout, 2: over range, 3: under range

Address (hex)	Register (decimal)	Access	Type	Parameter Name	Function Code	Description
0x03E1	30994	R	word	AI-01_status	04:INPUT REGISTER	0: normal, 1: burnout, 2: over range, 3: under range
0x03E2	30995	R	word	AI-02_status	04:INPUT REGISTER	0: normal, 1: burnout, 2: over range, 3: under range
0x03E3	30996	R	word	AI-03_status	04:INPUT REGISTER	0: normal, 1: burnout, 2: over range, 3: under range
0x03E4	30997	R	word	AI-04_status	04:INPUT REGISTER	0: normal, 1: burnout, 2: over range, 3: under range
0x03E5	30998	R	word	AI-05_status	04:INPUT REGISTER	0: normal, 1: burnout, 2: over range, 3: under range
0x03E6	30999	R	word	AI-06_status	04:INPUT REGISTER	0: normal, 1: burnout, 2: over range, 3: under range
0x03E7	31000	R	word	AI-07_status	04:INPUT REGISTER	0: normal, 1: burnout, 2: over range, 3: under range
0x02C0	40705	R/W	word	AI-00_mode	03:HOLDING REGISTER	0: 0-10 V, 1: 0-20 mA, 2: 4-20 mA burnout, 3: 4-20 mA
0x02C1	40706	R/W	word	AI-01_mode	03:HOLDING REGISTER	0: 0-10 V, 1: 0-20 mA, 2: 4-20 mA burnout, 3: 4-20 mA
0x02C2	40707	R/W	word	AI-02_mode	03:HOLDING REGISTER	0: 0-10 V, 1: 0-20 mA, 2: 4-20 mA burnout, 3: 4-20 mA
0x02C3	40708	R/W	word	AI-03_mode	03:HOLDING REGISTER	0: 0-10 V, 1: 0-20 mA, 2: 4-20 mA burnout, 3: 4-20 mA
0x02C4	40709	R/W	word	AI-04_mode	03:HOLDING REGISTER	0: 0-10 V, 1: 0-20 mA, 2: 4-20 mA burnout, 3: 4-20 mA
0x02C5	40710	R/W	word	AI-05_mode	03:HOLDING REGISTER	0: 0-10 V, 1: 0-20 mA, 2: 4-20 mA burnout, 3: 4-20 mA

Address (hex)	Register (decimal)	Access	Type	Parameter Name	Function Code	Description
0x02C6	40711	R/W	word	AI-06_mode	03:HOLDING REGISTER	0: 0-10 V, 1: 0-20 mA, 2: 4-20 mA burnout, 3: 4-20 mA
0x02C7	40712	R/W	word	AI-07_mode	03:HOLDING REGISTER	0: 0-10 V, 1: 0-20 mA, 2: 4-20 mA burnout, 3: 4-20 mA
0x02E0	40737	R/W	word	AI-00_burnoutValueHigh	03:HOLDING REGISTER	high word
0x02E1	40738	R/W	word	AI-00_burnoutValueLow	03:HOLDING REGISTER	low word
0x02E2	40739	R/W	word	AI-01_burnoutValueHigh	03:HOLDING REGISTER	high word
0x02E3	40740	R/W	word	AI-01_burnoutValueLow	03:HOLDING REGISTER	low word
0x02E4	40741	R/W	word	AI-02_burnoutValueHigh	03:HOLDING REGISTER	high word
0x02E5	40742	R/W	word	AI-02_burnoutValueLow	03:HOLDING REGISTER	low word
0x02E6	40743	R/W	word	AI-03_burnoutValueHigh	03:HOLDING REGISTER	high word
0x02E7	40744	R/W	word	AI-03_burnoutValueLow	03:HOLDING REGISTER	low word
0x02E8	40745	R/W	word	AI-04_burnoutValueHigh	03:HOLDING REGISTER	high word
0x02E9	40746	R/W	word	AI-04_burnoutValueLow	03:HOLDING REGISTER	low word
0x02EA	40747	R/W	word	AI-05_burnoutValueHigh	03:HOLDING REGISTER	high word
0x02EB	40748	R/W	word	AI-05_burnoutValueLow	03:HOLDING REGISTER	low word
0x02EC	40749	R/W	word	AI-06_burnoutValueHigh	03:HOLDING REGISTER	high word
0x02ED	40750	R/W	word	AI-06_burnoutValueLow	03:HOLDING REGISTER	low word
0x02EE	40751	R/W	word	AI-07_burnoutValueHigh	03:HOLDING REGISTER	high word
0x02EF	40752	R/W	word	AI-07_burnoutValueLow	03:HOLDING REGISTER	low word

ioLogik R1241 Modbus Address and Register Map

Address (hex)	Register (decimal)	Access	Type	Parameter Name	Function Code	Description
0x04A0	41185	R/W	word	AO-00_rawValue	03:HOLDING REGISTER	
0x04A1	41186	R/W	word	AO-01_rawValue	03:HOLDING REGISTER	

Address (hex)	Register (decimal)	Access	Type	Parameter Name	Function Code	Description
0x04A2	41187	R/W	word	AO-02_rawValue	03:HOLDING REGISTER	
0x04A3	41188	R/W	word	AO-03_rawValue	03:HOLDING REGISTER	
0x04C0	41217	R/W	word	AO-00_rawValuePowerOn	03:HOLDING REGISTER	
0x04C1	41218	R/W	word	AO-01_rawValuePowerOn	03:HOLDING REGISTER	
0x04C2	41219	R/W	word	AO-02_rawValuePowerOn	03:HOLDING REGISTER	
0x04C3	41220	R/W	word	AO-03_rawValuePowerOn	03:HOLDING REGISTER	
0x04E0	41249	R/W	word	AO-00_rawValueSafeMode	03:HOLDING REGISTER	
0x04E1	41250	R/W	word	AO-01_rawValueSafeMode	03:HOLDING REGISTER	
0x04E2	41251	R/W	word	AO-02_rawValueSafeMode	03:HOLDING REGISTER	
0x04E3	41252	R/W	word	AO-03_rawValueSafeMode	03:HOLDING REGISTER	
0x0500	41281	R/W	word	AO-00_mode	03:HOLDING REGISTER	0: 0-10 V, 1: 0-20 mA, 2: 4-20 mA
0x0501	41282	R/W	word	AO-01_mode	03:HOLDING REGISTER	0: 0-10 V, 1: 0-20 mA, 2: 4-20 mA
0x0502	41283	R/W	word	AO-02_mode	03:HOLDING REGISTER	0: 0-10 V, 1: 0-20 mA, 2: 4-20 mA
0x0503	41284	R/W	word	AO-03_mode	03:HOLDING REGISTER	0: 0-10 V, 1: 0-20 mA, 2: 4-20 mA

B

Factory Defaults

The ioLogik R1200 series comes configured with the following factory default settings:

Baudrate	9600
Data Bits	8
Parity	None
Stop Bits	1
Watchdog	Disable
Watchdog Time Out	10 seconds
Server Name	Blank
Server Location	Blank
DI Mode	DI
Filter Time	100 ms
Trigger for Counter	Lo to Hi
Counter Status	Stop
DO Mode	DO
DO Safe Status	Disable
Power On Status	Disable
Low Width for Pulses	1 ms (1.5 s for relay)
High Width for Pulses	1 ms (1.5 s for relay)
Output Pulses	0 (continuous)
DIO Mode	DO
AI Mode	Voltage
AO Mode	Voltage

C

Pinouts

R1210
(top to bottom)

1	COM 0	
2	DI0	
3	DI1	
4	DI2	
5	DI3	
6	GND	
7	DI4	
8	DI5	
9	DI6	
10	DI7	
11	COM 1	
12	DI8	
13	DI9	
14	DI10	
15	DI11	
16	GND	
17	DI12	
18	DI13	
19	DI14	
20	DI15	

R1212
(top to bottom)

1	COM0	
2	DI0	
3	DI1	
4	DI2	
5	DI3	
6	GND	
7	DI4	
8	DI5	
9	DI6	
10	DI7	
11	COM1	
12	DIO0	
13	DIO1	
14	DIO2	
15	DIO3	
16	GND	
17	DIO4	
18	DIO5	
19	DIO6	
20	DIO7	

R1214
(top to bottom)

1	COM	
2	DI0	
3	DI1	
4	DI2	
5	DI3	
6	DI4	
7	DI5	
8	GND	
9	R0_NO	
10	R0_C	
11	R1_NO	
12	R1_C	
13	R2_NO	
14	R2_C	
15	R3_NO	
16	R3_C	
17	R4_NO	
18	R4_C	
19	R5_NO	
20	R5_C	

R1240
(top to bottom)

1	AI0+	
2	AI0-	
3	AI1+	
4	AI1-	
5	AI2+	
6	AI2-	
7	AI3+	
8	AI3-	
9	AI4+	
10	AI4-	
11	AI5+	
12	AI5-	
13	AI6+	
14	AI6-	
15	AI7+	
16	AI7-	
17		
18		
19		
20		

R1241
(top to bottom)

1	VO0+	
2	VO0-	
3	IO0+	
4	IO0-	
5	VO1+	
6	VO1-	
7	IO1+	
8	IO1-	
9	VO2+	
10	VO2-	
11	IO2+	
12	IO2-	
13	VO3+	
14	VO3-	
15	IO3+	
16	IO3-	
17		
18		
19	EX_V	
20	EX_C	

D

FCC Interference Statement

Federal Communication Commission Warning

This equipment has been tested and found to comply with the limits for a Class A digital device, pursuant to part 15 of the FCC Rules. Operation is subject to the following two conditions: (1) This device may not cause harmful interference, and (2) this device must accept any interference received, including interference that may cause undesired operation.

These limits are designed to provide reasonable protection against harmful interference when the equipment is operated in a commercial environment. This equipment generates, uses, and can radiate radio frequency energy and, if not installed and used in accordance with the instruction manual, may cause harmful interference to radio communications. Operation of this equipment in a residential area is likely to cause harmful interference in which case the user will be required to correct the interference at his own expense.

E

European Community (CE)

This is a Class A product. In a domestic environment, this product may cause radio interference in which case the user may be required to take adequate measures.