

UC-3100 Series Hardware User's Manual

Version 2.0, September 2019

www.moxa.com/product



© 2019 Moxa Inc. All rights reserved.

UC-3100 Series Hardware User's Manual

The software described in this manual is furnished under a license agreement and may be used only in accordance with the terms of that agreement.

Copyright Notice

© 2019 Moxa Inc. All rights reserved.

Trademarks

The MOXA logo is a registered trademark of Moxa Inc.
All other trademarks or registered marks in this manual belong to their respective manufacturers.

Disclaimer

Information in this document is subject to change without notice and does not represent a commitment on the part of Moxa.

Moxa provides this document as is, without warranty of any kind, either expressed or implied, including, but not limited to, its particular purpose. Moxa reserves the right to make improvements and/or changes to this manual, or to the products and/or the programs described in this manual, at any time.

Information provided in this manual is intended to be accurate and reliable. However, Moxa assumes no responsibility for its use, or for any infringements on the rights of third parties that may result from its use.

This product might include unintentional technical or typographical errors. Changes are periodically made to the information herein to correct such errors, and these changes are incorporated into new editions of the publication.

Technical Support Contact Information

www.moxa.com/support

Moxa Americas

Toll-free: 1-888-669-2872
Tel: +1-714-528-6777
Fax: +1-714-528-6778

Moxa Europe

Tel: +49-89-3 70 03 99-0
Fax: +49-89-3 70 03 99-99

Moxa India

Tel: +91-80-4172-9088
Fax: +91-80-4132-1045

Moxa China (Shanghai office)

Toll-free: 800-820-5036
Tel: +86-21-5258-9955
Fax: +86-21-5258-5505

Moxa Asia-Pacific

Tel: +886-2-8919-1230
Fax: +886-2-8919-1231

Table of Contents

1. Introduction	1-1
Overview	1-2
Model Description	1-2
Package Checklist	1-2
Product Features	1-2
Hardware Specifications	1-3
2. Hardware Introduction	2-1
Appearance.....	2-2
LED Indicators.....	2-6
Monitoring the Function Button (FN Button) Action Using the SYS LED.....	2-6
Reset to Factory Default.....	2-7
Real-time Clock	2-7
Placement Options	2-7
3. Hardware Connection Description	3-1
Wiring Requirements.....	3-2
Connector Description	3-2
A. Regulatory Approval Statements	A-1

Introduction

The UC-3100 Series computing platform is designed for embedded data acquisition applications. The computer comes with two RS- 232/422/485 serial ports and dual auto-sensing 10/100 Mbps Ethernet LAN ports. These versatile communication capabilities let users efficiently adapt the UC-3100 to a variety of complex communications solutions.

The following topics are covered in this chapter:

- ❑ **Overview**
- ❑ **Model Description**
- ❑ **Package Checklist**
- ❑ **Product Features**
- ❑ **Hardware Specifications**

Overview

Moxa UC-3100 Series computers can be used as edge-field smart gateways for data pre-processing and transmission, as well as for other embedded data acquisition applications. The UC-3100 Series includes three models, each supporting different wireless options and protocols.

The UC-3100's advanced heat dissipation design makes it suitable for use in temperatures ranging from -30 to 70°C. In fact, the Wi-Fi and LTE connections can be used simultaneously in both cold and hot environments, allowing you to maximize your "data pre-processing" and "data transmission" capability in most harsh environments.

Model Description

Region	Model Name	Carrier Approval	Wi-Fi	BLT	CAN	SD	Serial
US	UC-3101-T-US-LX	Verizon, AT&T, T-Mobile	-	-	-	-	1
	UC-3111-T-US-LX		✓	✓	-	✓	2
	UC-3121-T-US-LX		✓	✓	1	✓	1
EU/APAC	UC-3101-T-EU-LX	-	-	-	-	-	1
	UC-3111-T-EU-LX		✓	-	-	✓	2
	UC-3121-T-EU-LX		✓	-	1	-	1
AU/NZS	UC-3101-T-AU-LX	Telstra, Optus	-	-	-	-	1
	UC-3111-T-AU-LX		✓	-	-	✓	2
	UC-3121-T-AU-LX		✓	-	1	-	1

Package Checklist

Before installing the UC-3100, verify that the package contains the following items:

- 1 x UC-3100 Arm-based computer
- 1 x DIN-rail mounting kit (preinstalled)
- 1 x Power jack
- 1 x 3-pin terminal block for power
- 1 x CBL-4PINDB9F-100: 4-pin pin header to DB9 female console port cable, 100 cm
- 1 x Quick installation guide (printed)
- 1 x Warranty card

NOTE: Notify your sales representative if any of the above items are missing or damaged.

Product Features

- Armv7 Cortex-A8 1000 MHz processor
- Integrated Wi-Fi 802.11a/b/g/n and LTE Cat 1 for the US, EU, APAC, and AUS regions
- Bluetooth 4.2 for the US region
- Industrial CAN 2.0 A/B protocol supported
- -30 to 70°C system operating temperature
- Meets the EN 61000-6-2 and EN 61000-6-4 standards for industrial EMC applications
- Ready-to-run Debian 9 with 10-year long-term support
- Robust Root File System to prevent the system from being bricked due to a firmware update failure

Hardware Specifications

NOTE The latest specifications for Moxa's products can be found at <https://www.moxa.com>.

Hardware Introduction

The UC-3100 embedded computers are compact and rugged making them suitable for industrial applications. The LED indicators help in monitoring performance and troubleshooting issues. The multiple ports provided on the computer can be used to connect to a variety of devices. The UC-3100 comes with a reliable and stable hardware platform that lets you devote the bulk of your time to application development. In this chapter, we provide basic information about the embedded computer's hardware and its various components.

The following topics are covered in this chapter:

- ❑ **Appearance**
- ❑ **LED Indicators**
- ❑ **Monitoring the Function Button (FN Button) Action Using the SYS LED**
 - Reset to Factory Default
- ❑ **Real-time Clock**
- ❑ **Placement Options**

Appearance

UC-3101

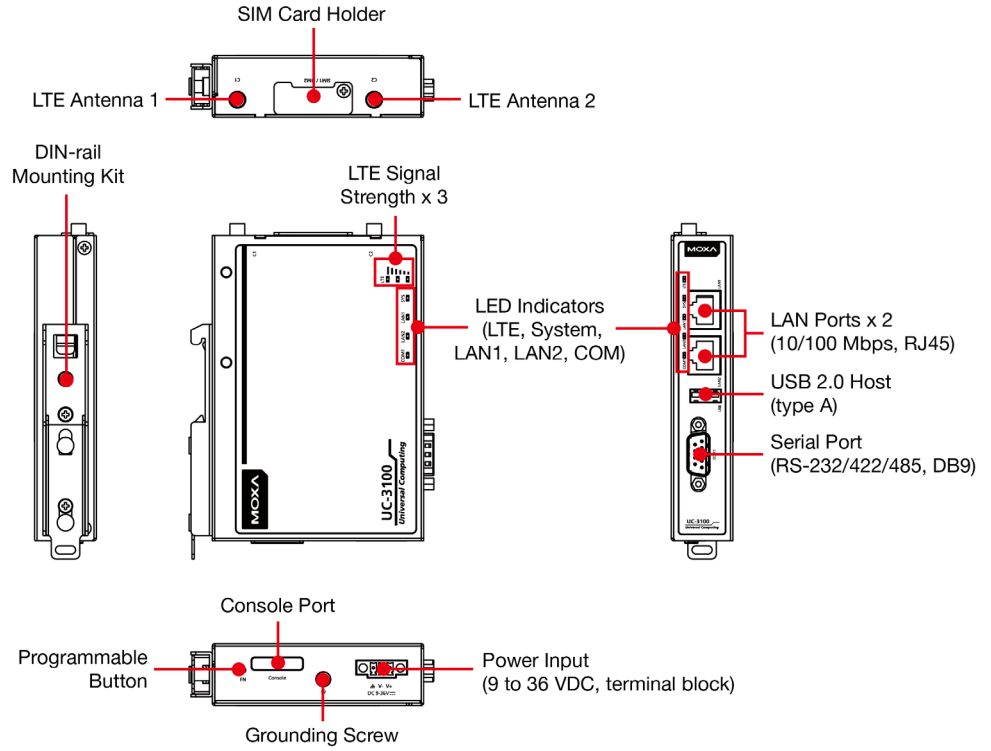

UC-3101 (US Model)

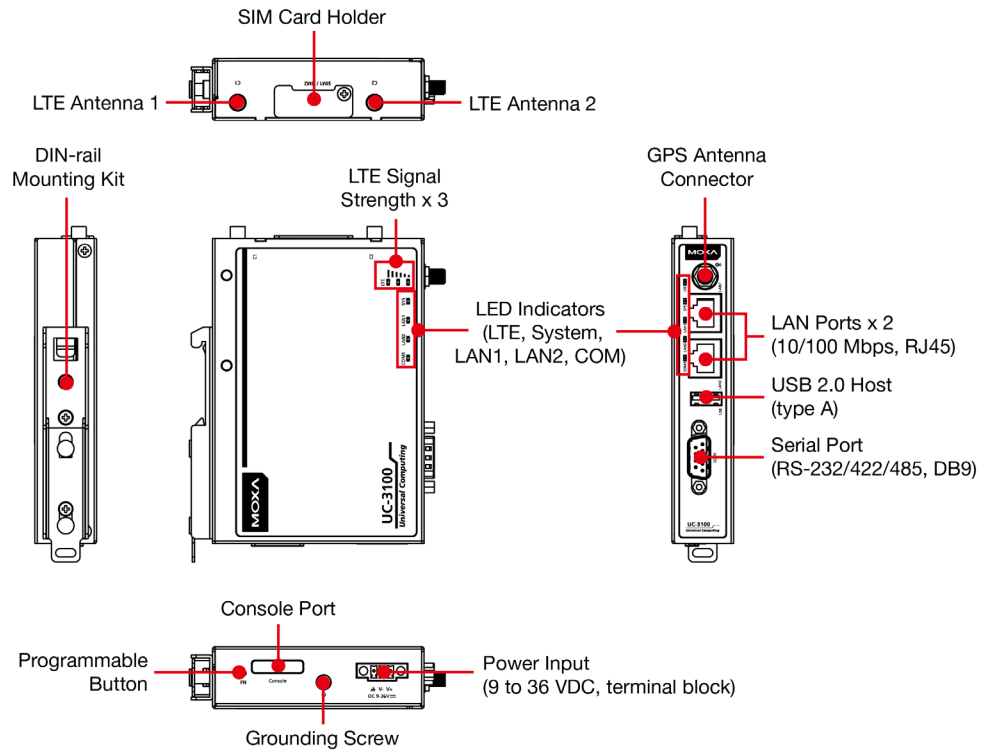

UC-3111

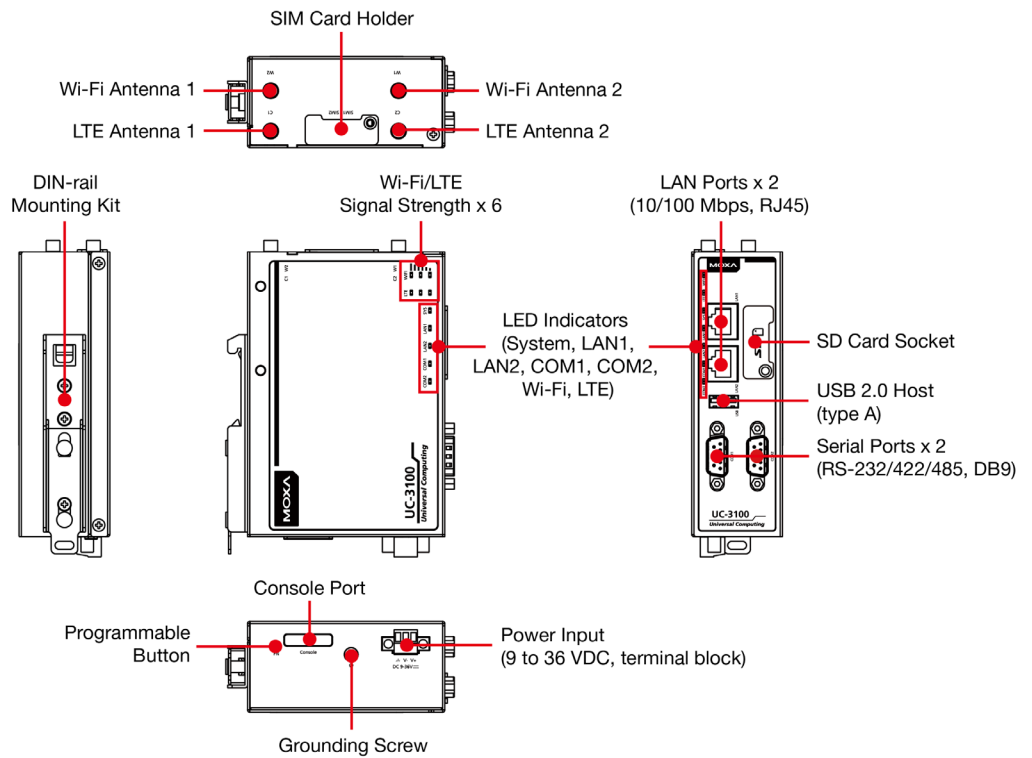

UC-3111 (US Model)

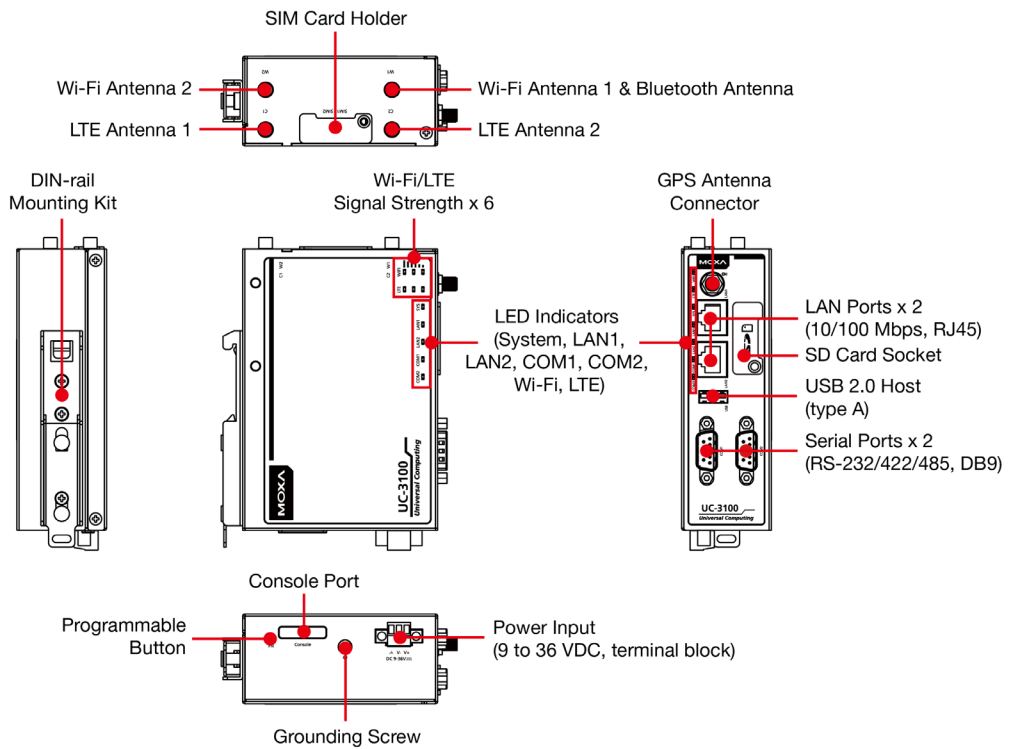

UC-3121

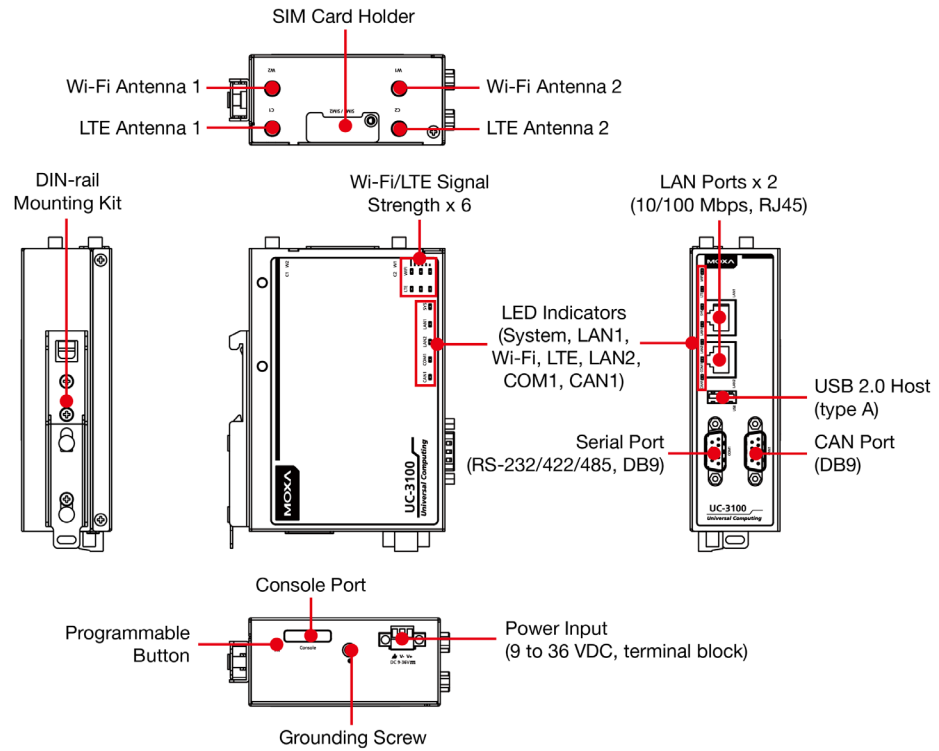

UC-3121 (US Version)

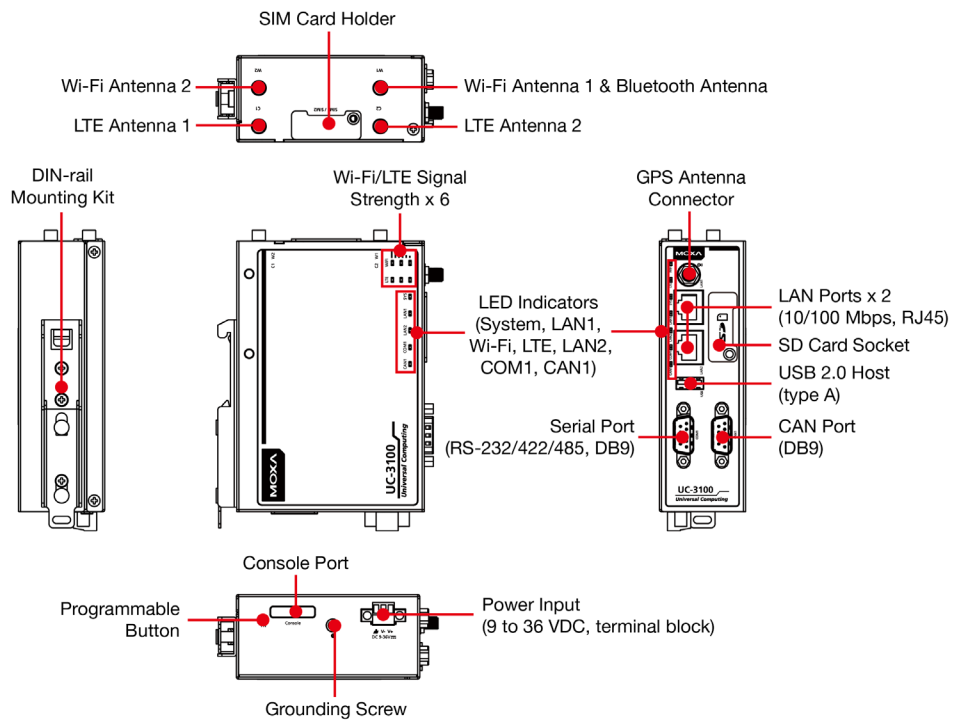

Dimensions [units: mm (in)]

UC-3101

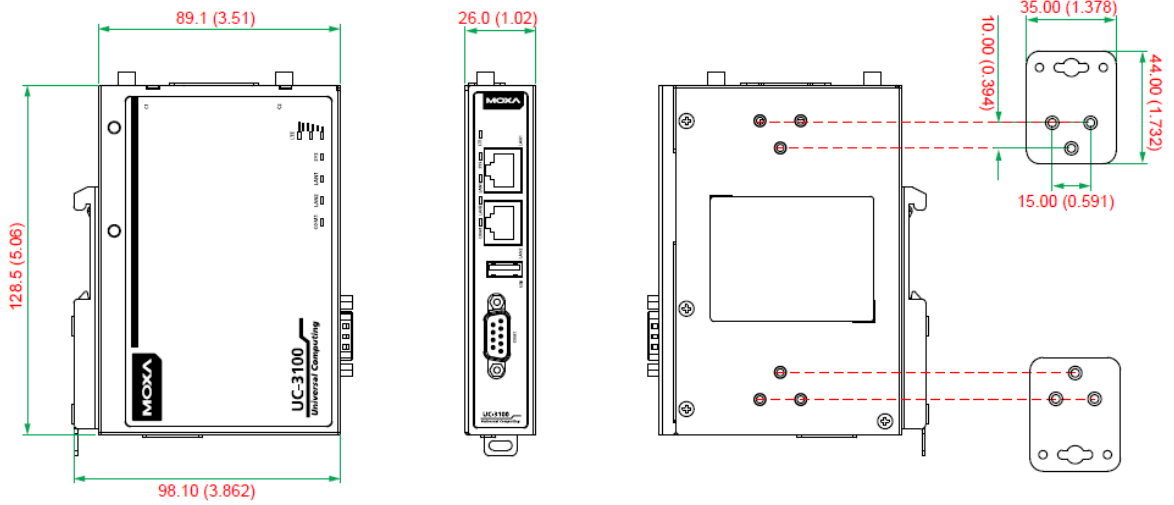

UC-3111

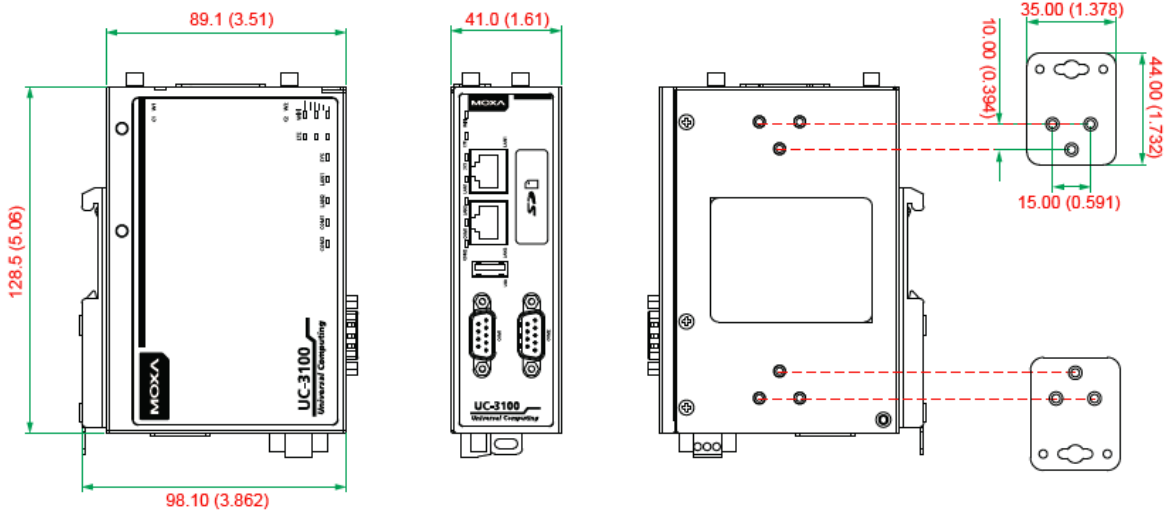

UC-3121

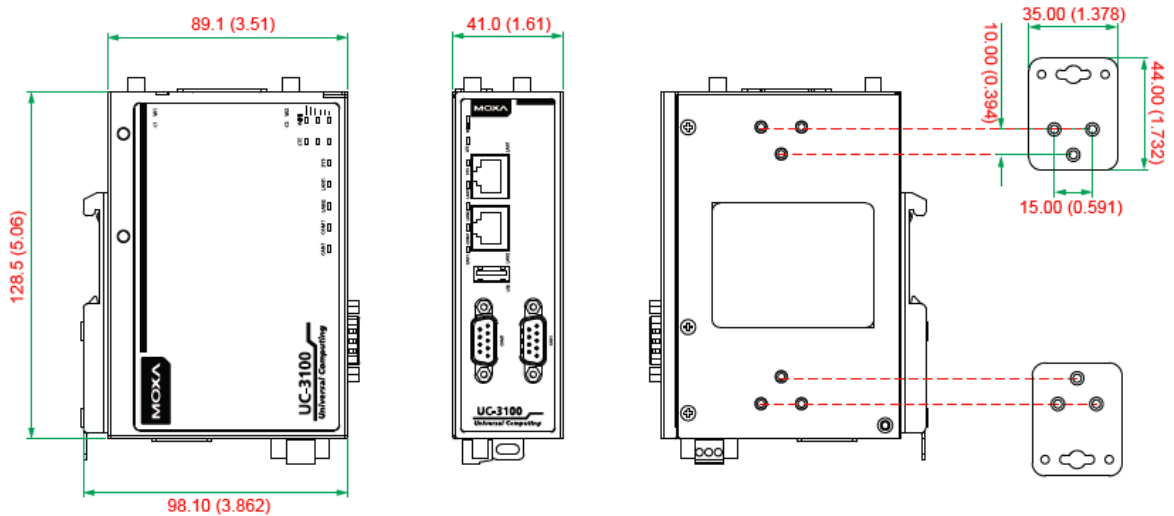

LED Indicators

Refer to the following table for information about each LED.

LED Name	Status	Function	Notes
SYS	Green	Power is on	Refer to the <i>Monitoring the Function Button (FN Button) Action Using the SYS LED</i> section for more details.
	Red	FN button is pressed	
	Off	Power is off	
LAN1/ LAN2	Green	10/100 Mbps Ethernet mode	
	Off	Ethernet port is not active	
COM1/ COM2/ CAN1	Orange	Serial/CAN port is transmitting or receiving data	
	Off	Serial/CAN port is not active	
Wi-Fi	Green	Wi-Fi connection has been established	Client mode: 3 levels with signal strength 1 LED is on: Poor signal quality 2 LEDs are on: Good signal quality All 3 LEDs are on: Excellent signal quality AP mode: All 3 LEDs blinking at the same time
	Off	Wi-Fi interface is not active	
LTE	Green	Cellular connection has been established	3 levels with signal strength 1 LED is on: Poor signal quality 2 LEDs are on: Good signal quality All 3 LEDs are on: Excellent signal quality
	Off	Cellular interface is not active	

Monitoring the Function Button (FN Button) Action Using the SYS LED

The FN button is used to perform software reboot or to perform firmware restoration. Pay attention to the SYS LED indicator and release the FN button at the appropriate time to enter the correct mode to either reboot your device or restore your device to the default configuration.

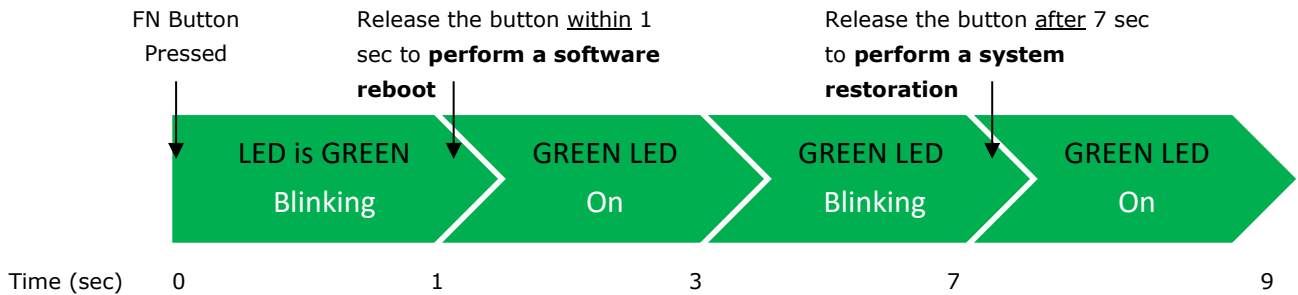

The mapping of the action on the FN button with the behavior of the SYS LED and the resulting system status is given below:

System Status	FN Button Action	SYS LED behavior
Reboot	Press and release within 1 sec	Green, blinking until the FN button is released
Restore	Press and hold for over 7 sec	

Reset to Factory Default

For details on resetting your device to factory default values, refer to the *Function Button and LED Indicators* section.



ATTENTION

Reset to Default will erase all the data stored on the boot storage

Please back up your files before resetting the system to the factory default configuration. All the data stored in the UC-3100's boot storage will be erased when it is reset to the factory default configuration.

Real-time Clock

The real-time clock in the UC-3100 is powered by a lithium battery. We strongly recommend that you do not replace the lithium battery without the help of a Moxa support engineer. If you need to change the battery, contact the Moxa RMA service team.



WARNING

There is a risk of explosion if the battery is replaced with an incorrect battery type.

Placement Options

The UC-3100 computer can be mounted on to a DIN rail or on a wall. The DIN-rail mounting kit is attached by default. To order a wall-mounting kit, contact a Moxa sales representative.

DIN-rail Mounting

To mount the UC-3100 on to a DIN rail, do the following:

1. Pull down the slider of the DIN-rail bracket located at the back of the unit
2. Insert the top of the DIN rail into the slot just below the upper hook of the DIN-rail bracket.
3. Latch the unit firmly on to the DIN rail as shown in the illustrations below.
4. Once the computer is mounted properly, you will hear a click and the slider will rebound back into place automatically.

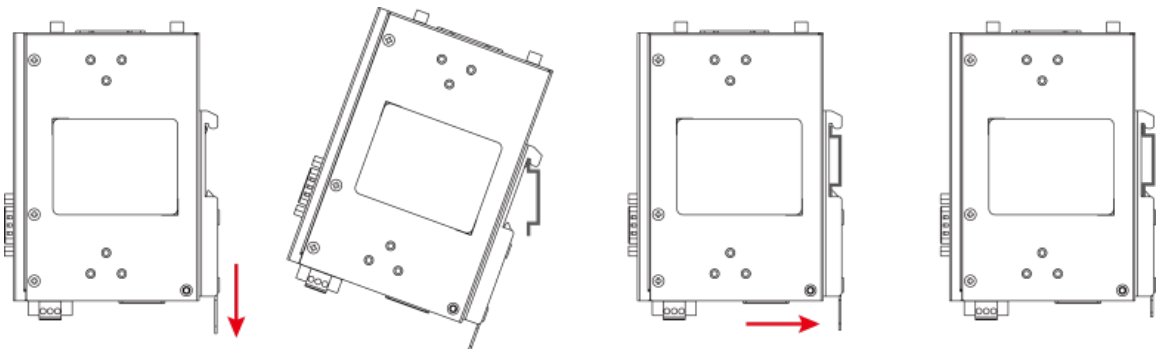

Wall Mounting (optional)

The UC-3100 can also be wall mounted. The wall-mounting kit needs to be purchased separately. Refer to datasheet for more information.

1. Fasten the wall-mounting kit to the UC-3100 as shown below:

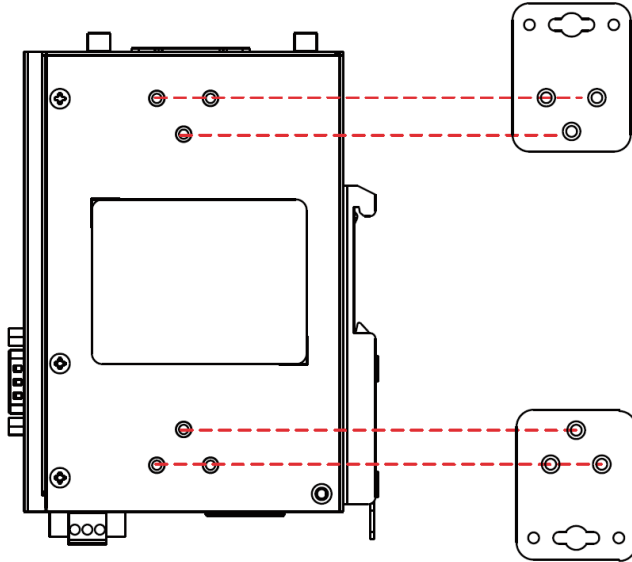

2. Use two screws to mount the UC-3100 on to a wall.



ATTENTION

The wall-mounting kit is not included in the package and must be purchased separately.

Hardware Connection Description

This section describes how to connect the UC-3100 to a network and connect various devices to the UC-3100.

The following topics are covered in this chapter:

▣ **Wiring Requirements**

➤ Connector Description

Wiring Requirements

In this section, we describe how to connect various devices to the embedded computer. You must pay attention to the following common safety precautions, before proceeding with the installation of any electronic device:

- Use separate paths to route wiring for power and devices. If power wiring and device wiring paths must cross, make sure the wires are perpendicular at the intersection point.
NOTE: Do not run the wires for signal or communication and power wiring in the same wire conduit. To avoid interference, wires with different signal characteristics should be routed separately.
- You can use the type of signal transmitted through a wire to determine which wires should be kept separate. The rule of thumb is that wiring that shares similar electrical characteristics can be bundled together.
- Keep input wiring and output wiring separate.
- We strongly advise that you label wiring to all devices in the system for easy identification.



ATTENTION

Safety First!

Be sure to disconnect the power cord before installing and/or wiring the computer.

Electrical Current Caution!

Calculate the maximum possible current in each power wire and common wire. Observe all electrical codes dictating the maximum current allowable for each wire size.

If the current goes above the maximum ratings, the wiring could overheat, causing serious damage to your equipment.

Temperature Caution!

Be careful when handling the unit. When the unit is plugged in, the internal components generate heat, and consequently the outer casing may be hot to touch by hand.

Connector Description

Power Connector

Connect the power jack (in the package) to the UC-3100's DC terminal block (located on the bottom panel), and then connect the power adapter. It takes several seconds for the system to boot up. Once the system is ready, the SYS LED will light up.

Grounding the UC-3100

Grounding and wire routing help limit the effects of noise due to electromagnetic interference (EMI). There are two ways to connect the UC-3100 grounding wire to the ground.

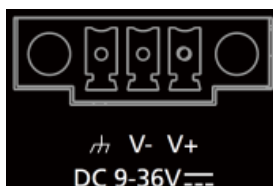

1. Through the SG (Shielded Ground, sometimes called Protected Ground):

The SG contact is the left-most contact in the 3-pin power terminal block connector when viewed from the angle shown here. When you connect to the SG contact, the noise will be routed through the PCB and the PCB copper pillar to the metal chassis.



2. Through the GS (Grounding Screw):

The GS is located between the console port and the power connector. When you connect to the GS wire, the noise is routed directly from the metal chassis.

Ethernet Port

The 10/100 Mbps Ethernet port uses the RJ45 connector. The pin assignment of the port is shown below:

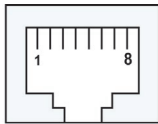

Pin	Signal
1	ETx+
2	ETx-
3	ERx+
4	-
5	-
6	ERx-
7	-
8	-

Serial Port

The serial port uses the DB9 male connector. It can be configured by software for the RS-232, RS-422, or RS-485 mode. The pin assignment of the port is shown below:

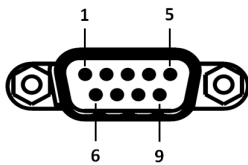

Pin	RS-232	RS-422	RS-485
1	DCD	TxD-(A)	-
2	RxD	TxD+(A)	-
3	TxD	RxD+(B)	Data+(B)
4	DTR	RxD-(A)	Data-(A)
5	GND	GND	GND
6	DSR	-	-
7	TRS	-	-
8	CTS	-	-
9	-	-	-

CAN Port (UC-3121 only)

The UC-3121 comes with a CAN port which uses the DB9 male connector and is compatible with the CAN 2.0A/B standard. The pin assignment of the port is shown below:

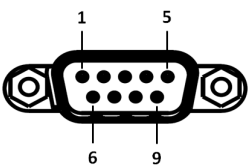

Pin	Signal Name
1	-
2	CAN_L
3	CAN_GND
4	-
5	CAN_SHLD
6	GND
7	CAN_H
8	-
9	CAN_V+

SIM Card Socket

The UC-3100 comes with two nano-SIM card sockets for cellular communication. The nano-SIM card sockets are located on the same side as the antenna panel. To install the cards, remove the screw and the protection cover to access the sockets, and then insert the nano-SIM cards into the sockets directly. You will hear a click when the cards are in place. The left socket is for SIM 1 and the right socket is for SIM 2. To remove the cards, push the cards in before releasing them.

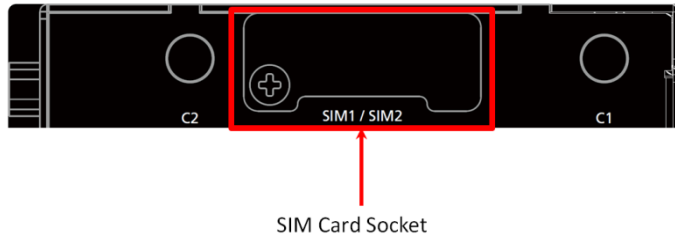

RF Connectors

The UC-3100 comes with RF connectors to the following interfaces.

Wi-Fi

The UC-3100 comes with a built-in Wi-Fi module (UC-3111 and UC-3121 only). You must connect the antenna to the RP-SMA connector before you can use the Wi-Fi function. The W1 and W2 connectors are interfaces to the Wi-Fi module.

Bluetooth

The UC-3100 comes with a built-in Bluetooth module (UC-3111 and UC-3121 US region only). You must connect the antenna to the RP-SMA connector before you can use the Bluetooth function. The W1 connector is the interface to the Bluetooth module.

Cellular

The UC-3100 comes with a built-in cellular module. You must connect the antenna to the SMA connector before you can use the cellular function. The C1 and C2 connectors are interfaces to the cellular module.

For additional details refer to the UC-3100 datasheet.

SD Card Socket (UC-3111 and UC-3121 US only)

The UC-3111 comes with a SD-card socket for storage expansion. The SD card socket is located next to the Ethernet port. To install the SD card, remove the screw and the protection cover to access the socket, and then insert the SD card into the socket. You will hear a click when the card is in place. To remove the card, push the card in before releasing it.

Console Port

The console port is an RS-232 port that you can connect to with a 4-pin pin header cable (in the package). You can use this port for debugging or firmware upgrade.

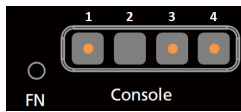

Pin	Signal
1	GND
2	NC
3	RxD
4	TxD

USB

The USB port is a type-A USB 2.0 version port, which can be connected with a USB storage device or other type-A USB compatible devices.

A

Regulatory Approval Statements



This device complies with part 15 of the FCC Rules. Operation is subject to the following two conditions: (1) This device may not cause harmful interference, and (2) this device must accept any interference received, including interference that may cause undesired operation.

Class A: FCC Warning! This equipment has been tested and found to comply with the limits for a Class A digital device, pursuant to part 15 of the FCC Rules. These limits are designed to provide reasonable protection against harmful interference when the equipment is operated in a commercial environment. This equipment generates, uses, and can radiate radio frequency energy and, if not installed and used in accordance with the instruction manual, may cause harmful interference to radio communications. Operation of this equipment in a residential area is likely to cause harmful interference in which case the users will be required to correct the interference at their own expense.



European Community



WARNING

This is a class A product. In a domestic environment this product may cause radio interference in which case the user may be required to take adequate measures.
