



# Perle IDS-105F (XT) Unmanaged 10/100 Ethernet Switches



## Installation Guide

# Overview

This document contains instructions necessary for the installation and operation of the Perle IDS-105F Ethernet switch. This Ethernet switch can be ordered as a 5-port RJ-45 switch or with 4 RJ-45 ports and one SC or ST fiber port. The fiber port can be either single mode (SM) or multimode (MM) depending on the model selected and they can operate over different wavelengths and distances. Visit the Perle website for the most up to date installation guides, models and specifications.

<http://www.perle.com/>

Model	Port 1 - 4	Port 5
IDS-105F	TP (RJ-45)	TP (RJ-45)
IDS-105F-xxxxxxx	TP (RJ-45)	Fiber port
IDS-105F-XT (Industrial Temperature)	TP (RJ-45)	TP (RJ-45)
IDS-105F-xxxxxxx-XT (Industrial Temperature)	TP (RJ-45)	Fiber port

**Note:** xxxxxxx indicates models numbers for this product line.

**TP** = twisted pair

**XT** – Extended temperature models

## Features

- 10/100Base-TX with one SC/ST fiber port, multi/single mode
- IEEE 802.3/802.3u/802.3x
- 10/100, Full/Half duplex, MDI/MDIX with auto-sensing
- Auto-negotiation on copper ports
- Redundant DC power inputs
- Rugged high-strength case
- Industrial temperature models
- Din-rail or wall/panel mounting

**Note** – In this guide the various models will be referred to as the **IDS-105F**

# Getting to know your IDS-105F Switch

## Package Contents:

- IDS-105F
- DIN-rail mounting clip (pre-installed on the unit)
- This guide

*Note – Optional panel/wall mounting kits may be ordered*

## Front View of IDS-105F (5 port RJ-45)

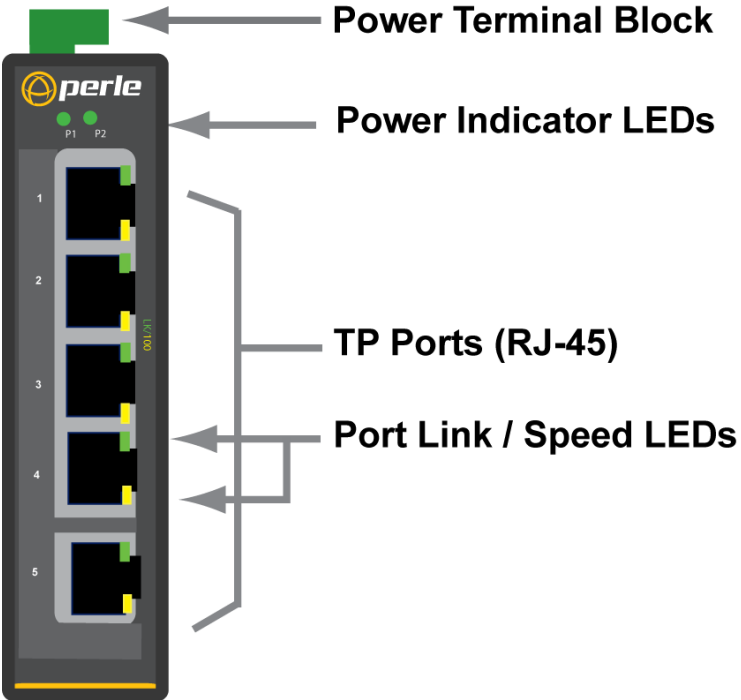

## Front View of IDS-105F (with one fiber port)

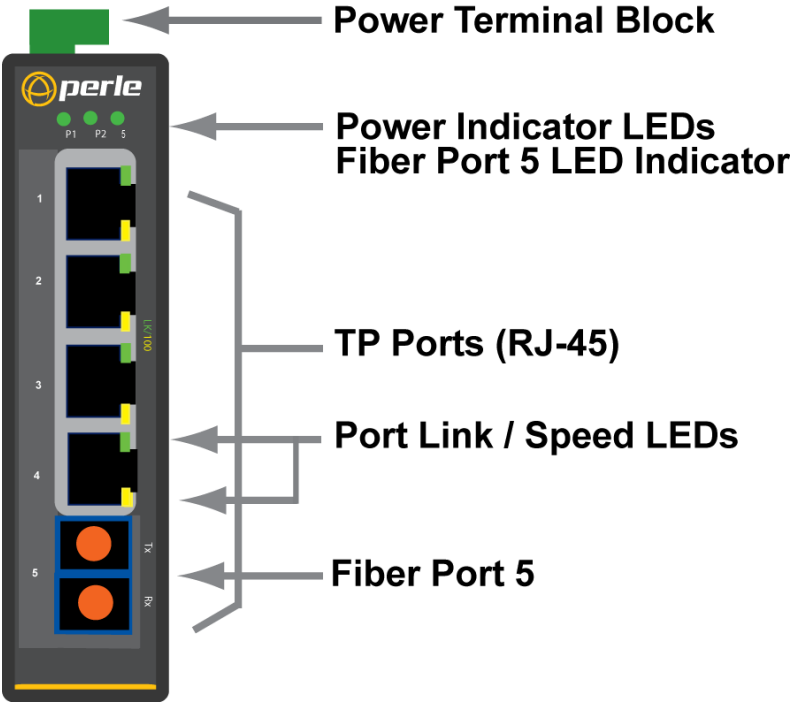

## Top view of the IDS-105F

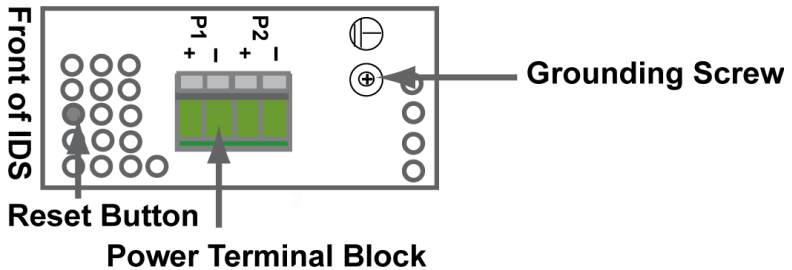

# Power

The IDS-105F switch has two power inputs that can be connected simultaneously to DC or AC power sources. If one power source fails, the other acts as a backup, and automatically powers the switch.

# Reset Button

To reset the IDS-105F insert a paper clip into the air hole vent and gently press the reset button. The LEDs on the IDS-105F will go On and then momentarily Off when released to show that the unit has been reset. All links will be dropped and the MAC tables will be cleared.

# LED Status

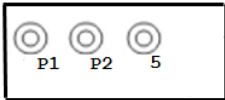

## P1 / P2– Power (Green LED)

- **On:** Power present
- **Off:** No Power present

## Fiber Port 5 (Green LED)

- **On:** Link up
- **Flashing:** Link up and Ethernet activity detected
- **Off:** Link down

# Ethernet Port Status



## Port Link / Speed (Green and Yellow LEDs)

- **On:** Link Up
- 100 Mbps    Green on
- 10 Mbps     Green off
- **Flashing:** Link up and Ethernet activity detected
- **Off :** Link down

# Dimensions for the IDS-105F

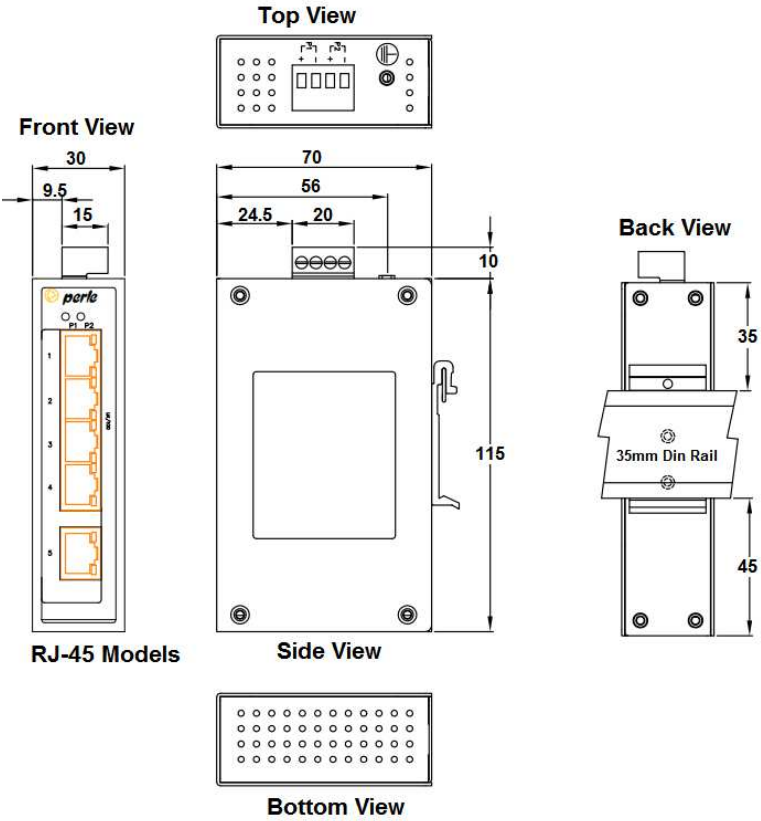

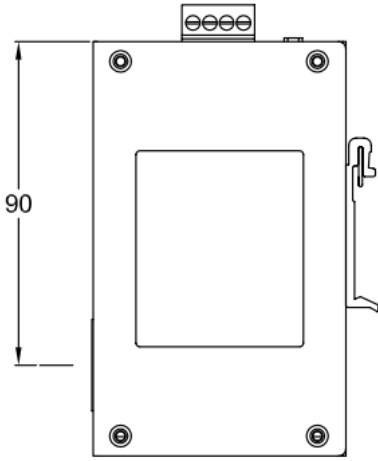

SC Fiber Models

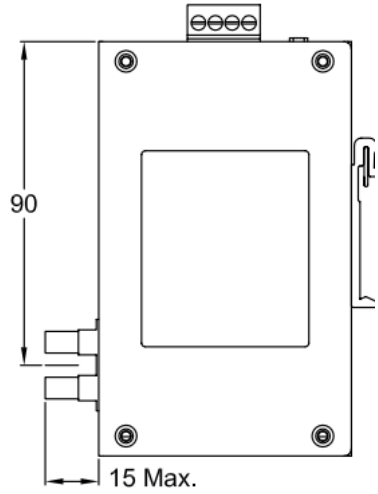

ST Fiber Models

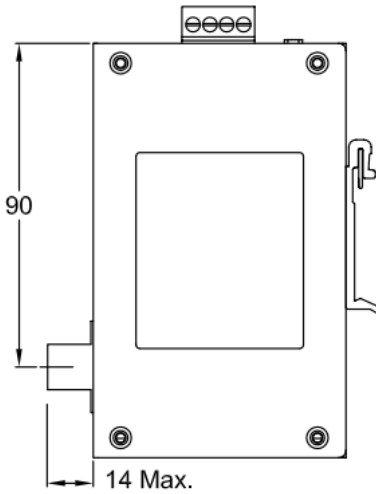

Single Fiber Models



# Mounting the IDS-105F on a DIN-rail

1. The DIN-rail clip will be fixed to the back panel of the IDS-105F when you receive the product.
2. Position the IDS-105F such that the top of the DIN-rail fits into the slot on the top of the DIN-rail clip, just below the hook and behind the spring.
3. While pushing down on the unit to compress the spring, rotate the bottom of the IDS-105F toward the rail. This will snap the bottom of the rail into the bottom of the clip. See diagram below

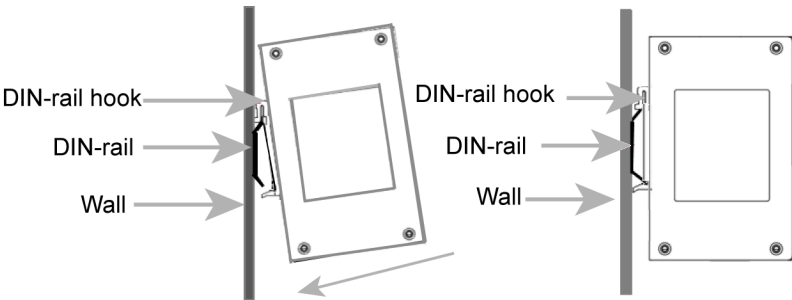

**Note:** To remove the IDS-105F from the DIN-rail, push down slightly on the IDS-105F unit while pulling the bottom out.

# Wall Mounting the IDS-105F

1. Remove the DIN-rail clip from the rear panel on the IDS-105F.
2. Attach the wall mount plates to the IDS-105F as shown below using the screws provided in the kit.

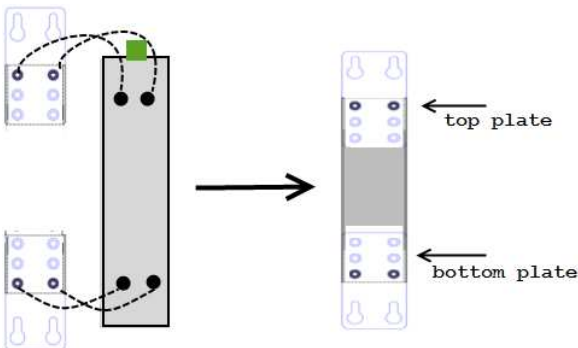

3. Use the wall mount plates as a guide to mark the spots where the screws will be.
4. Drive the screws into the wall leaving about 2 mm of the screw protruding from the wall to allow room for sliding the wall mount panel between the wall and the screws.
5. Once the screws are fixed to the wall, insert the four screw heads through the large part of the keyhole shaped screw openings.
6. Pull the IDS-105F down to lock the IDS-105F to the wall mount.
7. Tighten the four screws securely to the wall.

**Note: For the best results use screws that have the following attributes:**  
**Head diameter .5 - .6 mm**  
**Shaft diameter 3 - 3.5 mm**

### **Wall/Panel Mounting**

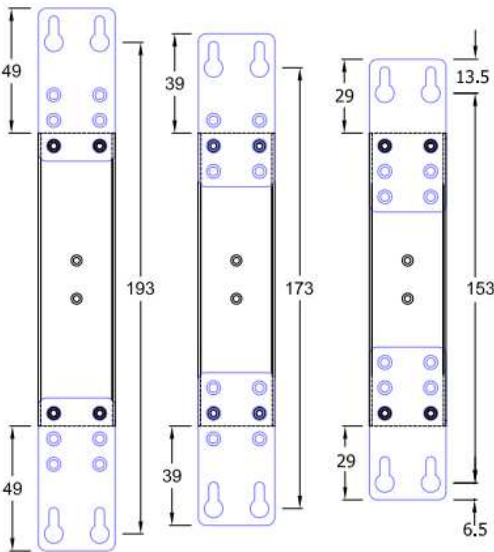

**Note: the dimensions are in mm**

# Wiring up the IDS-105F



Power sources must be off prior to beginning the power connection steps.



Ensure that the voltage and current ratings of the intended power source are appropriate for the IDS-105F as indicated on the product label.



Ensure that the installation and electrical wiring of the equipment is performed by trained and qualified personnel and that the installation complies with all local and national electrical codes



If this unit is to be installed in a location where the ambient temperature exceeds 50C, the case temperature may exceed safe levels. For this reason, this unit should be installed in a restricted access location where access can only be gained by service personnel or users who have been instructed about the reasons for the restrictions applied to the location and about any precautions that shall be taken; and access is through the use of a tool or lock and key, or other means of security, and is controlled by the authority responsible for the location.

## Hazardous Location Warnings

(safe conditions for use:)



Subject devices are to be installed in an ATEX Certified IP54 (as defined in IEC 60529) enclosure and accessible only by the use of a tool.



Subject devices are for use in an area of not more than pollution degree 2 in accordance with IEC 60664-1.



These devices are open-type devices that are to be installed in an enclosure with tool removable cover or door, suitable for the environment.



This equipment is suitable for use in Class I, Division 2, Groups A,B,C,D or non hazardous locations only.



**WARNING –EXPLOSION HAZARD –** Do not disconnect equipment unless power has been removed or the area is known to be non-hazardous



**WARNING EXPLOSION HAZARD –** Substitution of any components on this switch may impair suitability for Class I, Division 2.



Provision shall be made to prevent the rated voltage being exceeded by the transient disturbances of more than 140% of the peak rated voltage.

# Connecting the IDS-105F to ground

If your installation requires additional grounding follow this procedure.

1. Select and obtain an appropriate grounding lug that can be affixed to the ground screw on the top of the IDS-105F.
2. Follow the grounding lug manufacturer's instructions for attaching it to the ground wire.
3. Attach the grounding lug to the chassis and secure with the grounding screw provided.



Grounding the chassis requires the following items:

- One grounding lug (not provided)
- One 12 AWG wire (not provided)

# Connecting Power to the IDS-105F

1. Ensure the power source is off prior to connection.
2. Strip both (12-20 AWG) wires 5mm (3/16<sup>th</sup> inch).
3. Loosen the terminal block screws for P1 and connect positive (+) and negative (-) wires into the -/+ terminals.
4. Tighten terminal screws (.51Nm torque).
5. Ensure the wires are securely fastened.
6. Re-insert the Terminal block connector if removed.
7. Turn on power source.
8. Check that the P1 LED is On.
9. If desired connect P2 (power source 2, beginning at Step 1).
10. One individual conductor for each clamping point.

## Ethernet Copper Cabling Requirements

- Category 5 UTP or STP
- 24-22 AWG
- Straight through or Ethernet crossover cable

Connect the copper cables from each TP port (RJ-45) on the IDS-105F switch to Ethernet-enabled devices. See below for pinouts.

### 8-pin RJ-45

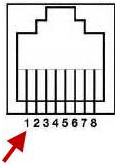

#### MDI Port Pinouts

Pin	Signal
1	Tx+
2	Tx-
3	Rx+
6	Rx-

#### MDI-X Port Pinouts

Pin	Signal
1	Rx+
2	Rx-
3	Tx+
6	Tx-

*Remaining pins not used.*

## Fiber Port Cabling Requirements

**MM:** 50/125 microns or 62.5/125 microns

**SM:** 9/125 microns

Connect the fiber cable to Port 5 on the IDS-105F and the other end to a compliant fiber device. If you are making your own fiber cables, remember that the RX on one side needs to go to TX on the other side and vice versa. See diagram below.

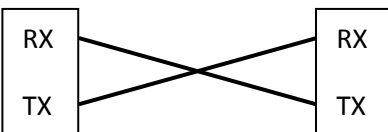



















# Technical Specifications

<b>Connection</b>	
Dual input terminal block power	<b>Power Input/Consumption</b> 9.6 to 60 VDC, 0.37A max 18 to 30 VAC, 0.3A max
Reverse Polarity Protection	Yes
<b>Interface</b>	
RJ-45	10/100Base-TX, auto negotiation speed, F/H duplex mode and auto MDI/MDI-X
Fiber Port	1 SC or ST fiber port
LED Indicators	P1 – power 1 P2 – power 2 Ports 1 – 4 G/Y – Link/Activity/Speed Ports 5 – port status (Fiber models only)
<b>Environmental</b>	
Operating Temperature Commercial Models (IDS-105F-xxxxxxx) Industrial Models (IDS-105F-xxxxxxx-XT)	0°C to 60°C (32°F to 140°F) -40°C to 75°C (-40°F to 167°F)
Storage Temperature Commercial Models (IDS-105F-xxxxxxx) Industrial Models (IDS-105F-xxxxxxx-XT)	-25°C to 70°C (-13°F to 158°F) -40°C to 85°C (-40°F to 185°F)
Operating Humidity	5% to 90% non-condensing
Storage Humidity	5% to 95% non-condensing
Operating Altitude	Up to 3,048 m (10,000 ft)
<b>Regulatory Approvals</b>	
Safety	cUL 60950-1, EN 60950-1
Industrial	UL 508
Industrial Hazardous Locations	ANSI/ISA 12.12.01-2013 Class I Division 2 Groups A-D ATEX Class I Zone 2 CENELEC EN 60079-0:2012+A11:2013 CENELEC EN 60079-15:2010 IEC 60079-0 Edition 6 – Revision Date 2012-11-01 IEC 60079-15 – Edition 4 – Issue Date 2010-01-01
Laser Safety	Transmitters: EN60825-1:2007 FDA/CDRH 21 CFR1040.11/CFR1040.11
EMI/EMC	FCC 47 Part 15 – Class B CISPR22 :2008 / EN55022 :2010 Class B CISPR 24 :2010 / EN55024

# Model Specifications

IDS-105F	Fiber Connector	Mode	Distance	Wavelength models (nm)	TX Power (dB)	RX Power (dB)	Budget
IDS-105F- (XT)	None	n/a	n/a	n/a	n/a	n/a	n/a
IDS-105F-M2SC2- (XT)	SC	MM duplex	2 km 1.2 miles	TX: 1310 RX:1310	Min:-6 Max:-0	Min:-17 Max:-0	11
IDS-105F-M2ST2- (XT)	ST	MM duplex	2 km 1.2 miles	TX: 1310 RX:1310	Min:-6 Max:-0	Min:-17 Max:-0	11
IDS-105F-M1SC2U	SC	MM duplex	2 km 1.2 miles	TX: 1310 RX:1550	Min:-15 Max:-8	Min:-28 Max:-3	13
IDS-105F--M1SC2D	SC	MM duplex	2 km 1.2 miles	TX: 1550 RX:1310	Min:-15 Max:-8	Min:-28 Max:-3	13
IDS-105F-S2SC20- (XT)	SC	SM duplex	20 km 12.4 miles	TX: 1310 RX:1310	Min:-15 Max:-8	Min:-34 Max:3	19
IDS-105F-S2ST20- (XT)	ST	SM duplex	20 km 12.4 miles	TX: 1310 RX:1310	Min:-15 Max:-8	Min:-32 Max:-3	17
IDS-105F-S1SC20U- (XT)	SC	SM duplex	20 km 12.4 miles	TX: 1310 RX:1490	Min:-8 Max:-3	Min:-22 Max:-3	14
IDS-105F--S1SC20D- (XT)	SC	SM duplex	20 km 12.4 miles	TX: 1490 RX:1310	Min:-8 Max:-3	Min:-22 Max:-3	14
IDS-105F-S2SC40- (XT)	SC	SM duplex	40 km 24.9 miles	TX: 1310 RX:1310	Min:-3 Max:-5	Min:-23 Max:-3	20
IDS-105F-S2ST40- (XT)	ST	SM duplex	40 km 24.9 miles	TX: 1310 RX:1310	Min:-3 Max:-5	Min:-23 Max:-3	20
IDS-105F-S1SC40U	SC	SM duplex	40 km 24.9 miles	TX: 1310 RX:1490	Min:-3 Max:-5	Min:-23 Max:-3	20
IDS-105F--S1SC40D	SC	SM duplex	40 km 24.9 miles	TX: 1490 RX:1310	Min:-3 Max:-5	Min:-23 Max:-3	20
IDS-105F-S2SC80	SC	SM duplex	80 km 49.7 miles	TX: 1550 RX:1550	Min: -5 Max: 0	Min-34 Max: -3	29
IDS-105F-S2ST80	ST	SM duplex	80 km 49.7 miles	TX: 1550 RX:1550	Min: -5 Max: 0	Min-34 Max: -3	29
IDS-105F-S2SC120	SC	SM duplex	120 km 74.6 miles	TX: 1550 RX:1550	Min:0 Max:5	Min:-32 Max:-9	32
IDS-105F-S2ST120	ST	SM duplex	120 km 74.6 miles	TX: 1550 RX:1550	Min:0 Max:5	Min:-32 Max:-9	32

# Product Label (samples)

 <p>Model: IDS-105F P/N: 07010000 S/N: 320-012814T10001</p>  <p>CE FC    </p> <p>Input: 9.6-60VDC, 0.37A max, Class2 18-30VAC, 50/60Hz, 0.30A max, Class2</p> <p> II 3G            </p> <p>DEMKO 14 ATEX 1342X Ex nA IIC T4 Gc 0°C ≤ Tamb ≤ 60°C</p> <p>60 Renfrew Drive, Markham, Ontario, Canada. L3R 0E1</p> <p>IND. CONT. EQ. FOR HAZ. LOC. Class I, Division 2, Groups A, B, C and D Temp. Code T4A Max. Ambient: 60 Deg. C</p> <p>IND. CONT. EQ. Max. Surrounding Air Temp. 60 Deg. C</p> <p>Made in Taiwan</p>	 <p>Model:IDS-105F-XT P/N: 07010190 S/N: 320-182814T10001</p>  <p>CE FC     </p> <p>Input: 9.6-60VDC, 0.37A max, Class2 18-30VAC, 50/60Hz, 0.30A max, Class2</p> <p> II 3G            </p> <p>DEMKO 14 ATEX 1342X Ex nA IIC T4 Gc -40°C ≤ Tamb ≤ 75°C Rated Cable Temp &gt; 90°C</p> <p>60 Renfrew Drive, Markham, Ontario, Canada. L3R 0E1</p> <p>IND. CONT. EQ. FOR HAZ. LOC. Class I, Division 2, Groups A, B, C and D Temp. Code T4 Max. Ambient: 75 Deg. C</p> <p>IND. CONT. EQ. Max. Surrounding Air Temp. 75 Deg. C</p> <p>Made in Taiwan</p>
--	--

For models IDS-105F-xxxxxxx

For models IDS-105F-xxxxxxx-XT

## Contacting Technical Support

Contact information for the Perle Technical Assistance Center (PTAC) can be found at the link below. A Technical Support Query may be made via this web page.

[www.perle.com/support\\_services/support\\_request.shtml](http://www.perle.com/support_services/support_request.shtml)

Warranty / Registration

[http://www.perle.com/support\\_services/warranty.shtml](http://www.perle.com/support_services/warranty.shtml)

Copyright © 2014 Perle Systems Limited All rights reserved. No part of this document may be reproduced or used in any form without written permission from Perle Systems Limited.