

IDS-710CT Managed Industrial Ethernet Switches

10-port Gigabit DIN Rail Switches with fixed fiber



- **8 x 10/100/1000Mbps RJ45 Ethernet Ports**
- **2 x Gigabit (1000Mbps) SC/ST Fiber ports**
- PROFINET and Modbus TCP protocols are supported for monitoring and device management
- **Ring Protocol MRP (IEC 62439-2)** has <10ms recovery time
- STP/RSTP/MSTP for network redundancy
- Advanced Security and IT management features: **TACACS+, RADIUS, 802.1x, SSH, SNMPv3, and HTTPS**
- **IEEE 1588 V1 and V2 PTP** for microsecond accuracy
- **Advanced protocols** to optimize the performance and intelligence of the network: IGMP Snooping, LLDP-MED, GVRP, Voice VLANs, MSTP, GMRP, and IPv6 MLD Snooping

The IDS-710CT is a ten-port Managed Ethernet Switch that can operate in industrial environments, providing advanced performance and enabling real-time deterministic network operation. Eight 10/100/1000-Base-T Ethernet ports are available for networking Gigabit and Fast Ethernet devices. The two 1000Base-X fiber connectors can **extend Gigabit Ethernet operating distances over fiber up to 160km (100 miles)**.

Using fiber is essential in settings that frequently experience high electromagnetic interference (EMI), such as industrial plants. This interference can cause data corruption over copper-based Ethernet links. However, data transmitted over fiber optic cable is immune to this noise ensuring optimal data transmission across the plant floor. Perle Industrial-grade Ethernet Switches are designed to withstand extreme temperatures, surges, vibrations, and shocks in industrial automation, government, military, oil and gas, mining, and outdoor applications. These rugged fanless switches are hardened to provide superior reliability in -10 to 60°C. Or choose the IDS-710-XT, where every component has been designed and tested to handle operating temperatures between -40 and 70°C.

With over 20 models, the Perle IDS-710CT offers an extensive choice of connectors, fiber types, temperature support, and operating distances. The simple Plug and Play installation in Perle's Fast Setup feature gets your Ethernet devices networked immediately. The familiar Command Line Interface (CLI), via in-band Telnet or the out-band serial console port, will be appreciated by CCNA (Cisco Certified Network Associate) and CCNP (Cisco Certified Network Professional) trained engineers.

The IDS-710 Managed Switches possess top-notch features suitable for enterprise environments that require extensive security, QoS, and network integration functionalities. They can be managed with an IPv6 address and supports a comprehensive set of management functions, including MRP (IEC62439-2), PROFINET, Modbus TCP, management VLAN, **Management Access Lists, Password Strength requirements**, RMON, N:1 port mirroring, and local alert log.

All Perle Industrial Ethernet Switches only use high-end components from the leading chip manufacturers to ensure the highest durability and reliability. In addition, all units have a corrosion-resistant aluminum case and dual redundant power input with reverse polarity and overload protection.

Perle has been designing industrial hardware since 1976. We used this expertise to develop the toughest Ethernet switches on the market that will keep your system running for years.

IDS-710CT Industrial Managed DIN Rail Switch Features

Simple deployment

Zero-touch discovery using Dynamic Host Control Protocol (DHCP), Perle's "Fast Setup" for first time installation, provides simple deployment in Ethernet environments

Security

802.1X, port security, Secure Shell (SSHv2); SNMPv3 provides encrypted administrator traffic during CLI and SNMP sessions; **TACACS+ and RADIUS** authentication facilitate centralized control and restrict unauthorized users.

Resiliency

- STP, RSTP and MSTP protocols for fast recovery.
- **MRP (IEC 62439-2)** for fast convergence in industrial ring networks. Prevents a switch loop scenario with recovery time of 10 ms or better.
- Perle's **P-Ring protocol** for configuring a ring network using standard spanning tree protocols.
- Link Standby is a link recovery feature for two links that provides a simple alternative to spanning tree protocols for link redundancy
- Buffered Real Time Clock backup

Manageability

- Web Device Manager, Telnet/SSH, HTTPS access, SNMP and Perle's **PerleView** NMS for centralized management
- In-band management via RJ45 or USB serial port
- Use an IPv4 or IPv6 address
- Removable MicroSD flash for configuration files and firmware backup and restoration

Industrial Ethernet Protocol Support

Manage Perle IDS-710 switches via PLC, NMS, HMI or SCADA systems using PROFINET or Modbus TCP.

Rugged design for harsh environments

- Corrosion resistant case
- Programmable Controller Safety certified
- Extended industrial temperature models

Reliable operation

- Fan-less, no moving parts
- Dual power input. Connect to separate power sources for redundancy.
 - Reverse polarity protection
 - Overload current protection
- Handles vibration and shock conditions found in industrial environments

Real-time Ethernet performance

- Fast wire-speed , store and forward switching
- Auto-sensing for speed and duplex
- Auto-mdi/mdix-crossover works with straight and crossover cables

Performance Features	
Port Auto-sensing	Auto-sensing of port speed and auto-negotiation of duplex on all switch ports for optimizing bandwidth
Auto MDI/MDIX	Medium-dependent interface crossover (Auto-MDIX) capability on 10/100 and 10/100/1000 mbps interfaces that enables the interface to automatically detect the required cable type (straight thru or crossover) and to configure the connection appropriately
802.3x flow control	IEEE 802.3x flow control on all ports. (The switch does not initiate pause frames)
Link Aggregation protocol	Increase port bandwidth through link aggregation. Support is provided for IEEE 802.3ad using Link Aggregation Control Protocol (LACP). Up to eight (8) ports in a single port-channel
Static Link Aggregation	Provides the ability to operate under a static (manual) link aggregation scenario (where the remote switch peer does not support LACP)
Storm Control	Storm control prevents traffic on a LAN from being disrupted by a broadcast, multicast, or unicast storm on one of the physical interfaces. A LAN storm occurs when packets flood the LAN, creating excessive traffic and degrading network performance. Storm Control enables limits to be placed on broadcast, multicast and unicast traffic

Bandwidth Control Monitoring	Bandwidth Control provides the ability to monitor the flow rates on a per port basis and the ability to cause an SNMP trap to occur (selectable) and put the port in an 'error-disabled' state
Static MAC Addressing	This feature enables the manual configuration of the MAC addresses on a per port basis. Flooding is prevented by retaining MAC entries across a reboot of the switch.
Port Blocking	Port Blocking provides the ability to block the flooding of unknown layer 2 unicast and multicast traffic on an Interface
IPV4 IGMP Snooping	Internet Group Management Protocol (IGMP) constrains the flooding of multicast traffic by dynamically configuring Layer 2 interfaces so that multicast traffic is forwarded to only those interfaces associated with IP multicast devices. IGMPv1, v2, v3, IGMP snooping querier mode, IGMP report suppression, topology change notification and robustness variable features are supported
IPV6 MLD Snooping	With Multicast Listener Discovery (MLD) snooping, IPv6 multicast data is selectively forwarded to a list of ports that want to receive the data, instead of being flooded to all ports in a VLAN. This list is constructed by snooping IPv6 multicast control packets
GMRP	GARP Multicast Registration Protocol (GMRP) provides a constrained multicast flooding facility similar to IGMP snooping. GMRP provides a mechanism that allows bridges and end stations to dynamically register group membership information with the MAC bridges attached to the same LAN segment and for that information to be disseminated across all bridges in the Bridged LAN that supports extended filtering services
Port Quick Disconnect	In some network environments, it is desirable to move an Ethernet from one switch port to another and have the device come on-line quickly. The Port Quick Disconnect feature if enabled, provides an immediate age-out of the MAC addresses learned on the port when the port status changes from a link-up to a link-down state
Manageability Features	
Network Assist	This Windows-based desktop application helps busy IT managers configure and monitor the status of deployed Perle devices.

Web Device Manager	The Perle Web Device Manager is an embedded Web based application that provides an easy to use browser interface for managing the switch. Operates with both http and secure https streams. Unlike competitive products, Java applet technology is not required or used
Command Line Interface (CLI)	A familiar text-based Command Line Interface that is based on accepted industry standard syntax and structure. Ideal for CCNA and CCNP trained engineers, this interface is available via in-band Telnet/SSH or the out-band serial console port
Industrial Ethernet Protocols	Manage Perle IDS-500 switches via PLC, NMS, HMI or SCADA systems using PROFINET or Modbus TCP .
SNMP	Manage the switch with an SNMP compatible management station that is running platforms such as HP Openview or Perle's PerleVIEW NMS. SNMP V1, V2C, V3
PerleVIEW	PerleVIEW is Perle's SNMP-based network management system that provides a view of the network with a large scale of Perle networking devices.
IPv6	Manage with an IPv4 or IPV6 address
DHCP Client Auto-Configuration	Automates configuration of switch information such as IP address, default gateway, hostname and Domain Name System (DNS) as well as TFTP server names. Firmware and configuration file locations are provided through options 54, 66, 67, 125 and 150
DHCP Relay	DHCP Relay is used for forwarding requests from DHCP clients when they are not on the same physical subnet. As a DHCP relay agent the switch operates as a Layer 3 device that forwards DHCP packets between clients and servers.
DHCP Option 82 Insertion	Normally used in metro or large enterprise deployments DHCP Option 82 insertion is used to provide additional information on "physical attachment" of the client. As per RFC 3046, option 82 enables additional pre-defined information to be inserted into the DHCP request packet (for DHCP Servers that support this option)

DHCP Server	For networks where a central DHCP server is not provided, the switch can provide a DHCP Server function for allocation of IP addresses to the connected devices
DHCP server port-based address allocation	<p>When Ethernet switches are deployed in the network, they offer connectivity to the directly connected devices. In some environments, such as on a factory floor, if a device fails, the replacement device must be working immediately in the existing network</p> <p>When configured, the DHCP server port-based address allocation feature ensures that the same IP address is always offered to the same connected port even as the client identifier or client hardware address changes in the DHCP messages received on that port</p>
LLDP	LLDP-Link Layer Discovery Protocol as per IEEE 802.1AB is a neighbor discovery protocol that is used for network devices to advertise information about themselves to other devices on the network. This protocol runs over the data-link layer, which allows two systems running different network layer protocols to learn about each other (via TLVs – Type-Length-Value)
LLDP-MED	LLDP Media Endpoint Discovery is an extension to LLDP that operates between endpoint devices such as IP phones and network devices such as switches. It specifically provides support for voice over IP (VoIP) applications and provides additional TLVs for capabilities discovery, network policy, Power over Ethernet, inventory management and location information
NTP	The switch can provide the time to NTP/SNTP capable client devices (or other switches, etc). You can run the SNTP client and the NTP server concurrently on your system. Therefore you can obtain time from an outside source and serve that time to the devices connected to the switch.

IEEE 1588 – PTP (Precision Time Protocol)	<ul style="list-style-type: none"> • IEEE 1588 V1 and V2 • Boundary Clock V1 • Boundary Clock V2 • End-to-End Transparent Clock Sync Two Step Operation • End-to-End Transparent Clock Sync One Step Operation • Peer-to-Peer Transparent Clock • End-to-end Boundary clock • Peer-to-peer boundary clock • Microsecond accuracy
File Download	Firmware can be transferred via TFTP, SCP, HTTP, HTTPS or via insertion of a microSD card. Text-based files that can be created or edited by common text editors.
Secure Copy Protocol (SCP)	SCP based on the Secure Shell (SSH) protocol, is a means of securely transferring computer files between a local host and a remote host or between two remote hosts.
Availability and Redundancy Features	
Spanning Tree Protocol (STP)	IEEE 802.1D now incorporated in IEEE 802.1Q-2014, STP prevents bridge loops and the broadcast radiation that results from them. Other Spanning Tree features include BPDU guard, Root guard, loop guard, root guard and TCN Guard
Rapid Spanning Tree Protocol (RSTP)	Interoperable with STP, RSTP (IEEE 802.1w) takes advantage of point-to-point wiring and provides rapid convergence of the spanning tree. Reconfiguration of the spanning tree can occur in less than 1 second
Multiple Spanning Tree Protocol (MSTP)	Originally defined in IEEE 802.1s and now incorporated IEEE 802.1Q-2014, defines an extension to RSTP for use with VLANs. The Multiple Spanning Tree Protocol configures a separate Spanning Tree for each VLAN group and blocks all but one of the possible alternate paths within each Spanning Tree.
MRP	<ul style="list-style-type: none"> • Media Redundancy Protocol (IEC 62439-2). • Fast convergence protocol designed for industrial networks. Recovery time of 10 ms or better in rings composed of up to 14 switches. • Prevents a switch loop scenario in a ring topology.

P-Ring	P-Ring provides an easy to use method for configuring a ring network using standard spanning tree protocols. Prevents a switch loop scenario in a ring topology.
Link Standby	A link recovery feature using a primary and backup link. Provides a simple alternative to spanning tree protocols for link redundancy
VLAN Features	
VLAN Range	Up to 256 VLANS across a VLAN ID range of 1 to 4000
GVRP	Generic Attribute Registration Protocol (GARP) VLAN Registration Protocol (GVRP) is an application defined in the IEEE 802.1Q standard that allows for the control of VLANs. With GVRP, the switch can exchange VLAN configuration information with other GVRP switches, prune unnecessary broadcast and unknown unicast traffic, and dynamically create and manage VLANs on switches that are connected through 802.1Q trunk ports.
Voice VLANs	Voice VLANs enables one to separate, prioritize, and authenticate voice traffic moving through your network, and to avoid the possibility of broadcast storms affecting VoIP (Voice-over-IP) operation. With an IP Phone connected to an access port, a switchport voice VLAN enables the use of one VLAN for voice traffic and another VLAN for data traffic from an Ethernet device attached to the phone
VLAN Interfaces	Perle switches provide the ability to configure management VLAN interfaces. This enables network administrators to access the switch's management interface from separate VLAN networks

Security Features	
IEEE 802.1X	<ul style="list-style-type: none"> • Provides secure access to switch ports from a central RADIUS server. The switch operating as an authenticator interacting with an 802.1X compliant supplicant (PC or industrial device) through the use of the EAPOL protocol. Authentication will be granted/denied through an external RADIUS server. • RADIUS assigned VLAN <ul style="list-style-type: none"> ◦ IETF 64 (Tunnel Type) ◦ IETF 65 (Tunnel Medium Type) ◦ IETF 81 (Tunnel Private Group ID) • Guest VLAN and Restricted VLANs are supported • For non-802.1X devices found in industrial applications, the switch can use the client MAC address for authorization through the use of MAB (MAC Authentication Bypass) • Switch can also be configured as an 802.1X supplicant (edge switch) with an 802.1x-aware upstream switch
Login Banner and MOTD	<ul style="list-style-type: none"> • A login message banner presented during sign-on can be configured by the network administrator. • A Message Of The Day can also be created for presentation to an authenticated user.
Password Strength Checking	<p>Many organizations require stringent management over the strength level of their passwords. When enabled, Perle extends this capability to local passwords stored on the switch enforcing strong passwords to be used.</p>
Port Security – Secure MAC Addresses	<p>This port security feature provides the ability to restrict input to an interface by limiting and identifying MAC addresses of the stations allowed to access the port (Access or Trunk) and will take specific actions when violations occur.</p>
Management ACL	<p>Restricting access to management functions can be configured by protocol or IP address selection are provided. This enables administrators to allow only specific workstations using particular protocols to be able to access the management functions of the switch</p>
RADIUS Management Access Authentication	<p>AAA support for RADIUS servers that Authenticate, Authorize and Account management sessions</p>
TACACS+ Management Access Authentication	<p>AAA support for TACACS+ servers that Authenticate, Authorize and Account management sessions</p>

Secure Socket Layer (SSL)	SSL provided for secure browser sessions using HTTPS
Secure Shell (SSH)	SSH provided for secure SSH session for CLI and SCP file transfer sessions
SNMPV3	Support provided for secure version 3 of SNMP
Quality of Service (QoS) and Class of Service (CoS) Features	
Classification	IP ToS/DSCP and IEEE 802.1p CoS
Congestion Avoidance	Weighted Fair Queuing or Strict Queuing
Egress Queues and scheduling	<ul style="list-style-type: none"> • 4 traffic class queues per port • output queue mapping • DSCP to output queue mapping
Monitoring Features	
Port Mirroring	N:1 Port Mirroring is a method of monitoring network traffic. With port mirroring enabled, the switch sends a copy of one or more ports to a predefined destination port. Selection of Transmit, Receive frames or both can be made
RMON	RMON statistics provided for statistics, history, alarms and events for network monitoring and traffic analysis
Syslog	Facility for logging systems messages to an external SYSLOG server
Alert Log	Facility for logging systems messages locally
Traceroute	Layer 2 traceroute to identify the path that a frame takes from source to destination
Virtual cable test	A test that enables the detection of potential copper cabling issues such as pair polarity pair swaps and excessive pair skew as well as any opens, shorts or any impedance mismatch. Will report the distance in the cable to the open or short.
SFP Diagnostics and Monitoring	Interface provided to the SFP's Digital Optical Monitoring facility to monitor operational or physical operating status of the SFP and link

Power Supply Monitoring	Provides the status of power supplies of the switch
Internal Temperature Monitoring	The internal ambient temperature of the switch can be obtained from the management interfaces
Alarm Processing	<p>The switch can monitor global switch conditions as well as individual ports. These alarms can be configured to send messages to :</p> <ul style="list-style-type: none"> • an internal log file • external Syslog server • SNMP trap server • An external alarm device such as a bell, light or other signaling device via the switch's built-in dry contact alarm relay <p>Global Status Monitoring Alarms</p> <ul style="list-style-type: none"> • Dual power supply alarm <p>Port Status Monitoring Alarms</p> <ul style="list-style-type: none"> • Link Fault Alarm (IE loss of signal) • Port not forwarding alarm • Port not operating alarm (failure upon start up tests) • FCS Bit error rate alarm
Alarm Relay	When enabled, energizes the built-alarm relay triggering an external alarm circuit such as a bell, light or other signaling device according to alarm conditions set
Management and Standards	
IEEE Standards	<ul style="list-style-type: none"> • IEEE 802.3 for 10Base-T • IEEE 802.3u for 100BaseT(X) and 100BaseX • IEEE 802.3ab for 1000Base-T • IEEE 802.3z for 1000BaseX • IEEE 802.3x for Flow Control • IEEE 802.1D-2004 for Spanning Tree Protocol • IEEE 802.1w for Rapid STP • IEEE 802.1s for Multiple Spanning Tree Protocol • IEEE 802.1Q for VLAN Tagging • IEEE 802.1p for Class of Service • IEEE 802.1X for Authentication • IEEE 802.3ad for Port Trunk with LACP • IEEE 802.1AB LLDP • IEEE 1588v1 PTP Precision Time Protocol • IEEE 1588v2 PTP Precision Time Protocol

Hardware Features & Technical Specifications: IDS-710CT Industrial Managed Ethernet Switches

Power	
Dual Power Input	<p>Both inputs draw power simultaneously. If one power source fails, the other live source can, acting as a backup, supply enough power to meet the operational needs of the switch.</p> <p>12/24/48 VDC Nominal. (9.6 to 60 VDC)</p> <p>Common negative</p>
Power & Alarm Connector	<p>8-Pin Removable Terminal Block.</p> <p>Grounding screw on metal chassis</p> 
Maximum Current Consumption @24 vDC	0.25 amps
Maximum Power Consumption @24 vDC	6 watts
Overload Current Protection	Fused overload current protection
Reverse polarity protection	The positive and negative inputs can be reversed providing safe and simple power connectivity.
Access Ports	
USB Serial Console port	MicroUSB Type B female port for serial console management. Used as an alternative port for out-of-band management connections
RJ45	<ul style="list-style-type: none"> • 8 shielded RJ45 ports for 10/100/1000Base-T up to 100 meters (328 ft) • Auto-negotiation • Auto-MDI/MDIX-crossover for use with either crossover over straight-through cable types • Ethernet isolation 1500 V

Gigabit Fiber Port	<ul style="list-style-type: none"> • Duplex SC or ST connector <ul style="list-style-type: none"> ◦ Multimode 50/125 or 62.5/125 micron fiber cable ◦ Single mode 9/125 micron fiber cable • Simplex (BIDI, single strand) SC connector <ul style="list-style-type: none"> ◦ Multimode 50/125 or 62.5/125 micron fiber cable ◦ Single mode 9/125 micron fiber cable • PC and UPC type patch cords supported.
Alarm Relay	
<ul style="list-style-type: none"> • NO (Normally Open) dry contact. • 1A @ 24V 	
Switch Properties	
Microprocessor Frequency	ARM Cortex A8 600MHZ
RAM & Flash	4GB DDR3 & 4GB eMMC
Standards	<ul style="list-style-type: none"> • IEEE 802.3 for 10Base-T and 2500Base-T • IEEE 802.3ab for 1000Base-T • IEEE 802.3z for 1000BaseX and 2500BaseX • IEEE 802.3u for 100Base-TX and 100Base-FX • Energy Efficient Ethernet (EEE) as per 802.3az. • IEEE 802.3x for Flow Control • IEEE 1588 – 2008 (in software only) • 802.1x
Processing Type	Store and Forward
MAC Address Table Size	8K
VLAN ID range	1 to 4000
IGMP groups	1024
Packet Buffer Memory	1 Mbit
Jumbo Frame Size	10 KB

Indicators	
System	Indicates whether the switch O/S is operating normally
RJ45 Ethernet	These integrated colored LEDs indicate link, activity and speed for each port.
Fiber Link	Fiber link LED indicates Link and Data Activity
Alarm	The alarm LED (Red) will be turned on under alarm conditions
Reset	Once pushed all 4 LEDs are solid Red for 3 seconds
Environmental Specifications	
MTBF	250009 Hours <i>Calculation model based on MIL-HDBK-217-FN2 @ 30°C</i>
Operating Temperature Ranges	<ul style="list-style-type: none"> IDS-710: -10°C to 60°C (14°F to 140°F). IDS-710-XT: -40°C to 70°C (-40°F to 158°F)
Storage Temperature Range	-40°C to 85°C (-40°F to 185°F)
Operating Humidity Range	5% to 90% non-condensing
Storage Humidity Range	5% to 95% non-condensing
Maximum Heat Output	27 Btu/hr
Operating Altitude	Up to 3,048 meters (10,000 feet)
Chassis	Metal with an IP20 ingress protection rating

Din Rail Mountable	<p>DIN Rail attachment included. Mounts to standard 35 mm DIN rail in accordance with DIN EN 60175.</p> <p>Removable to accommodate optional Panel/Wall mount kit</p> 
Product Weight and Dimensions	
Weight	0.35 kg / 0.77 lb
Dimensions (W x H x D)	45 x 93 x 109 mm / 1.77 x 3.66 x 4.29 in
Packaging	
Shipping Weight	0.50 kg / 1.1 lb
Shipping Dimensions	25 x 17 x 7 cm / 9.84 x 6.7 x 2.75 in
Standards and Certifications	
Laser Safety	<ul style="list-style-type: none"> • EN 60825-1 • Fiber optic transmitters on this device meet Class 1 Laser safety requirements per IEC-60825 FDA/CDRH standards and comply with 21CFR1040.10 and 21CFR1040.11.
Safety	<ul style="list-style-type: none"> • CE Mark • UL/IEC 61010-1 and UL/IEC 61010-2 • UL/EN/IEC 62368-1 • CAN/CSA C22.2 No. 62368-1
Emissions	<ul style="list-style-type: none"> • FCC 47 Part 15 Class A, EN55032 (CISPR32) Class A • ICES-003 • EN61000-6-4 (Emissions for industrial environments) • CISPR 32:2015/EN 55032:2015 (Class A) • CISPR 24:2010/EN 55024:2010 • EN61000-3-2

EMC and Immunity	<ul style="list-style-type: none"> • CISPR 24 / EN55024 • CISPR 32 / EN55032 • IEC/EN 61000-4-2 (ESD) : Contact discharge +/- 4kv, Air discharge +/- 8kv • IEC/EN 61000-4-3 (RS) : 80mhz to 16hz ; 20v/m, 1.5hkhz to 2.0ghz ; 10 v/m, 2.0ghz to 2.7 ghz ; 5 v/m • IEC/EN 61000-4-4 (EFT) : DC power line +/- 2kv, data line +/- 1kv • IEC/EN 61000-4-5 (Surge) : DC power line, Line/Line +/- 1kv, Line/Earth +/- 2kv, data line /earth +/- 2kv • IEC/EN 61000-4-6 (CS) :150mhz-80mhz 10vrms • IEC/EN 61000-4-8 (Magnetic Field) :30 A/M • EN 61000-4-11 • IEC/EN 61000-6-2 (General Immunity in Industrial Environments)
Environmental	Reach, RoHS and WEEE Compliant
Other	<ul style="list-style-type: none"> • ECCN: 5A992 • HTSUS Number: 8517.62.0020 • 5 years Warranty
Contents Shipped	<ul style="list-style-type: none"> • Industrial Ethernet Switch with DIN Rail attachment • Terminal block • Installation guide

Select a Model to obtain a Part Number: IDS-710CT

Model	Fiber Type	Fiber Connector	Transmit (dBm)		Receive (dBm)		Power Budget (dB)	Wavelength (nm) TX / RX	IEEE	Core Size (um)	Modal Bandwidth (MHz* Km)	Maximum Operating Distance
			Min	Max	Min	Max						
IDS-710-T2MD05-XT	MMF	2 x Duplex ST	-9.5	-4	-17	-3	7.5	850	1000Base-SX	62.5	160	220 m (722 ft)
										62.5	200	275 m (902 ft)
										50	400	500 m (1,640 ft)
										50	500	550 m (1,804 ft)
										50	2000	1000 m (3281 ft)

IDS-710-C2MD05-XT	MMF	2 x Duplex ST	-9.5	-4	-17	-3	7.5	850	1000Base-SX	62.5	160	220 m (722 ft)
										62.5	200	275 m (902 ft)
										50	400	500 m (1,640 ft)
										50	500	550 m (1,804 ft)
										50	2000	1000 m (3281 ft)
IDS-710-C2MD2	MMF	2 x Duplex ST	-6	0	-17	0	11	1310	1000Base-SX	50	500	1 km (3280ft)
										62.5	160	2 km (1.2 mi)
IDS-710-T2MD2	MMF	2 x Duplex ST	-6	0	-17	0	11	1310	1000Base-SX	50	500	1 km (3280ft)
										62.5	160	2 km (1.2 mi)
IDS-710-T2SD10-XT	SMF	2 x Duplex ST	-9.5	-3	-20	-3	10.5	1310	1000Base-LX/LH	9	**	10 km (6.2 mi)
IDS-710-C2SD10-XT	SMF	2 x Duplex SC	-9.5	-3	-20	-3	10.5	1310	1000Base-LX/LH	9	**	10 km (6.2 mi)

Single Fiber (Simplex / BiDi) Models Recommended use in pairs

Model	Fiber Type	Fiber Connector	Transmit (dBm)		Receive (dBm)		Power Budget (dB)	Wavelength (nm) TX / RX	IEEE	Core Size (um)	Modal Bandwidth (MHz* Km)	Maximum Operating Distance
			Min	Max	Min	Max						
IDS-710-C2MS05U	MMF	2 x Simplex SC	-10	-4	-17	-3	7	1310/1550	1000Base-BX-U	62.5	500	500 m (1640 ft)
IDS-710-C2MS05D	MMF	2 x Simplex SC	-10	-4	-17	-3	7	1550/1310	1000Base-BX-D	50	500	500 m (1640 ft)

* 1db/km multimode fiber cable

** as per ITU-T G.652 SMF specifications

Do you need a longer distance? Contact us to discuss the options.

Application Diagrams

IDS-710CT Managed Industrial Ethernet Switches Diagrams

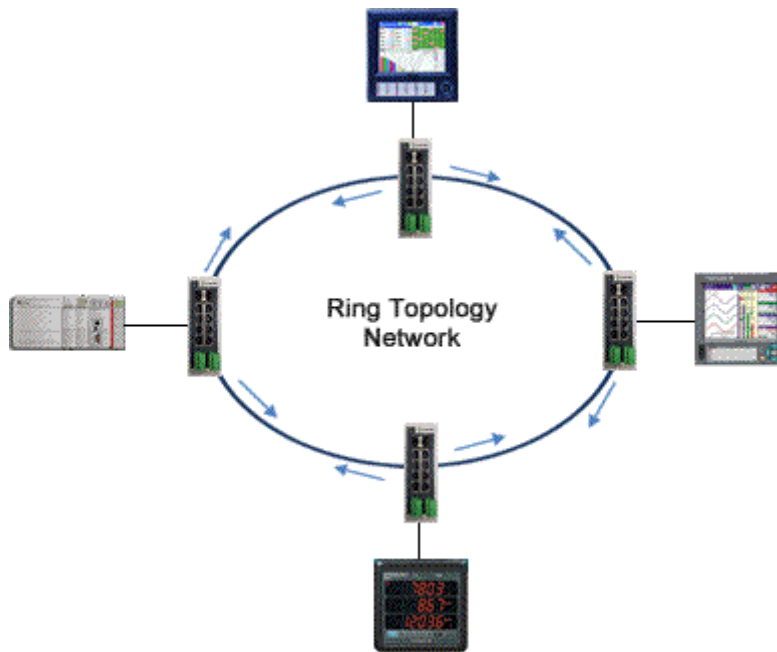
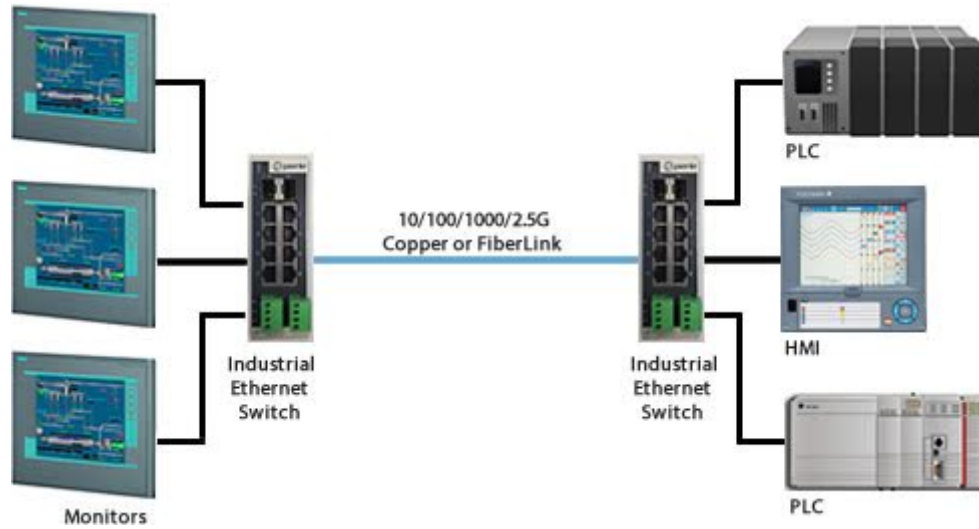

IDS-710CT Mechanical Drawing

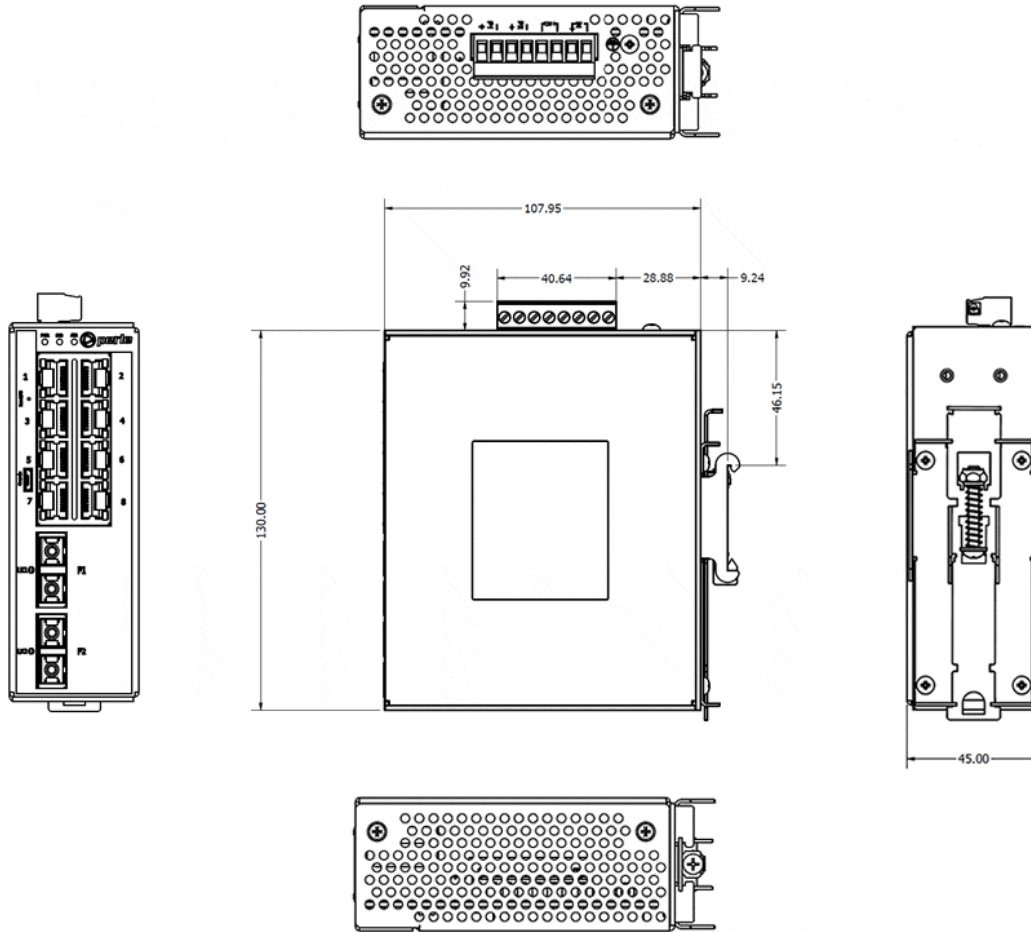

IDS-710CT DIN Rail Mounting Options

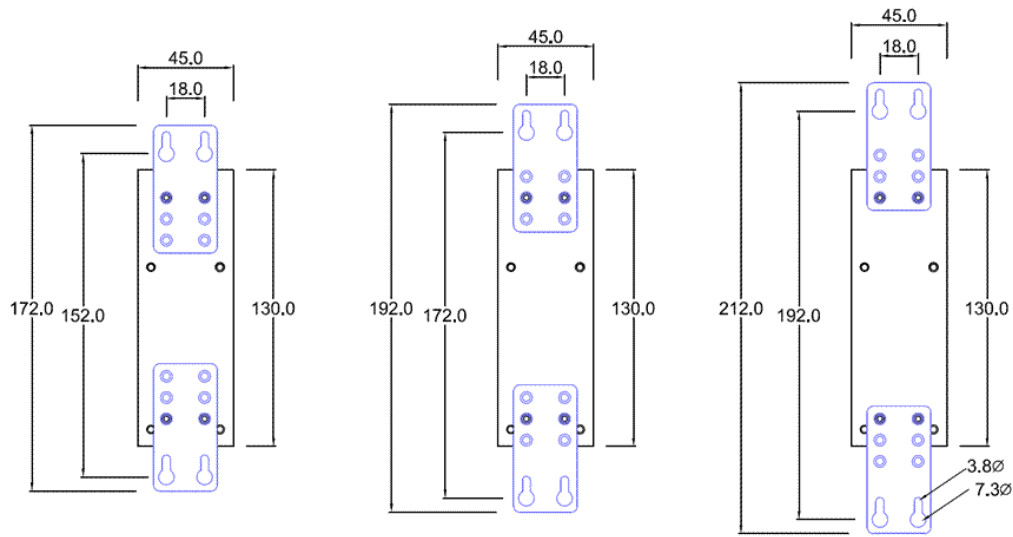

Single Mode/Single Strand (WDM) Fiber

Connecting devices over a single fiber strand (also referred to as “Bi-Directional” BiDi or Simplex)

To reduce costs, or where there are limits on available fiber, Wavelength-Division Multiplexing (WDM) technology may be utilized. WDM uses separate transmit and receive frequencies to communicate on a single fiber strand. WDM technology relies on the fact that optical fibers can carry many wavelengths of light simultaneously without interaction between each wavelength. Thus, a single fiber can carry many separate wavelength signals or channels simultaneously. WDM systems are divided into different wavelength patterns, conventional/coarse (CWDM) and dense (DWDM).

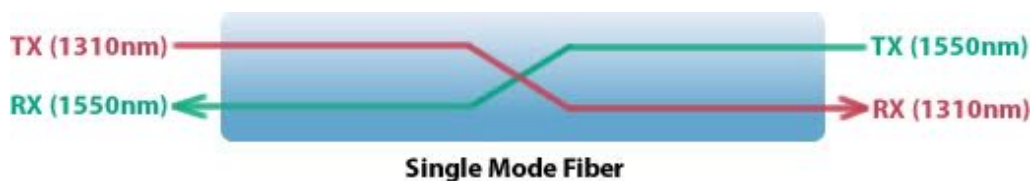

When Single Strand fiber is used, you will need an “Up” side and a “Down” side when interconnecting fiber devices.

Perle offers a wide variety of Single Fiber (“Up/Down”) **Ethernet Switches** and **Media Converters** for use with single strand of fiber.

Product List



IDS-710-C2MS05U - Industrial Managed Ethernet Switch with 10 ports: 8 x 10/100/1000Base-T RJ-45 ports and 2 x 1000Base-BX 1310nm TX /1550nm RX, Multimode, Single-Fiber (Bi-directional) with SC Simplex Connector [500 m/1640 ft]. -10 to 60C operating temperature. PRO software feature set

Power Cord & Part Number(s)

None

07017510



IDS-710-C2MS05D - Industrial Managed Ethernet Switch with 10 ports: 8 x 10/100/1000Base-T RJ-45 ports and 2 x 1000Base-BX 1550nm TX /1310nm RX, Multimode, Single-Fiber (Bi-directional) with SC Simplex Connector [500 m/1640 ft]. -10 to 60C operating temperature. PRO software feature set

Power Cord & Part Number(s)

None

07017520



IDS-710-C2MD05-XT - Industrial Managed Ethernet Switch with 10 ports: 8 x 10/100/1000Base-T RJ-45 ports and 2 x 1000Base-SX, 850nm Multimode, Dual fiber with SC Duplex Connector [550m/1804 ft]. -40 to 70C Industrial extended operating temperature. PRO software feature set

Power Cord & Part Number(s)

None

07017550



IDS-710-T2MD05-XT - Industrial Managed Ethernet Switch with 10 ports: 8 x 10/100/1000Base-T RJ-45 ports and 2 x 1000Base-SX, 850nm Multimode, Dual fiber with ST Duplex Connector [550m/1804 ft]. -40 to 70C Industrial extended operating temperature. PRO software feature set

Power Cord & Part Number(s)

None

07017560



IDS-710-C2MD2 - Industrial Managed Ethernet Switch with 10 ports: 8 x 10/100/1000Base-T RJ-45 ports and 2 x 1000Base-LX, 1310nm Extended Multimode, Dual fiber with SC Duplex Connector [2km/1.2 mi]. -10 to 60C operating temperature. PRO software feature set

Power Cord & Part Number(s)

None

07017570



IDS-710-T2MD2 - Industrial Managed Ethernet Switch with 10 ports: 8 x 10/100/1000Base-T RJ-45 ports and 2 x 1000Base-LX, 1310nm Extended Multimode, Dual fiber with ST Duplex Connector [2km/1.2 mi]. -10 to 60C operating temperature. PRO software feature set

Power Cord & Part Number(s)

None

07017580



IDS-710-C2SD10-XT - Industrial Managed Ethernet Switch with 10 ports: 8 x 10/100/1000Base-T RJ-45 ports and 2 x 1000Base-LX/LH, 1310nm, Single mode, Dual fiber with SC Duplex Connector [10 km/6.2 mi]. -40 to 70C Industrial extended operating temperature. PRO software feature set

Power Cord & Part Number(s)

None

07017630



IDS-710-T2SD10-XT - Industrial Managed Ethernet Switch with 10 ports: 8 x 10/100/1000Base-T RJ-45 ports and 2 x 1000Base-LX/LH, 1310nm, Single mode, Dual fiber with ST Duplex Connector [10 km/6.2 mi]. -40 to 70C Industrial extended operating temperature. PRO software feature set

Power Cord & Part Number(s)

None

07017640

Related Accessories



Panel Mount Kit PM3 - Brackets for wall or panel mounting 30 to 45mm wide Perle IDS Industrial Switches and IRG5140+ LTE Routers.

Model

Panel Mount Kit PM3

Part Number**07010290**

Rack Mount Kit RM4U - 4U Rack mount for mounting DIN Rail products to a 19 inch rack.

Model

Rack Mount Kit RM4U

Part Number**07010300**